

Six years ago

Things we didn't understand 6 years ago:

- details of star-formation – does it even matter anymore?
- Gas accretion in mergers vs. cosmological accretion
- Angular momentum in disks
- secular evolutionary processes - Where and when important?
- [M/H] mixing - instantaneous recycling & sources of gradients?
- AGN: maintenance vs. quenching, why exponential cutoff in mass
- Which came first: Galaxies or AGN?
- Stochasticity of star-formation in high redshift galaxies: What and why?
- Self-regulation/limited efficiency of star-formation: how?

3-D instruments are very effective for investigating galaxy evolution through archeology, relating the physics connecting a range of physical phases, and for observing galaxy evolution *in situ*, helping us to solve these problems

Philosophical Considerations

Two philosophical general views of science:

Reductionism (classical)

- Always look for underlying simplicity

like to use the words ...

"causality"

"symmetry"

"fundamental"

"insightful/genius"

physicists, chemistry, cell biology

holism/emergentism (modern)

- Connect processes through statistics and information theory

like to use the words ...

"complexity/organization"

"information"

"chaotic/non-linear/stochastic"

"propensity/irreducibility"

empirical physical sciences,
anthropology, medicine

Summary of Hopkins/Bournaud

$$P_{final}(k) = \Pi P_i(k)$$

$$P_{final}(k) = \Sigma P_i(k)$$

AGN + SF + accretion:
Turbulent pressure,
cosmic ray pressure, B-field
pressure, radiation pressure,
ionization, shocks, gravitational
instabilities

Central limit theorem  log-normal
+
wings

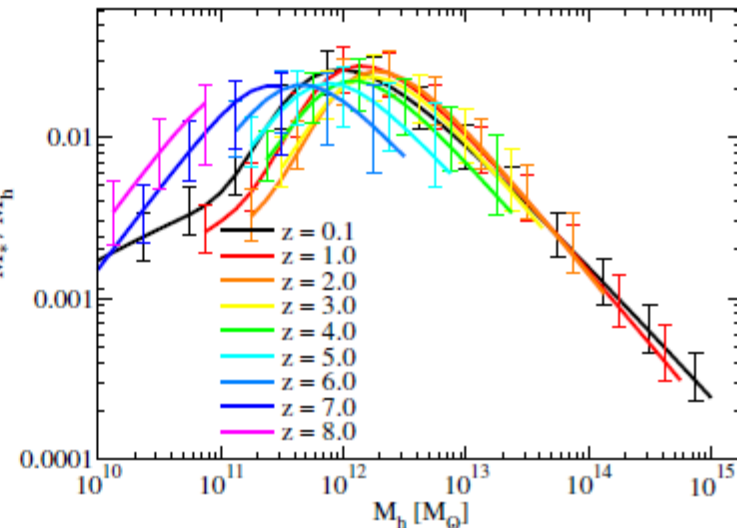
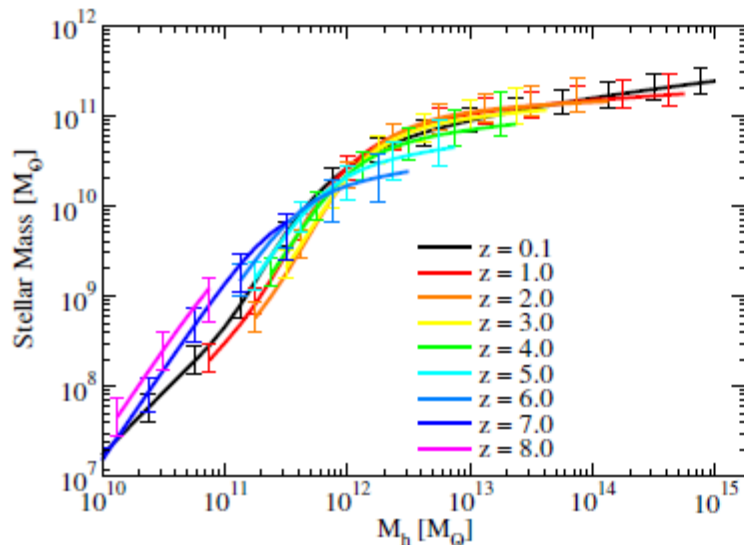

The right phase for the right job

Our technology is changing the way we “dream”:

I suggest that we used to have to force data to probe details it cannot.

van der Hulst:

- HI disks are excellent probes of galaxy structure & kinematics
spiral arms, warps, rotation curves, streaming motions, triaxiality,
...
- HI reveals physical processes not/hardly seen otherwise
tidal interactions, accretion/inflows, tidal/ram-pressure stripping,
Galactic fountain, ...

However, it is interesting perhaps that the WIM can probe turbulence at high redshift, or does it?

No evolution in ρ_{HI} What is the relationship between H_2 ? Is it the reservoir for star formation?

ETGs

Slow rotators

Weakly triaxial
No disk
Elliptical isophotes

fast rotators

disks
axisymmetric
disk E to S0 to
almost bulgeless S0

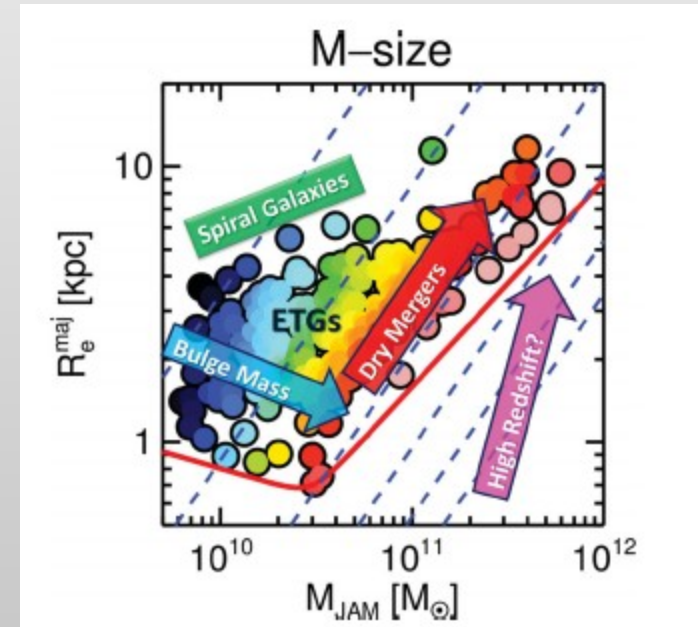
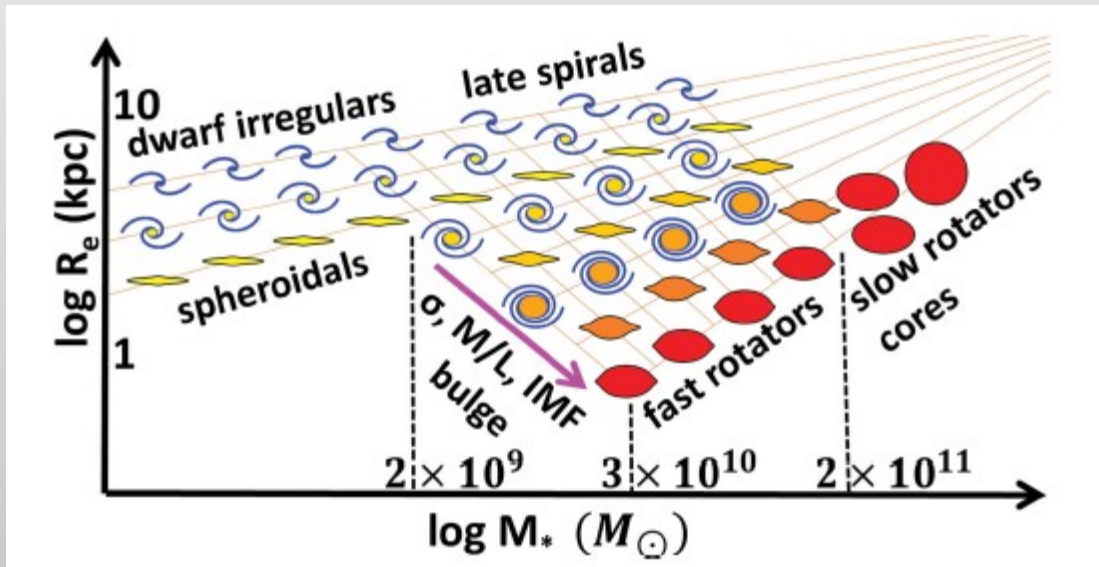

Does the IMF really vary systematically in ETGs?

ETGs

Slow rotators

Weakly triaxial

No disk

Elliptical isophotes

fast rotators

disks

axisymmetric

disk E to S0 to

almost bulgeless S0

- many paths to each of these endpoints
- dissipation and merger orbital characteristics play important roles
- not so much on merger mass fractions (surprising!)

But,

- accretion histories in cosmological simulations are:
 - sensitive to some not so well understood physics, e.g. feedback processes that are missing, e.g. ram pressure stripping
 - some galaxy characteristics, e.g. thin disks, are not well simulated.

Cosmological initial conditions means one is sensitive to the prescriptions used but the gain is that orbital families can be potentially linked to accretion history.

Are lenticulars faded spirals? $Sa \rightarrow S0$, yes? $Sb \rightarrow S0$, No $Sc \rightarrow S0$???

Actually, no! Internal or external processes but beware of the thin early type disks with high angular momentum.

ETGs - Gas

22% have CO emitting gas

Range of properties – disks(1/2), rings(15%), bars+rings (10%), ...
mildly and strongly distorted (~20%)

Most massive tend to host the disks – external origin likely

Tully-Fisher for ETGs – same slope but offset

H2 and WIM gas have same kinematics.

40% are detected in HI outside of Virgo – $5-50 \times 10^6 M_{\text{sun}}$

Majority in disk or rings and from small disks to very extended

Disks that are “cored”.

Relation to on-going star formation

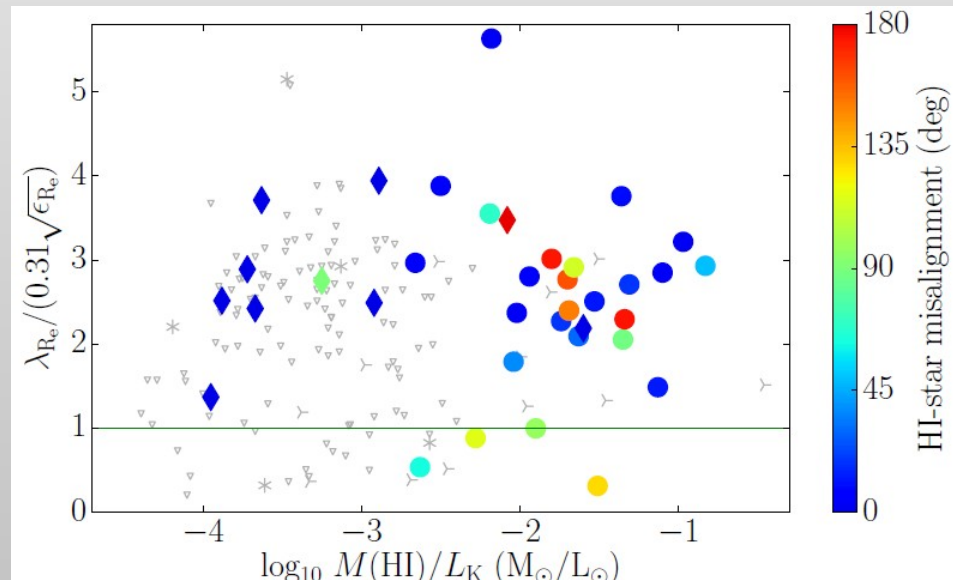

Transformational technologies

3D input devices

GPUs

Advanced visualization

The goal has to be to assess the information in the data quantitative way?

Not sure. Perhaps developing intuition and insight/comparing with automated selection may be worth the effort. After all, if everything could be done with computers, we wouldn't need visualization at all really.

Besides, inspiration and the love of bringing galaxies and large scale structure within our grasp is interesting too ... Bärbel.

Nuclear Star Clusters

How are galactic nuclei/bulges built? How do SMBHs grow? What is the relation between NSCs and SMBHs?



GALEX

Thilker et al. 2010

- Detected in 50-70% of all galaxies (LTGs?)
- Half light of 2-5 pc
- $M_{\text{stellar}} \sim 10^{6-7} M_{\text{sun}}$, high densities
- Range of stellar populations
- Some host SMBHs ($10^{5-6} M_{\text{sun}}$)
- MW hosts one

The GC of the MW is a fascinating lab for understanding the detailed stellar and gas dynamics – Stefan Gillessen's talk

Star formation – cloud structure

How important is external pressure? What do we mean by external pressure? High turbulence undoubtedly lead to efficient formation of dense gas – perhaps self-gravitating clouds, but could also lead to too much “turbulent support” - ie. the virial parameters (Krumholz and McKee). Starbursts: no, mergers: yes, spiral: yes ... I'm confused.

No universal clouds – mixtures of active and inactive clouds and external pressure correlations with internal pressure (Σ and $\langle\sigma\rangle/R$ vary with environment). Are streaming motions important?

In nearby starbursts, the mach numbers of the gas flows are extremely high.

What about the relation between HI and CO emitting gas ... similar scale heights ... are molecular clouds transient?

Weighing disks

Define $F_{\max}^{\text{disk}} \equiv V_{\max}^{\text{disk}} / V_{\max}$

DMS sample average: $\langle F_{\max}^{\text{disk}} \rangle = 0.47 \pm 0.08$

Bershady+ 2011

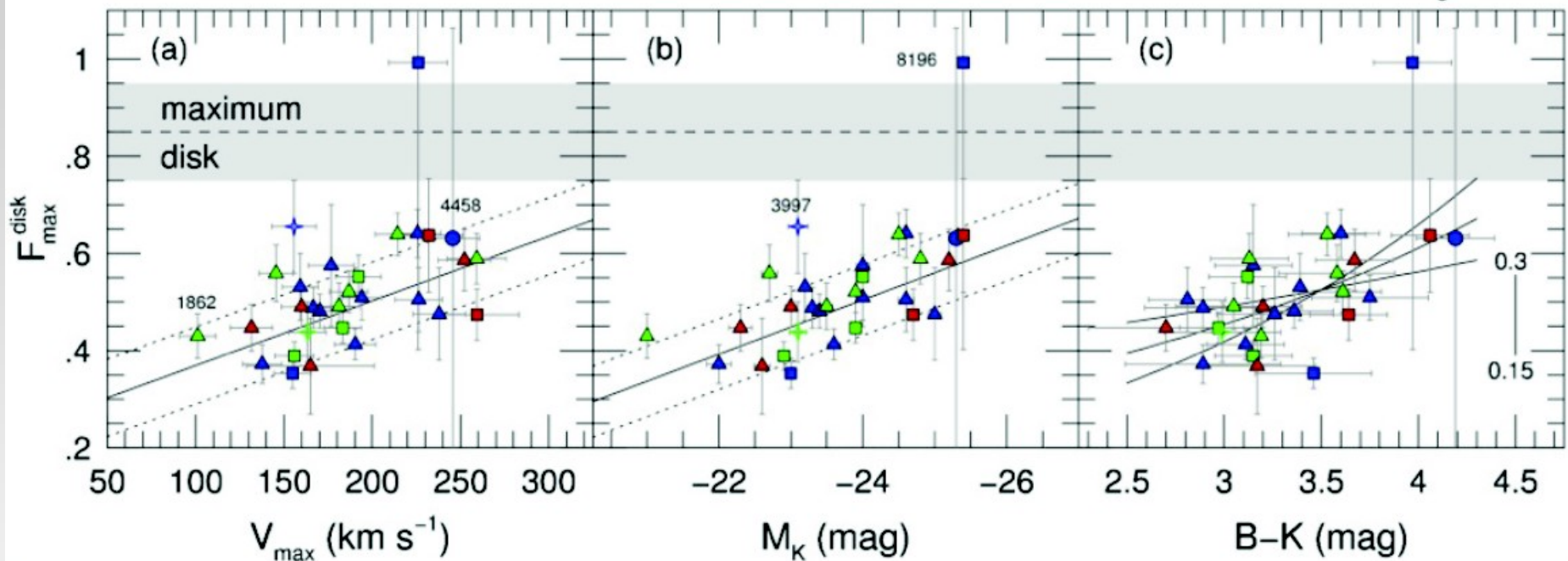

Trends: $F_{\max}^{\text{disk}} = (0.24 \pm 0.08) + (0.26 \pm 0.08)(V_{\max} / 200 \text{ km s}^{-1})$

$F_{\max}^{\text{disk}} = (0.50 \pm 0.07) - (0.06 \pm 0.02)(M_K + 24)$

Tully-Fisher slopes (3.4) and zero point, imply constant baryon fraction

Distant galaxies

Turbulence is incredibly important.

Finally see direct evidence for many of the processes that are likely important for driving galaxy evolution ...

- Outflows

- Inflows

- Distant stability

- Gas surface density – star formation intensity relation

Models and observations agree that star-formation is self-regulating, but how? [I was right!]

- Gravitational instability

- Turbulence

- Radiation pressure

- Cosmic rays (chemistry)

Nature of the clumps?

- Underlying hierarchical mass structure?

- Do they form thick disks? Bulges? SMBHs?

Underlying Mechanisms for AGN Feedback

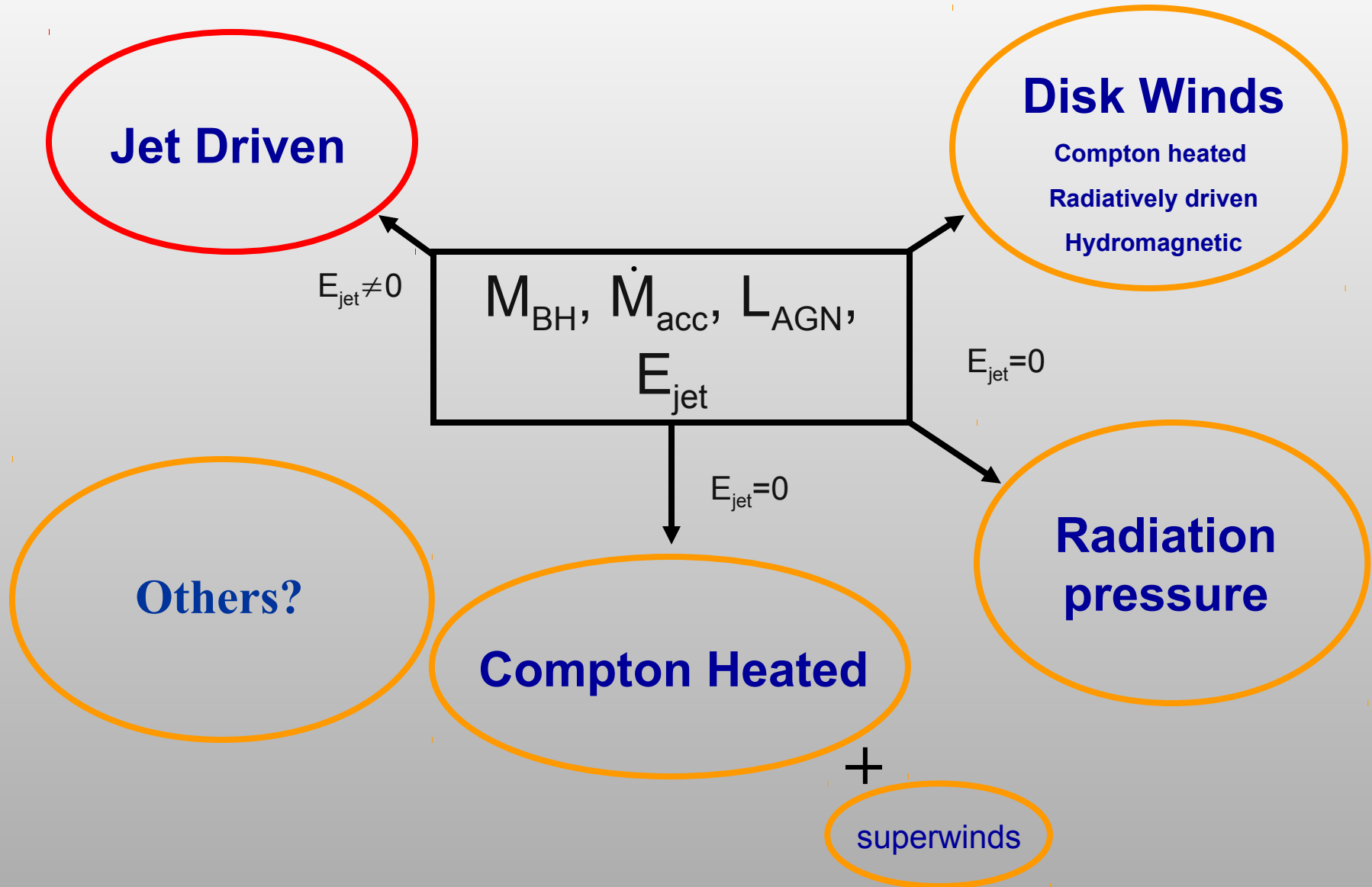

Influence of AGN

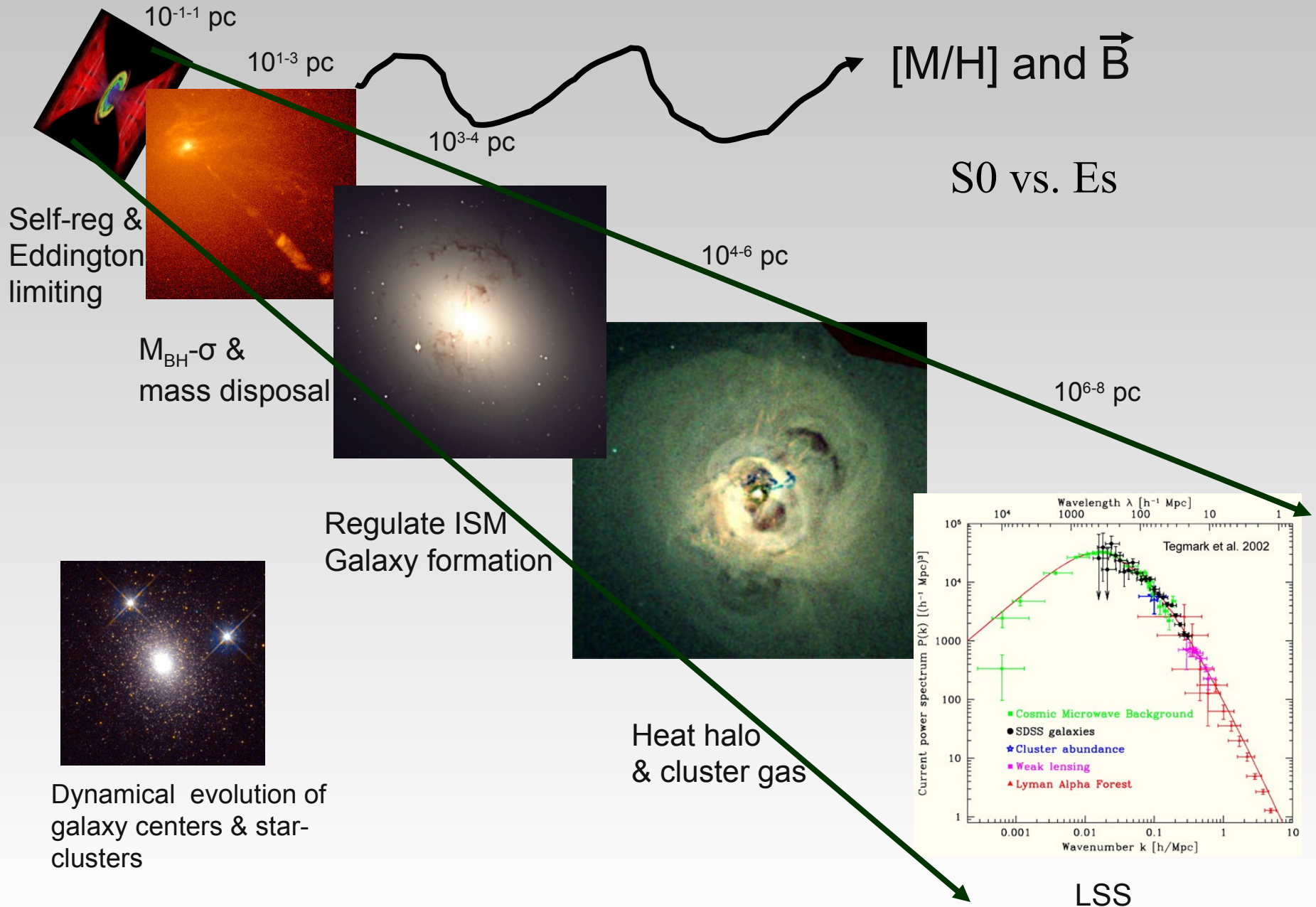

Physics of Winds

Outflows driven by the collective thermalization of stellar winds and supernova

Thermalization of SNe:
$$T_{\text{postshock}} = \frac{3}{16} v_{\text{ejecta}}^2 m_H / k = 9.1 \times 10^7 v_{\text{ejecta}, 2000}^2 K$$

Injection region:
$$T_c = 0.4 \mu m_H \dot{E}_{\text{total}} / k \dot{M}_{\text{total}}$$

$$\rho_c = 0.3 \dot{M}_{\text{total}}^{3/2} \dot{E}_{\text{total}}^{-1/2} R_{\text{SB}}^{-2}$$

$$v_\infty = \sqrt{2} \dot{E}_{\text{total}}^{1/2} \dot{M}_{\text{total}}^{-1/2}$$

$$\frac{\dot{M}_{\text{wind}}}{\text{SFR}} \neq \eta$$

Sne/SW are efficiently thermalized

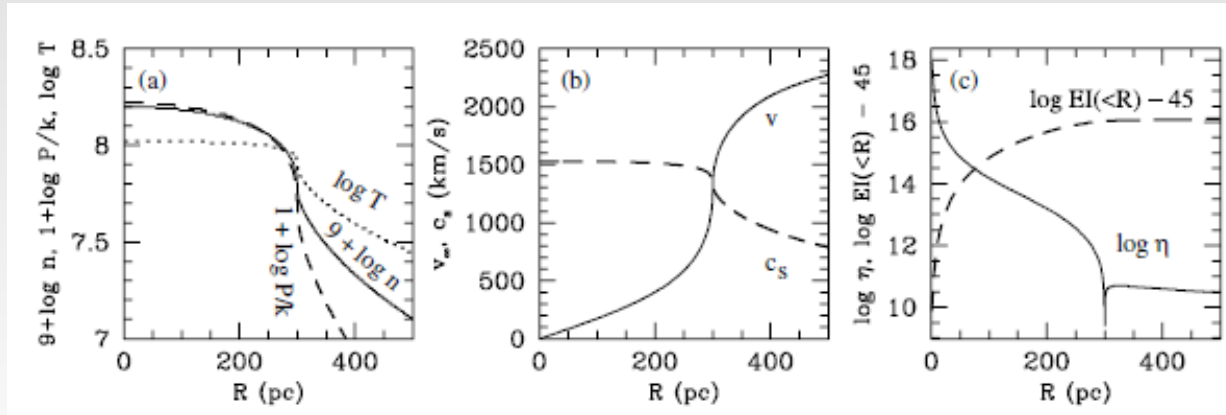

Only galaxies w/ $\Sigma_{\text{SFR}} > 0.05 M_\odot \text{ yr}^{-1} \text{ kpc}^{-2}$ drive winds

*Chevalier & Clegg (1985),
Strickland & Heckman (2009)*

Energetics

Equivalence of star-formation power to AGN

$$L_{\text{bol,BH}} = 1.2 \times 10^{45} \text{ erg s}^{-1} (M_{\text{BH}} / 10^8 M_{\text{s}}) (\epsilon_{\text{acc},1})$$

$$L_{\text{bol,SB}} = 7.4 \times 10^{44} \text{ erg s}^{-1} (M_{\text{SFR}} / 10^3 M_{\text{s}})$$

But the mechanical energy can be a 1-10% and depends on the mechanisms

Stars have the advantage in many ways closely associated with the gas and have plenty of radiation ... SNe becomes sound waves!

Momentum flux

Momentum flux depends on the terminal velocities of the most mass components and the AGN is like a “disk wind”/radio jet.

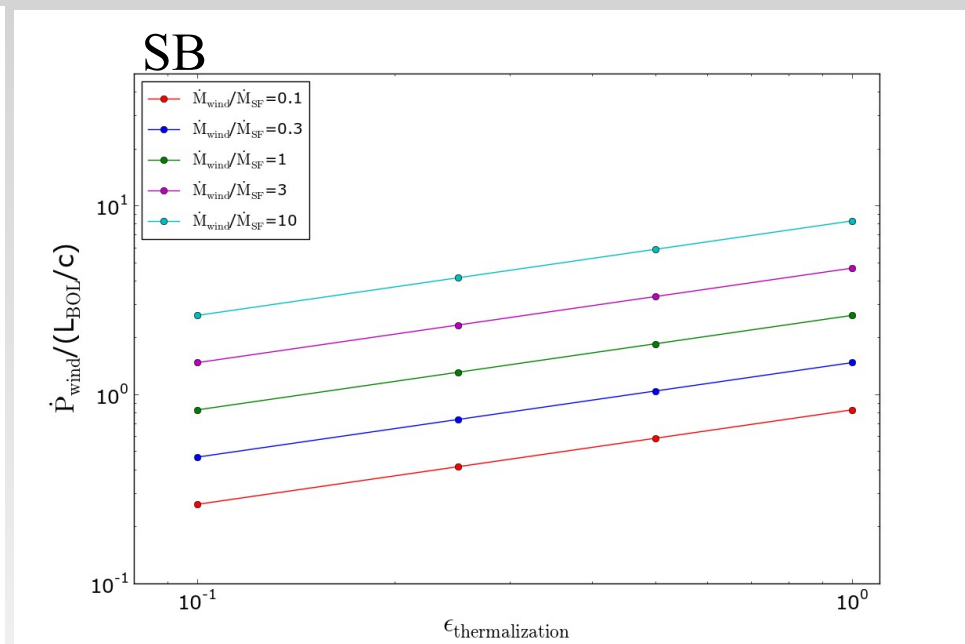
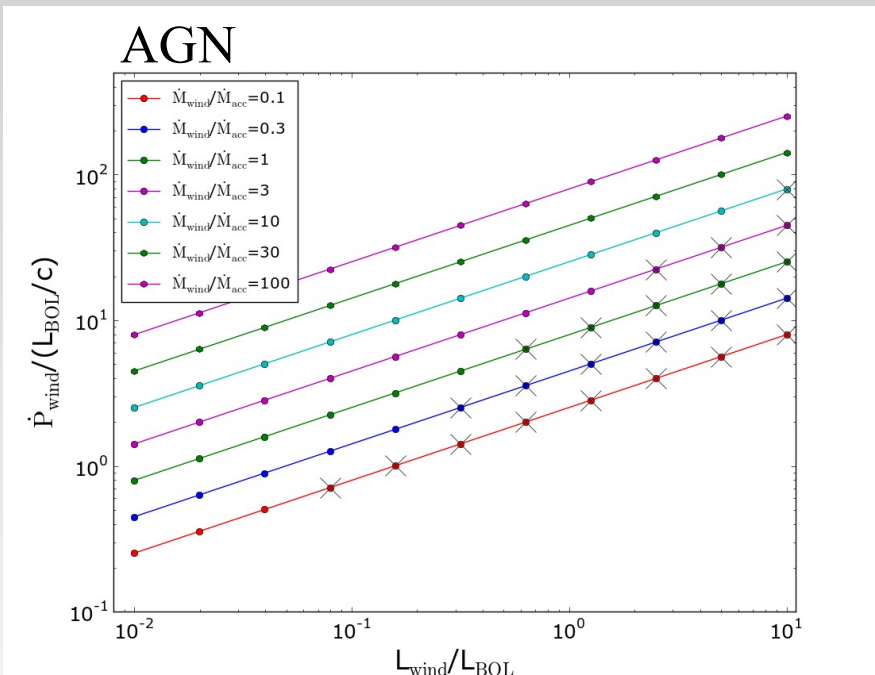

Escaping Wind in M82

Region of spatially coincident X-ray and H-alpha emission

Characteristics suggest fast shock of 800 km s^{-1} being driven in an ambient halo cloud. $V_{\text{shock}} > V_{\text{escape}}$



Escaping

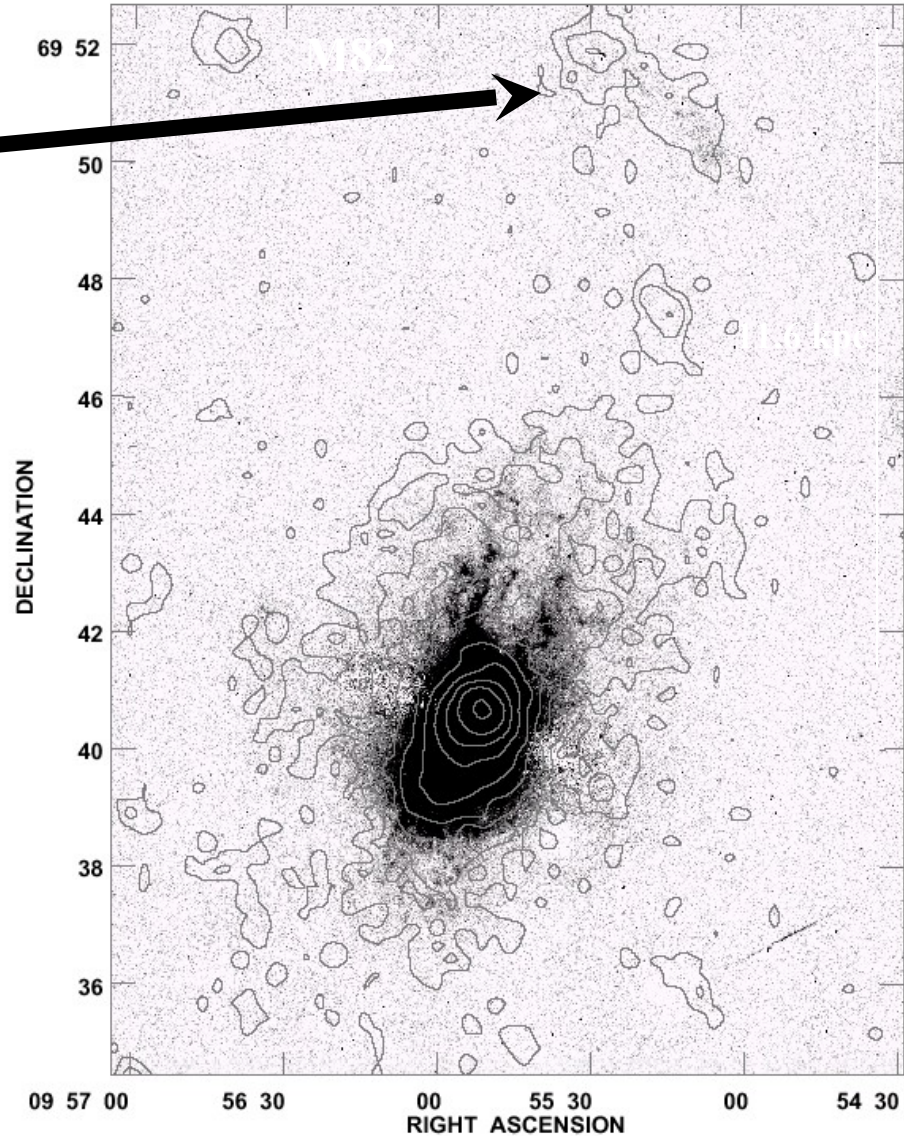

Lehnert, Heckman, & Weaver (1999)

Large Scale Feedback Cycle

The game is to find out where the energy goes ... dissipation vs advection

Ejected from halo

Cools and rains back down

Bulk flow of hot and warm ionized gas,
warm neutral gas, and warm molecular gas

Long dissipation time-settles
down and fuels BH

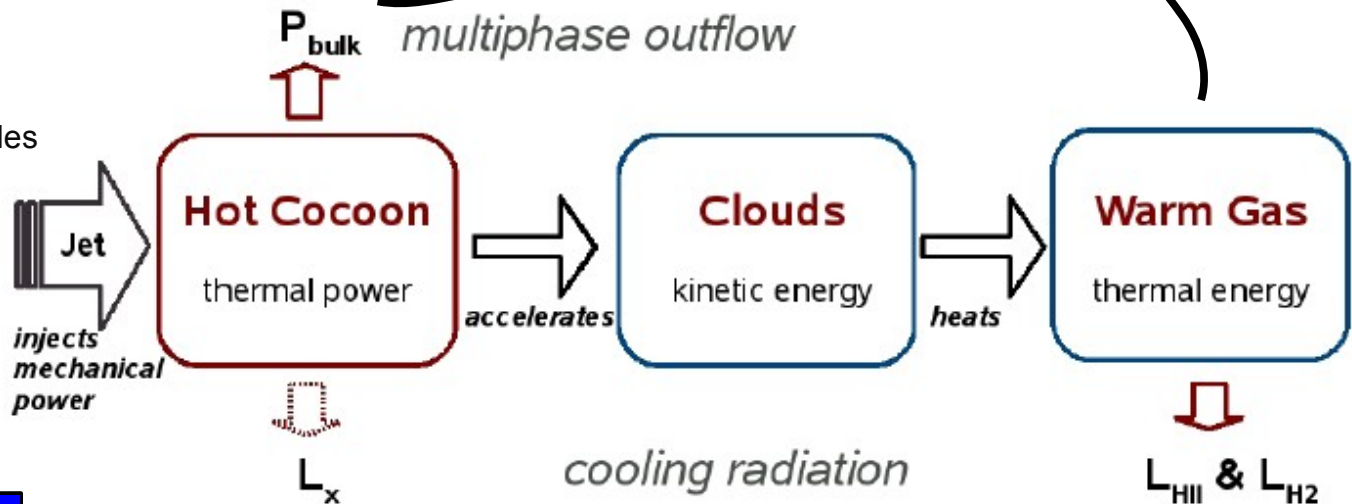

thermal Bremsstrahlung &
line cooling

Dissipation of mechanical
and thermal energy as
turbulent cascade down
to small scales and dense material

Cools through optical-IR atomic
recombination and molecular lines

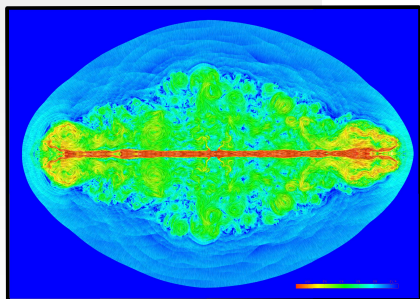

Random thoughts

Starburst driven winds tell us that the distribution of the phases is the only way of determining the heating, cooling, and dissipation ...

In analogy with stellar systems, heat capacity of gas can be positive or negative ...

Intense star formation, perhaps all star formation, is self regulating ...

What we think may drive the turbulence, bulk motions, and phase distribution of ISM depends on the dissipation timescales in the various phases ...

Outflows will never be as efficient as we need to completely remove the gas or suppress star formation completely ... beware of extreme rates, $t_{\text{depletion}} < 10^7$ years ... please stop pushing outflow rates higher!

And I don't know what to do with $\text{SFI} > 100\text{-}10000 \text{ Msun yr}^{-1} \text{ kpc}^{-2}$

Discoveries are built on technology+patience

SINFONI – high throughput (+longslits)
simple optics/stability (sky subtraction)
KMOS – low res SINFONI on steroids

MUSE – Wow! Truly imaging spectroscopy

Herschel – PACS IFU

ALMA – excellent site, builds on PdBI, CARMA, SMA ...

Aperitif – LOFAR – SKA precursors – SKA

CALIFA, SAMI, ALFALFA, MANGA, VIRUS

We owe a great thanks to the people who put their time into making these discoveries possible ... they let us “dream”.