

Prospects for studying resolved stellar populations with the E-ELT

Joe Liske
E-ELT Science Office



The E-ELT

- 40-m class telescope: largest optical-infrared telescope in the world
- Segmented primary mirror
- Active optics to maintain collimation and mirror figure
- Adaptive optics assisted telescope
- Diffraction limited performance
- Wide field of view: 10 arcmin
- Mid-latitude site (Armazones in Chile)
- Fast instrument changes
- VLT level of efficiency in operations

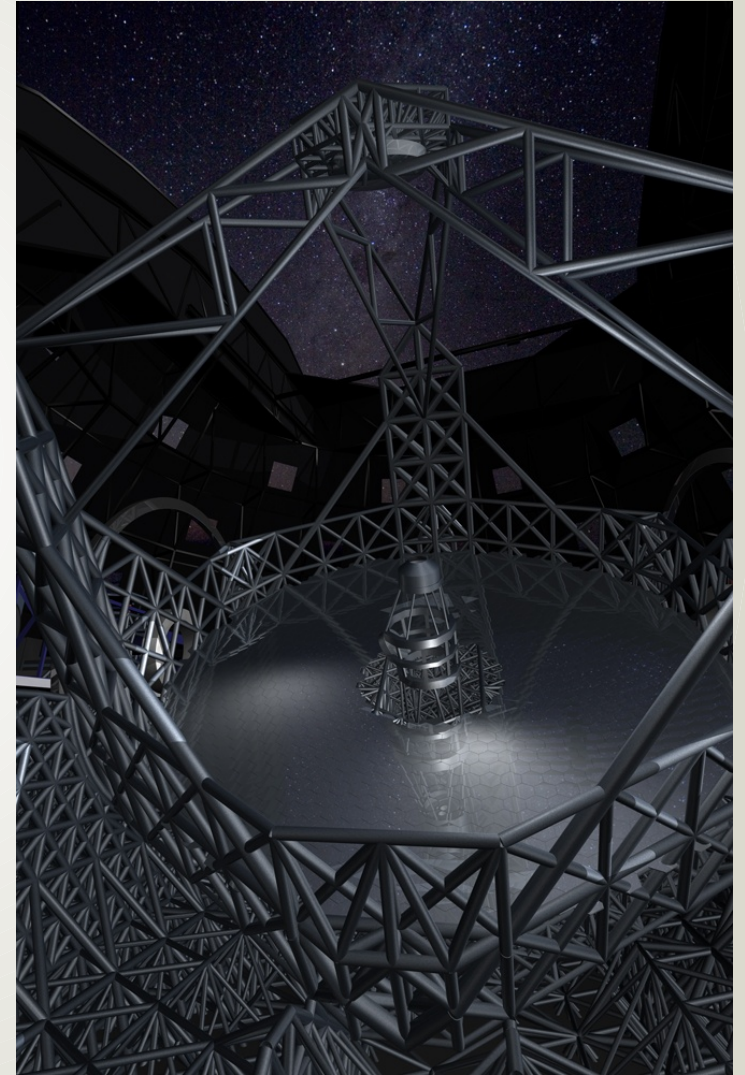

Current status in a nutshell

- Top priority of European ground-based astronomy (on Astronet and ESFRI lists).
- Project (led by ESO) completed its detailed design phase (Dec 2006 - Dec 2010), with a total budget of 62 M€ from ESO + 35 M€ from EC Framework Programmes (FP6/FP7).
- Final Design Review passed in Sep 2010.
- 8 instrument + 2 AO module concept studies completed.
- Site selected: Cerro Armazones in Chile.
- Dec 2010 – Jun 2011: Delta Phase B: exploring options to reduce cost and risk.
- **Recent development (Jun 2011):** change of baseline design.
- Construction planned to begin in 2012.
- Start of operations early next decade.
- Construction cost: ~1 B€ (incl first-light instrumentation).

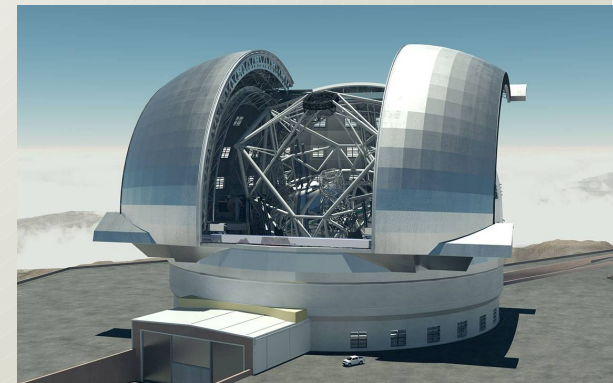
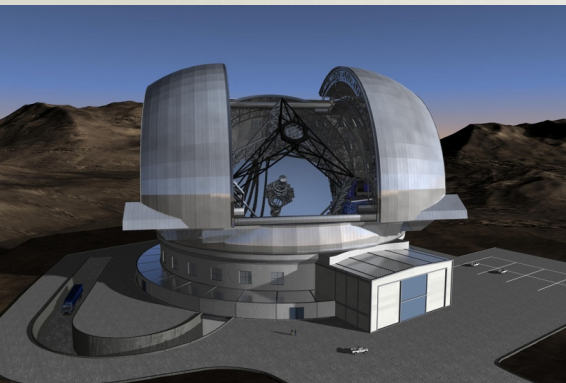

Most recent developments

- In June 2011 ESO Council endorsed a revised baseline design for the E-ELT.
- The overall concept of the original design remains unchanged.
- Main changes:

- Reduction of primary mirror diameter by removing two rings of segments:

	<u>Largest fully enclosed D</u>	<u>Circumscribing D</u>	<u>Area</u>	<u>Segments</u>
Original 42-m design:	41.3 m	43.2 m	1212 m ²	984
New design:	37.0 m	39.3 m	978 m ²	798

- Faster f-ratio.
- Loss of gravity invariant focal station.

- Instrumentation plans and budget remain unchanged.

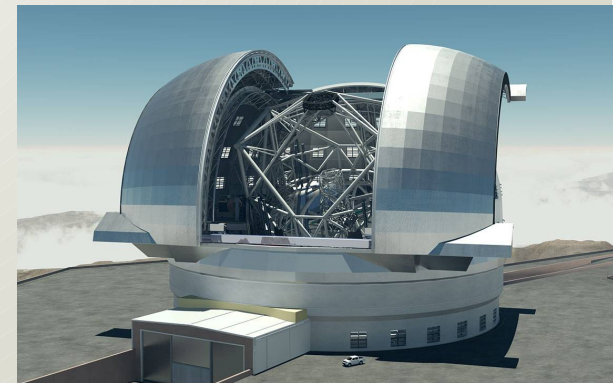
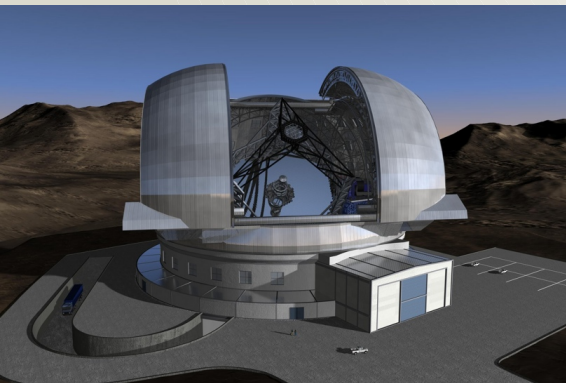

The Telescope

- Nasmyth telescope with a segmented primary mirror.
- Novel 5 mirror design to include adaptive optics in the telescope.
- Classical 3-mirror anastigmat + 2 flat fold mirrors (M4, M5).

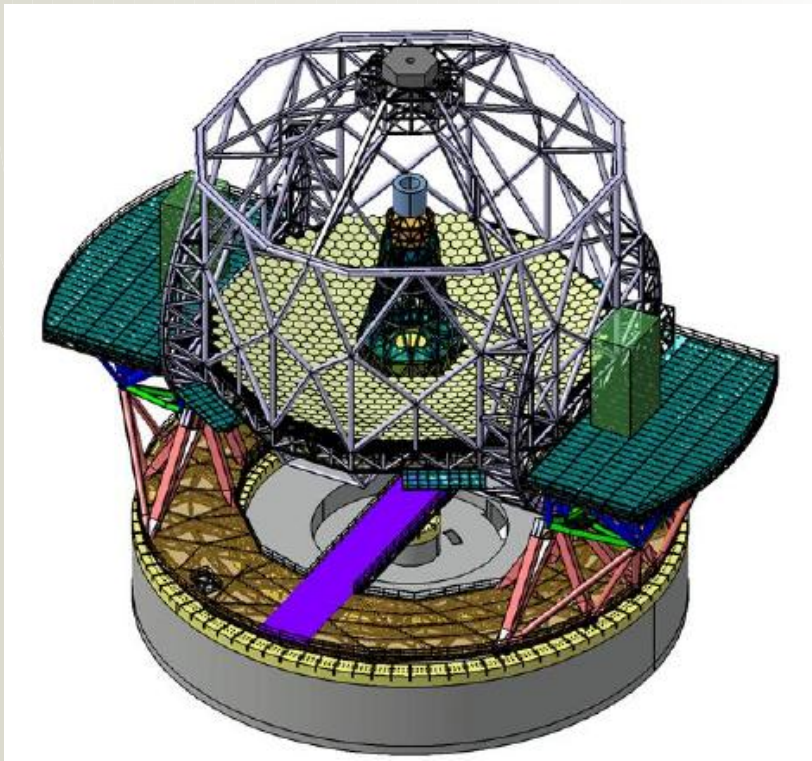
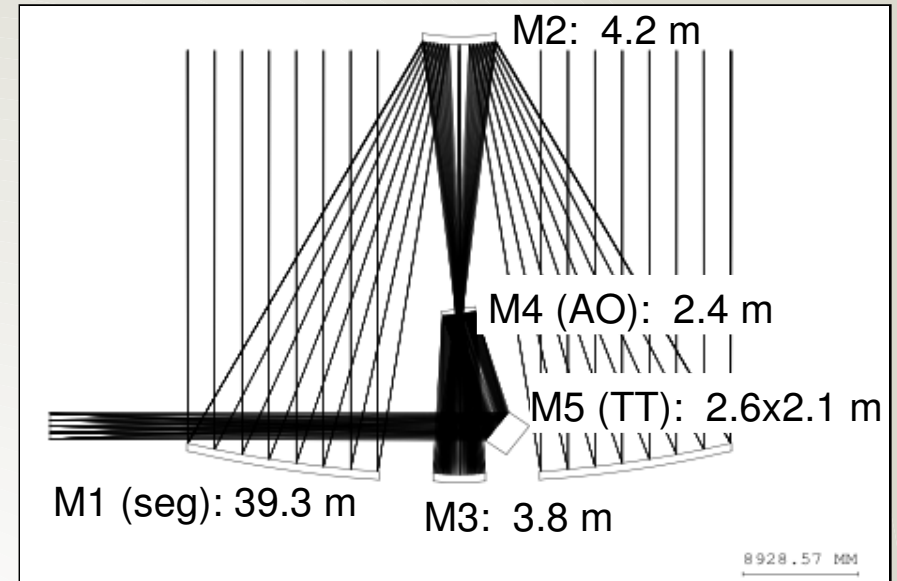

- Two instrument platforms nearly the size of tennis courts can host 3 instruments each + Coudé lab.
- Six laser guide stars (provisions for eight), launched from the side.
- Nearly 3000 tonnes of moving structure.

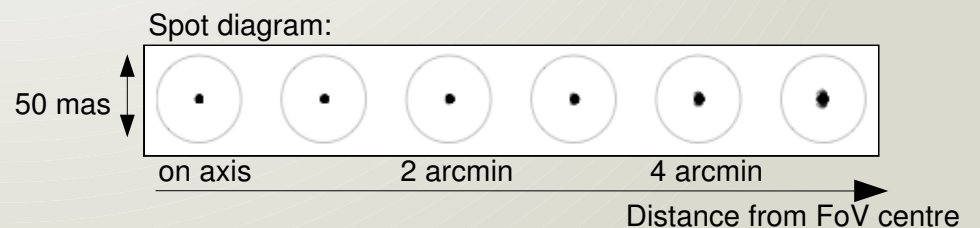

The Mirrors

M1: 39.3 m, 798 hexagonal segments of 1.45 m tip-to-tip: 978 m² collecting area

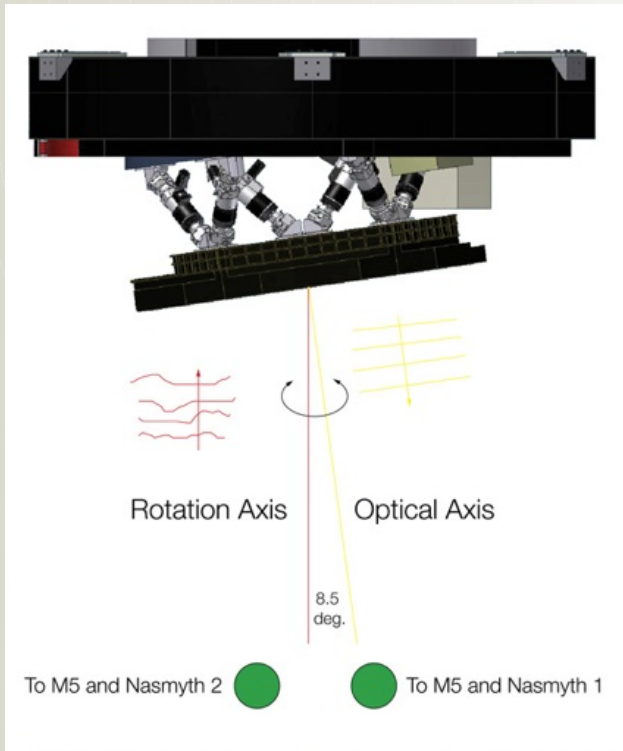
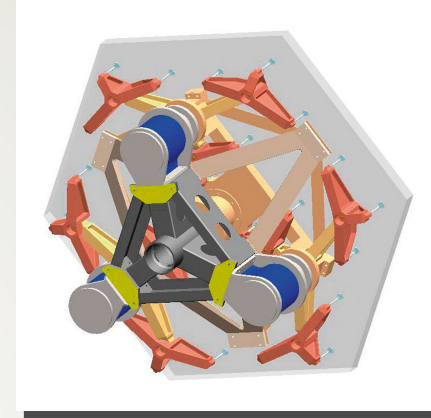
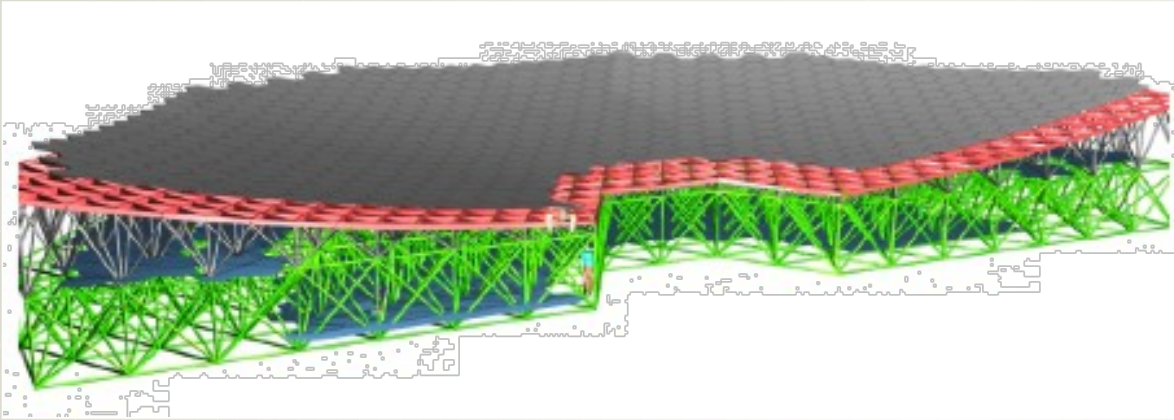

M4: 2.4 m, flat, adaptive
6000 to 8000 actuators

M5: 2.6 x 2.1 m, flat,
provides tip-tilt correction

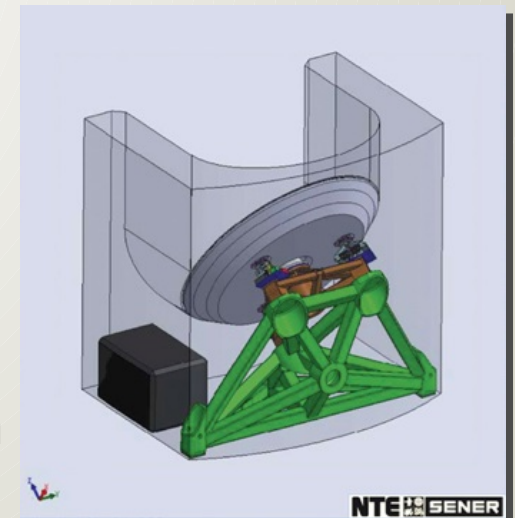

The Dome

- Rather classical design.
- Diameter = 86 m, height = 74 m.
- ~3000 tonnes of steel.
- Fully air-conditioned and wind shielded.

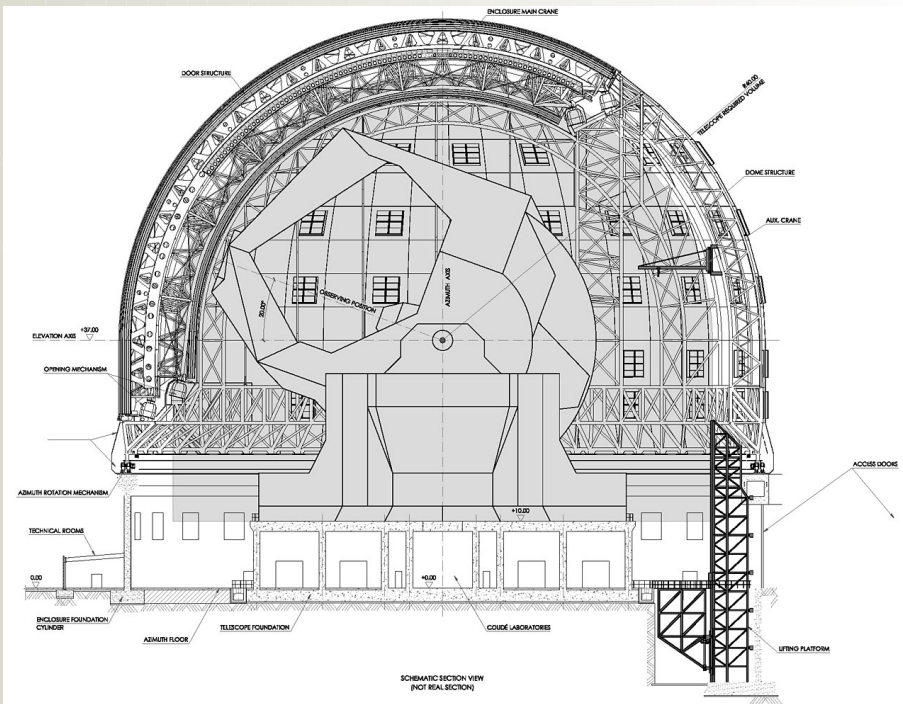
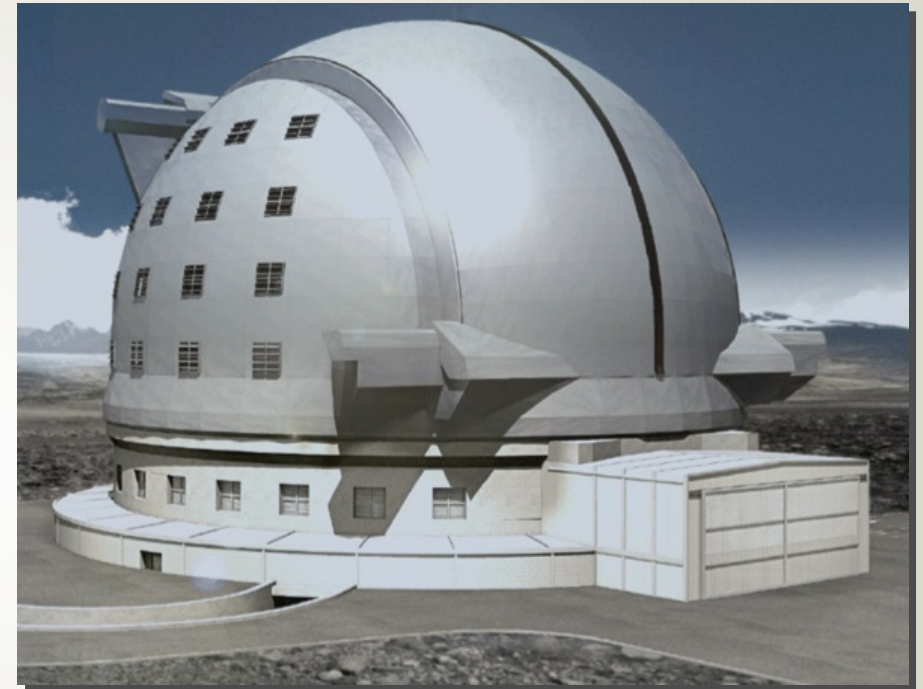

Instrumentation

In principle, the telescope can host up to 8 instruments:
3 on each Nasmyth platform, 2 in the Coudé lab.

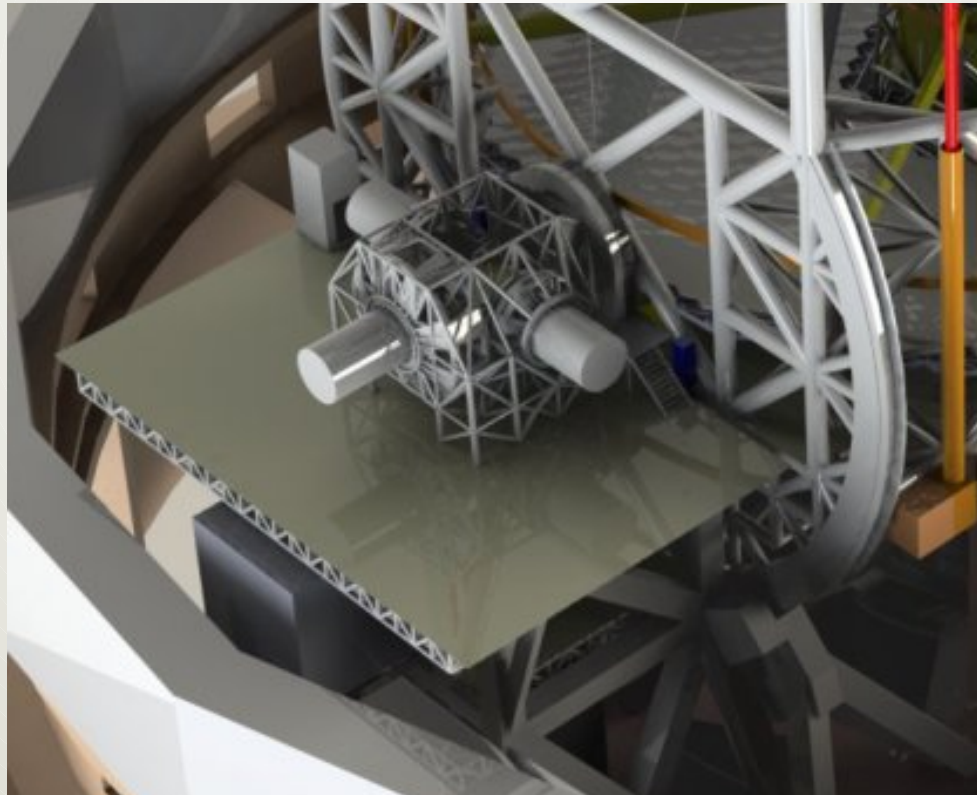

Instrumentation

Instrument and AO modules Study Plan (April 2007):

- Goal: definition of a first generation instrument set to be included in the E-ELT construction proposal.
- Scope:
 - Carry out a suitable number of instrument studies to verify that instruments can be built at an affordable cost and that they properly address the scientific goals of highest priority.
 - Work with the ESO community in studying 8 instruments + 2 AO modules and to prepare for construction.
 - Work with with telescope and operation POs to identify and define interfaces with the other subsystems and the observatory infrastructure.
- Budget: 2.3 M€ (2007-2010).

Instrumentation

- 8 instrument concept (phase A) studies
- 2 post-focal adaptive optics module studies

- Scope

- Detail the science case.
- Finalize the instrument requirements.
- Develop an instrument concept including cost and construction schedule.

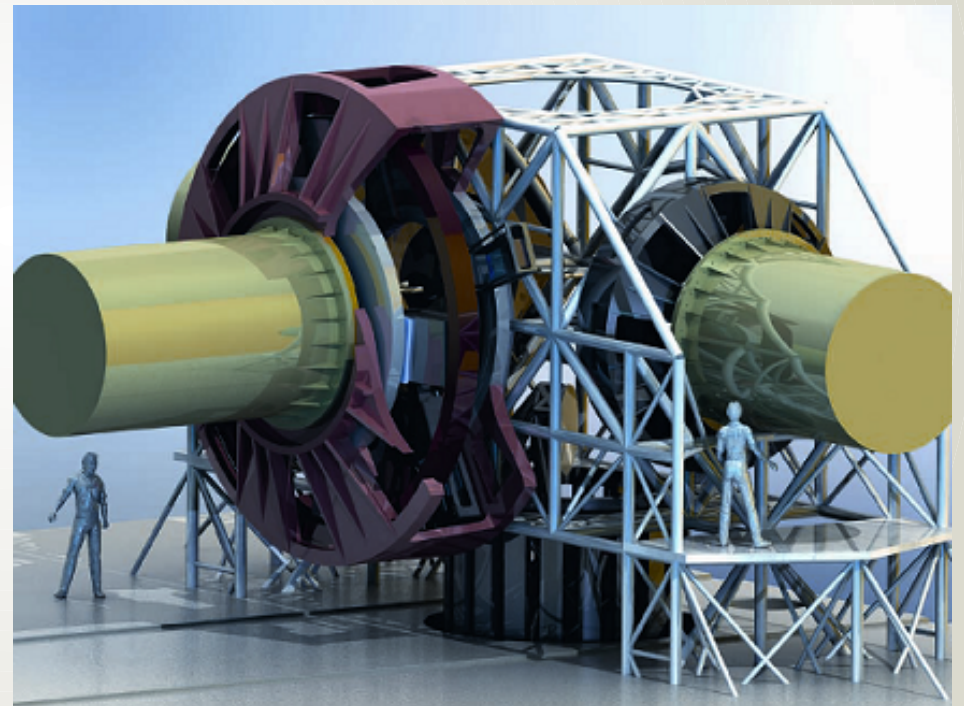

- All phase A studies were successfully completed by early 2010.

Phase A studies

CODEX	High-resolution, high-stability optical spectrograph
EAGLE	Wide-field NIR multi-IFU
EPICS	Extreme AO planet imager and spectrograph
HARMONI	Single field NIR wide-band IFU
METIS	MIR imager and spectrograph
MICADO	Diffraction limited NIR imager
OPTIMOS	Wide-field optical MOS
SIMPLE	High-resolution NIR spectrograph
ATLAS	Laser Tomography AO module
MAORY	Multi Conjugate AO module

Parameter space covered by phase A studies

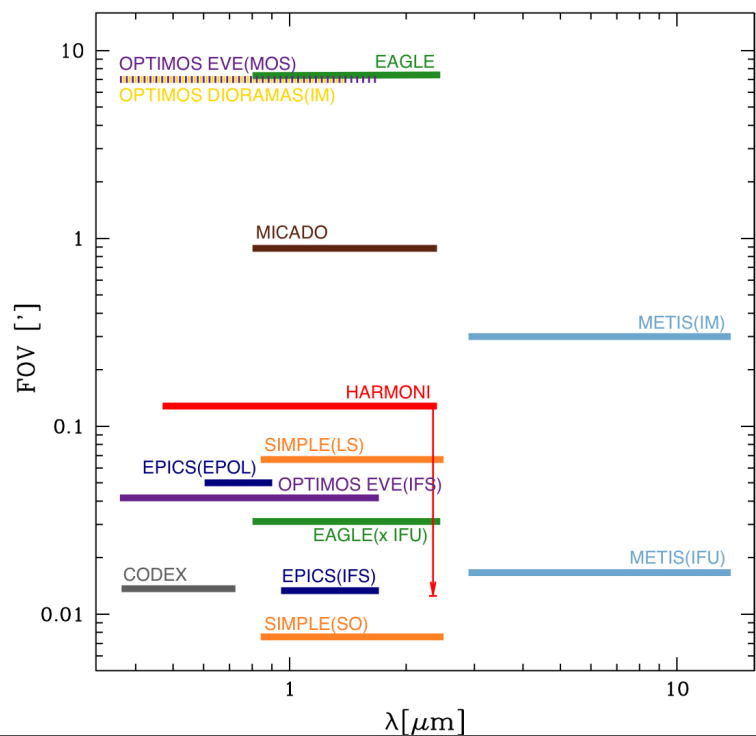
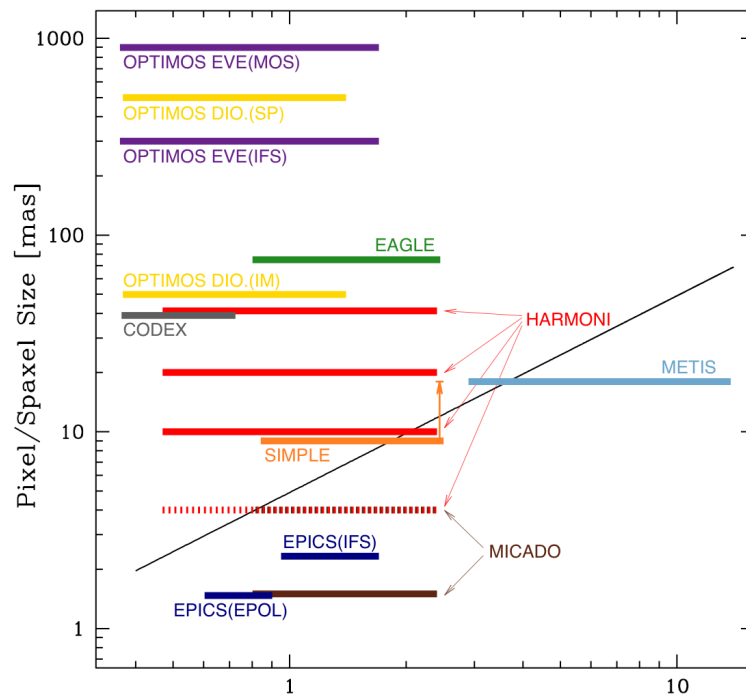

$\lambda[\mu\text{m}]$

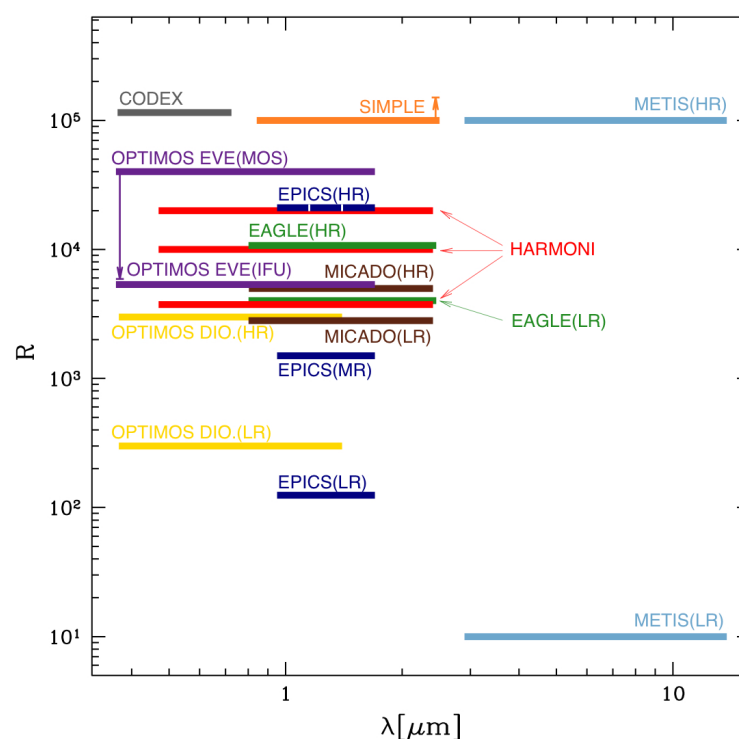

Instrumentation

Current plan:

- Following recommendations by the SWG and STC, 2 first-light instruments have been identified.
- All phase A studies remain in the pool of possible instruments.
- Kick-off of first-light instruments: 2012.
- Kick-off for #3: 2014.
- Thereafter start a new instrument every 2 years.

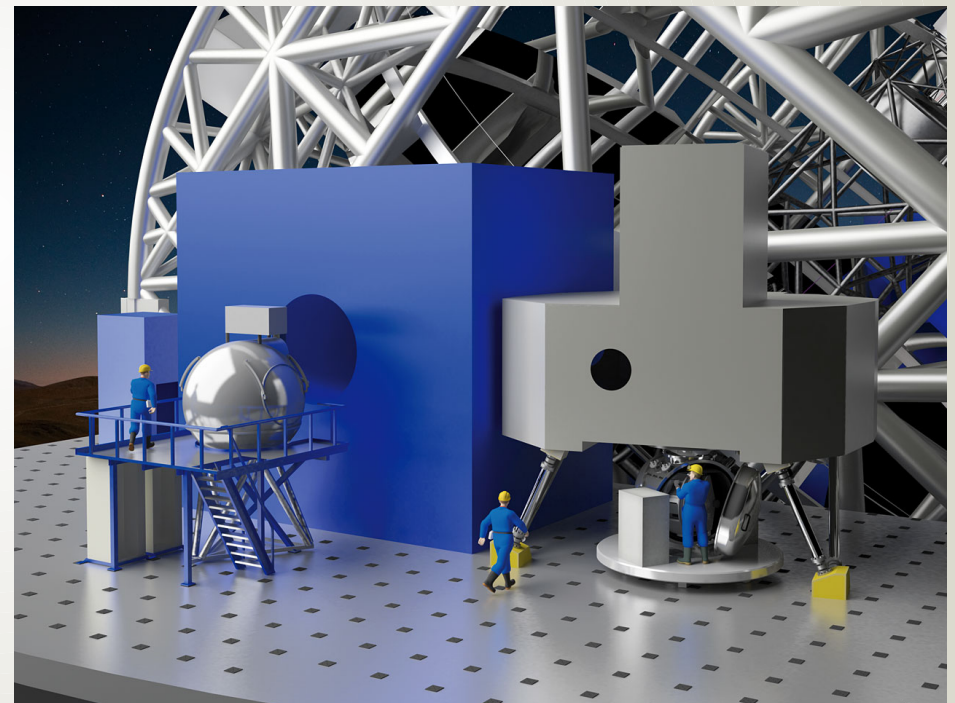

The Site

Following an extensive site testing campaign, involving several sites in Chile, Morocco, the Canary Islands, Argentina, Mexico, ... , ESO Council selected Cerro Armazones as the E-ELT site.

Selection criteria: impact on science, outstanding atmosphere, but also construction and operations logistics (roads, water, electricity, nearby cities, ...).



The Site

Armazones

Paranal



Looking ahead

- Dec 2011: Go-ahead for construction from ESO Council
- And then...

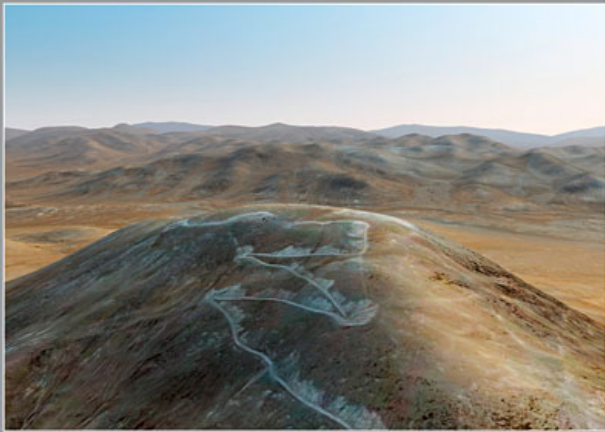

2012



2013

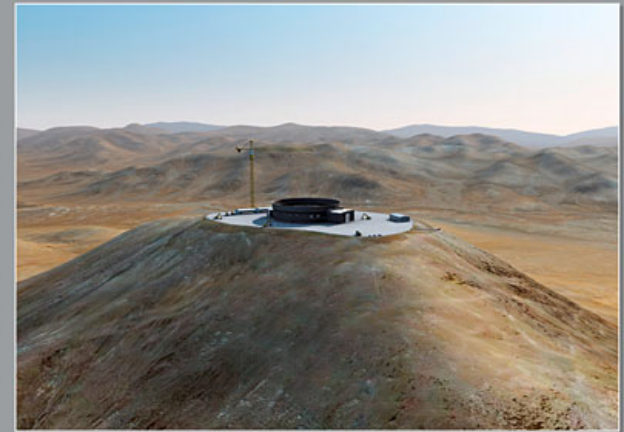

2014

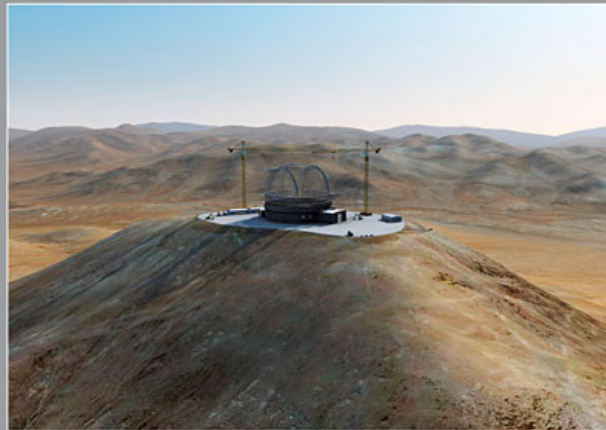

2015



2016

Looking ahead

- Dec 2011: Go-ahead for construction from ESO Council
- And then...

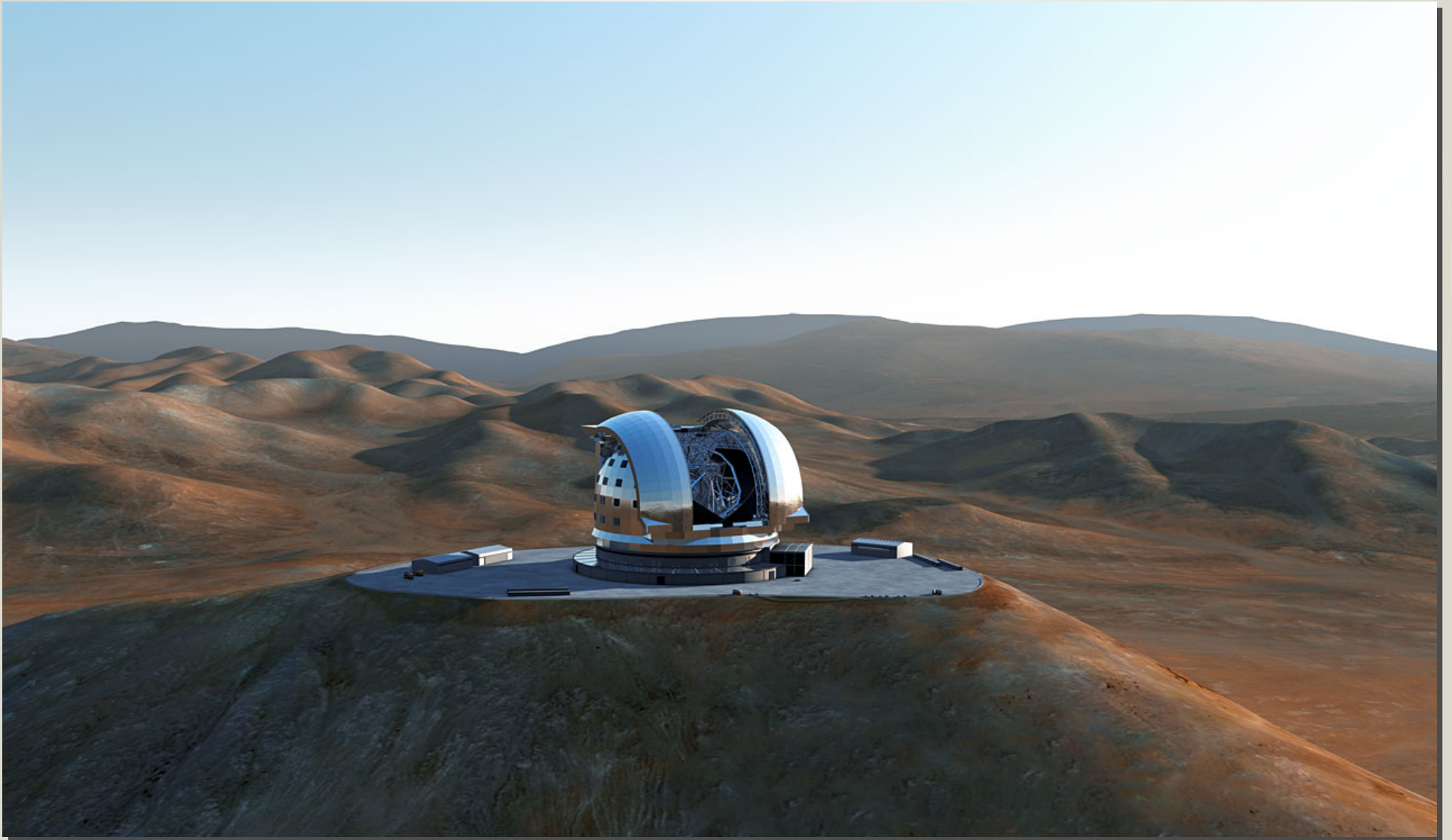

ELT comparison

GMT

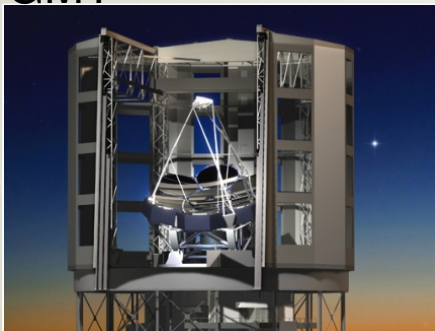

TMT

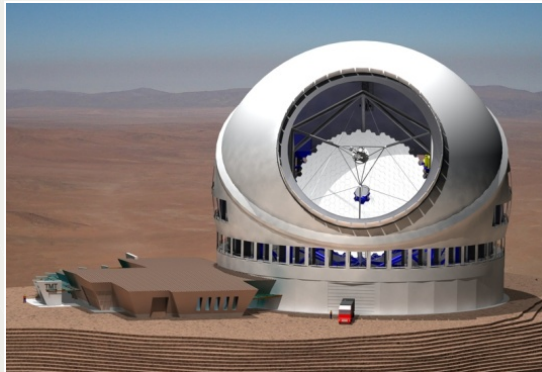

E-ELT

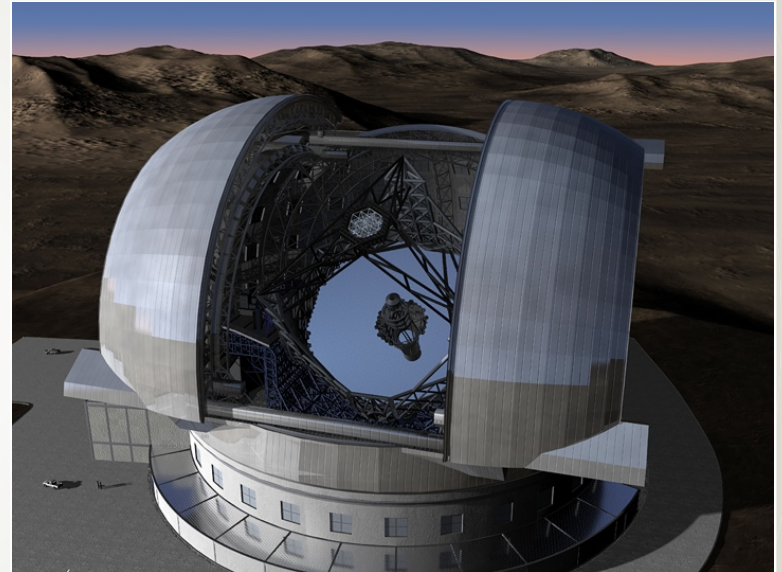

Diameter: 25.4 m
Collecting area: 382 m²
Diff. limit at 1μm: 9.9 mas

30 m
655 m²
8.4 mas

39.3 m
978 m²
6.4 mas

Stellar archaeology

- Present day population of stars in a galaxy = result of all of the star-formation it (or its precursors) experienced + stellar evolution.
- We understand stellar evolution.
- A galaxy's present-day stellar population can be used to deduce the galaxy's major episodes of star-formation and hence to reconstruct its assembly history.
- Stars retain a memory of the ISM out of which they formed. Some stars are very long-lived → handy tracer of star-formation conditions from the earliest times to the present.

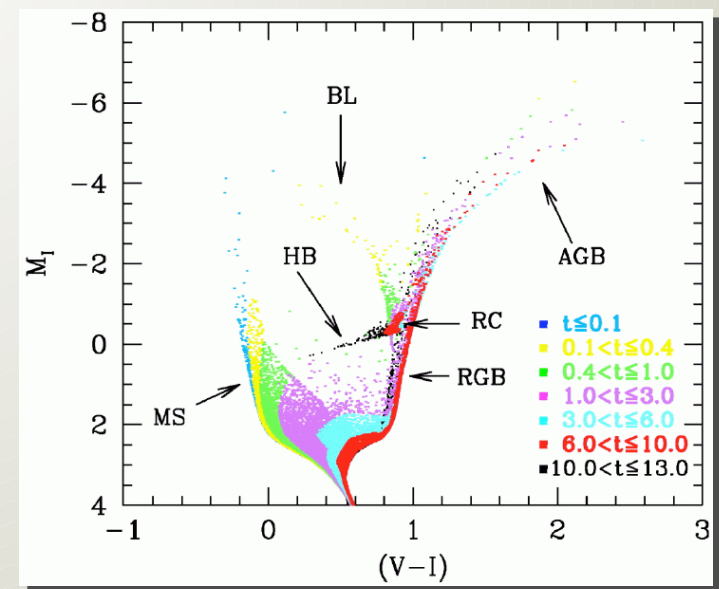
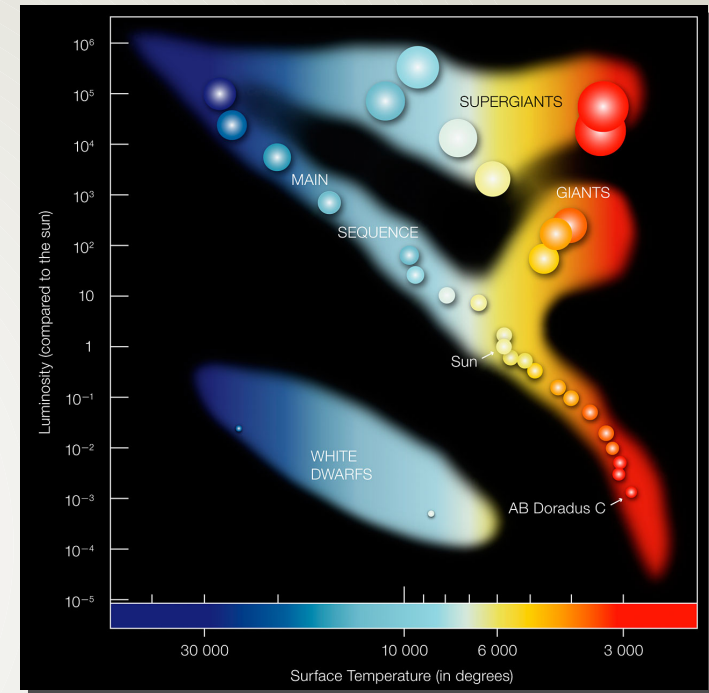

Resolved stellar populations → galaxy evolution

- Want to obtain precise photometry and spectroscopy of resolved stellar pops for a wide range of stellar systems:

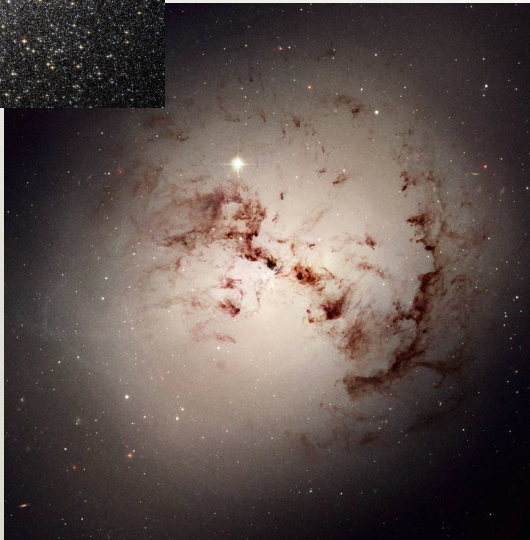
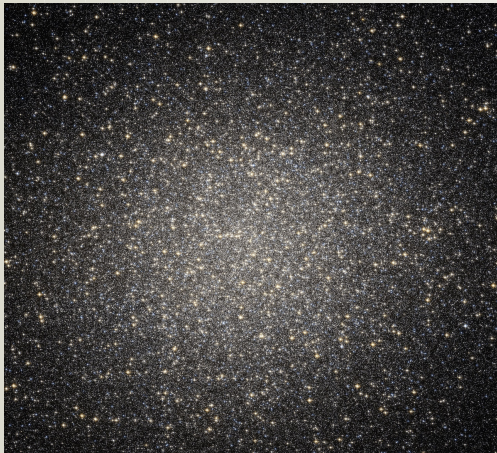

Resolved stellar populations → galaxy evolution

- Want to obtain precise photometry and spectroscopy of resolved stellar pops for a wide range of stellar systems:

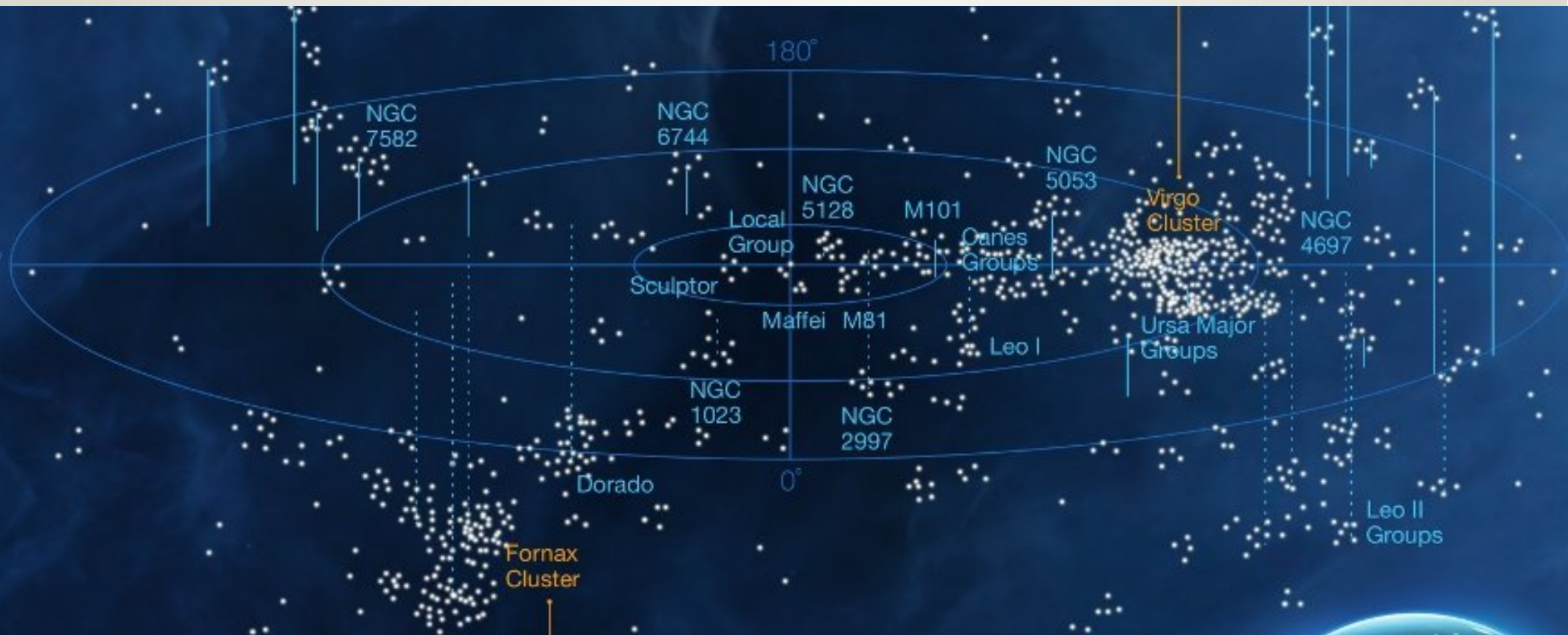



Virgo CMDs with HST

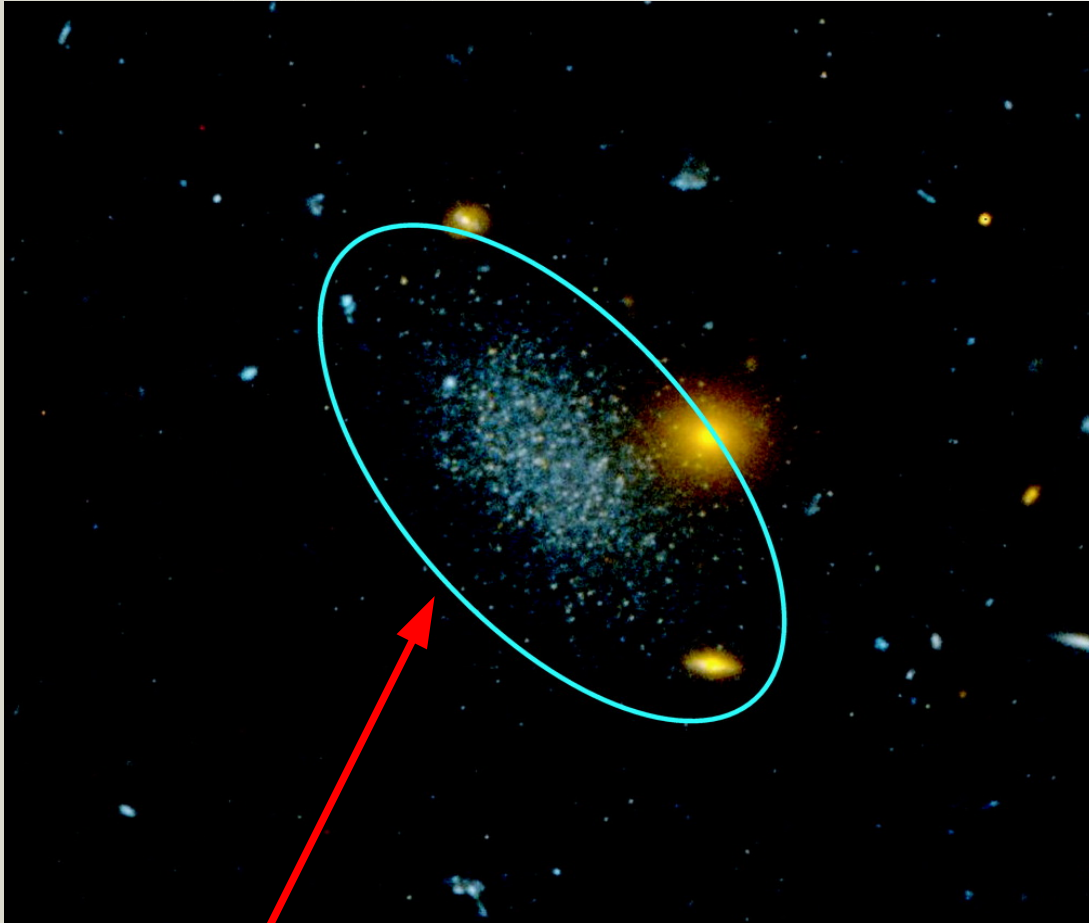

Durrell et al. (2007)

$V \sim 27.5 \text{ mag/arcsec}^2$

Caldwell (2006)

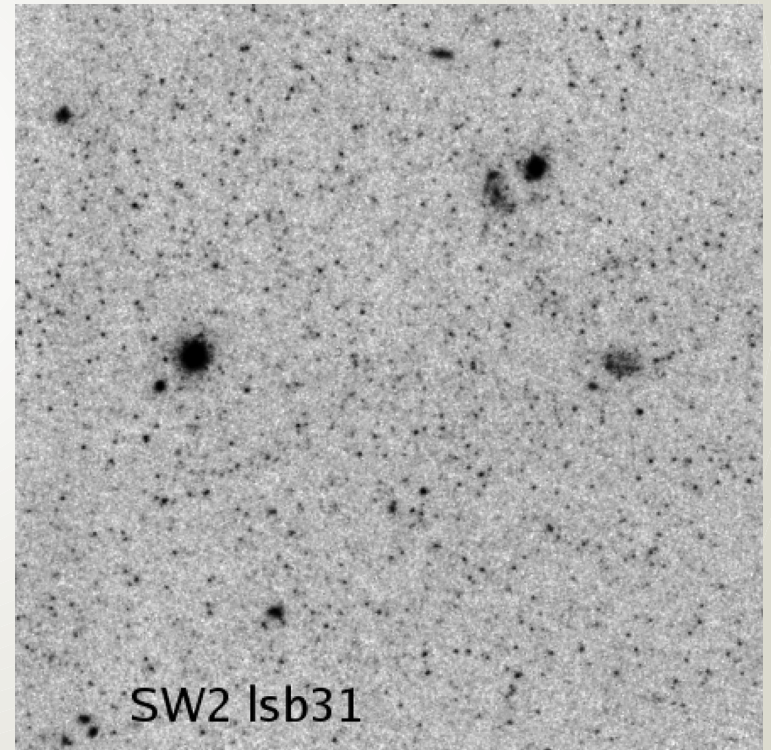

Virgo CMDs with HST

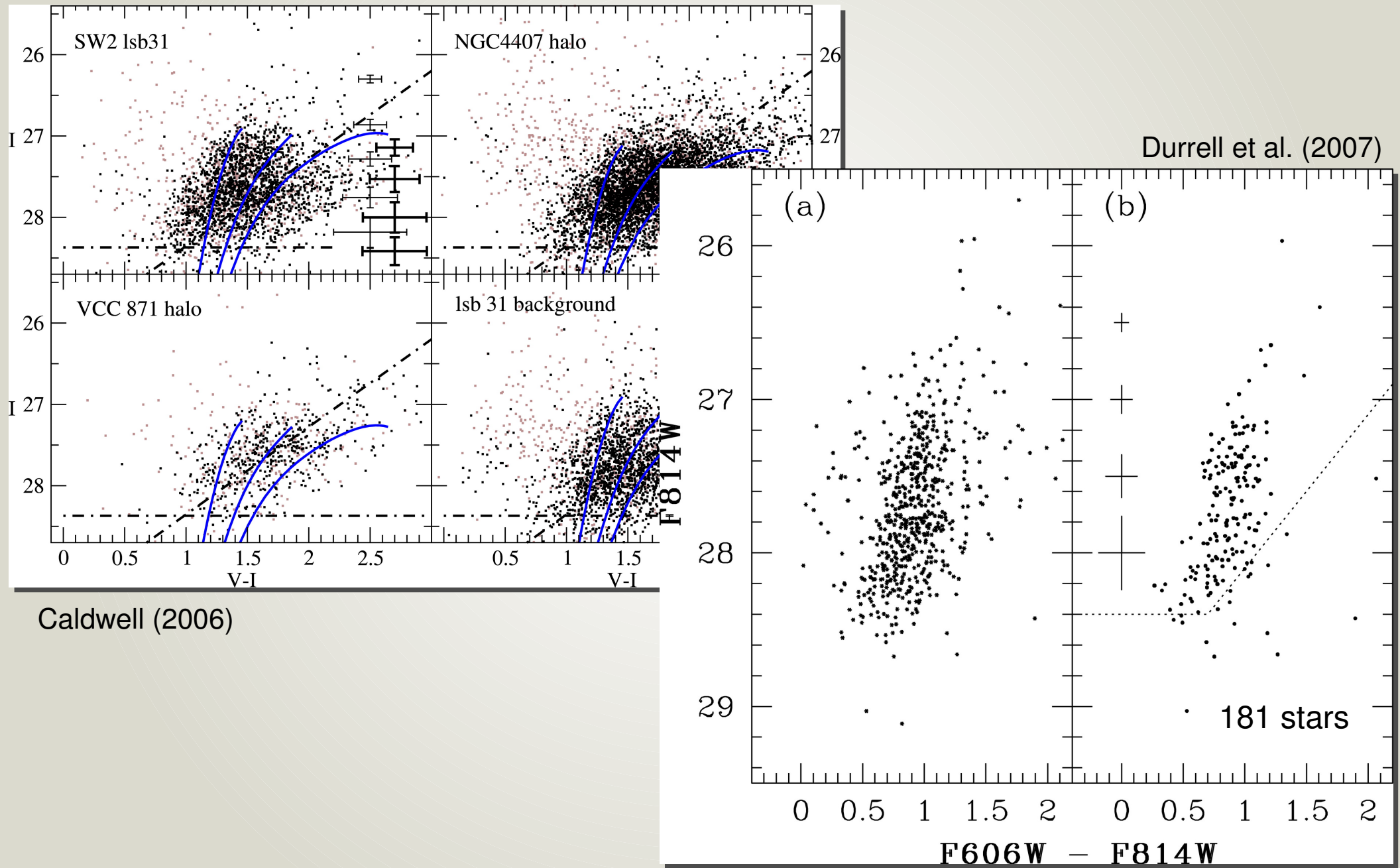

Virgo CMDs with HST

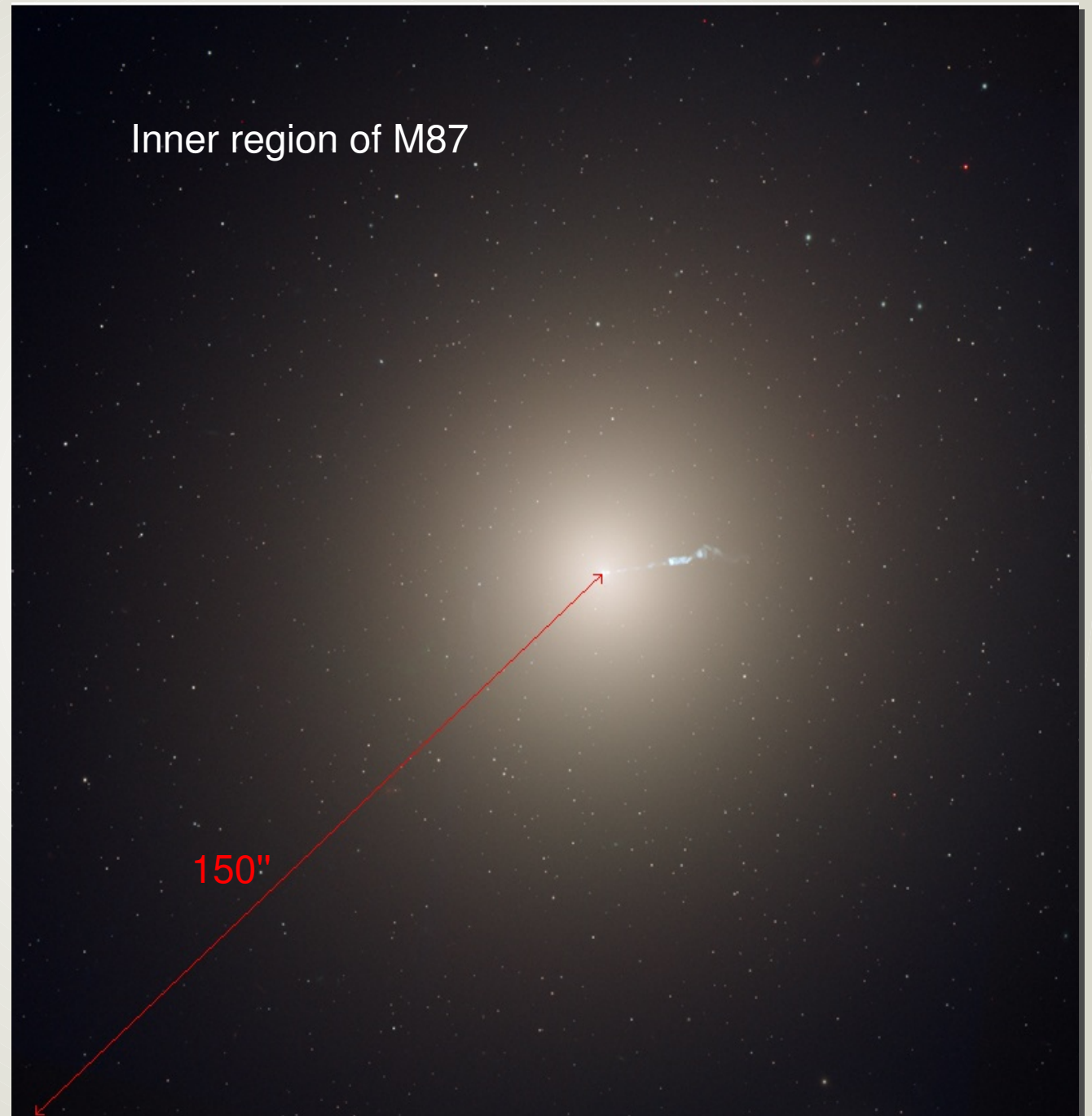

Virgo CMDs with HST

Bird et al. (2010):

- HST/ACS
- 12.5" x 12.5"
- F814W
- ~20 hours
- 0.025"/pixel

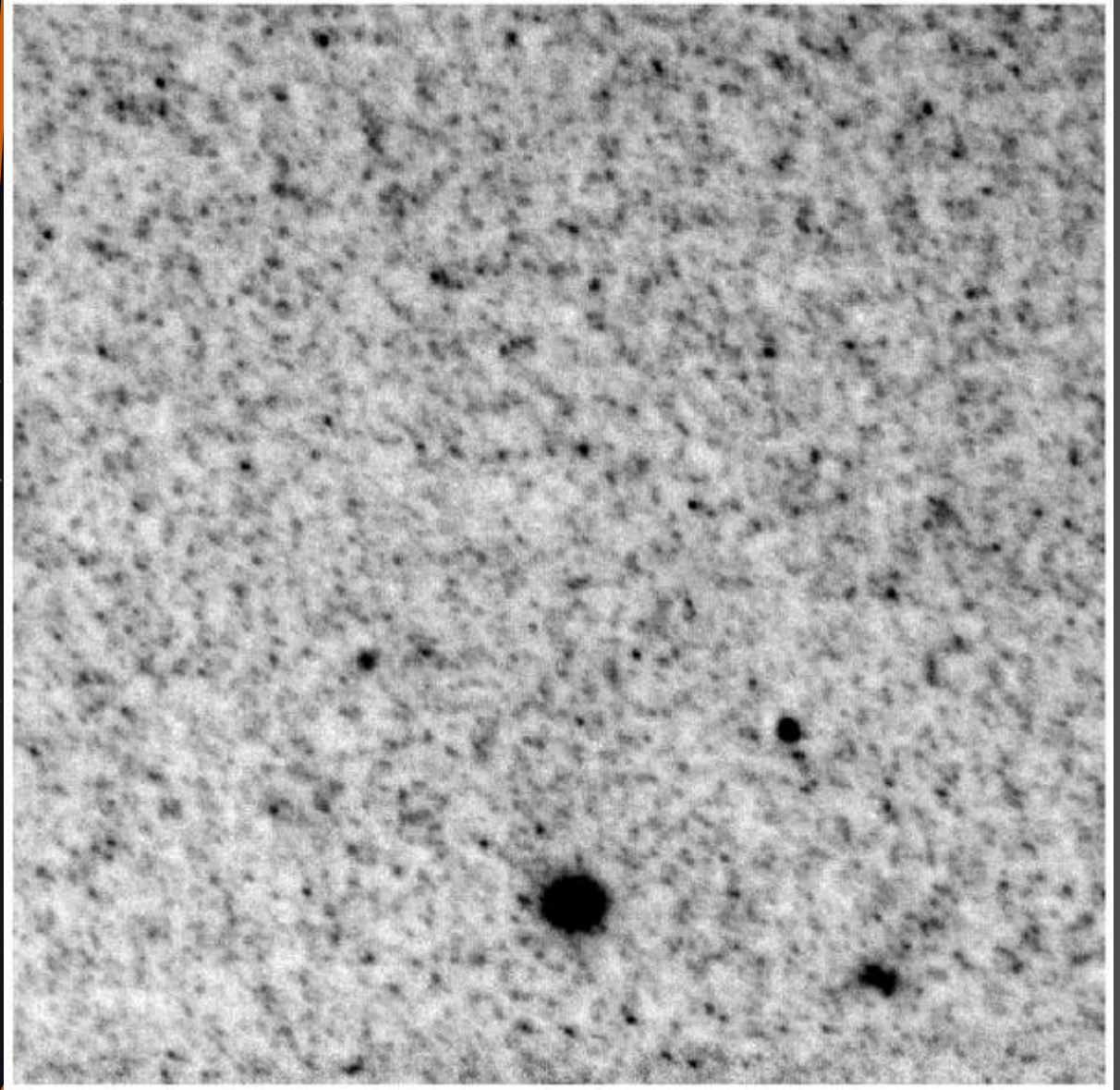

Virgo CMDs with HST

Bird et al. (2010):

- HST/ACS
- F814W
- ~20 hours
- 0.025"/pixel

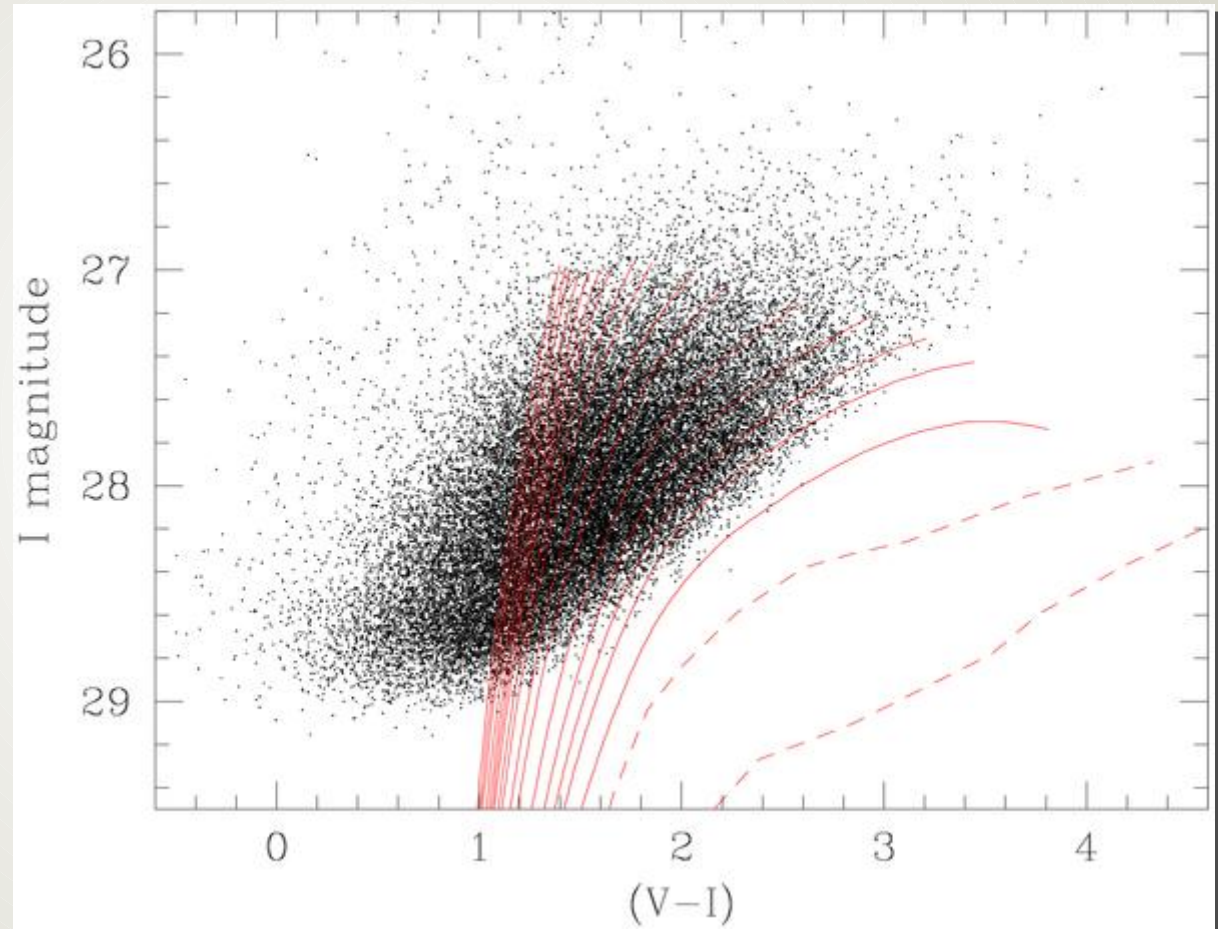

Virgo CMDs with HST

Bird et al. (2010):

- HST/ACS
- 3" x 3"
- F814W
- ~20 hours
- 0.025"/pixel

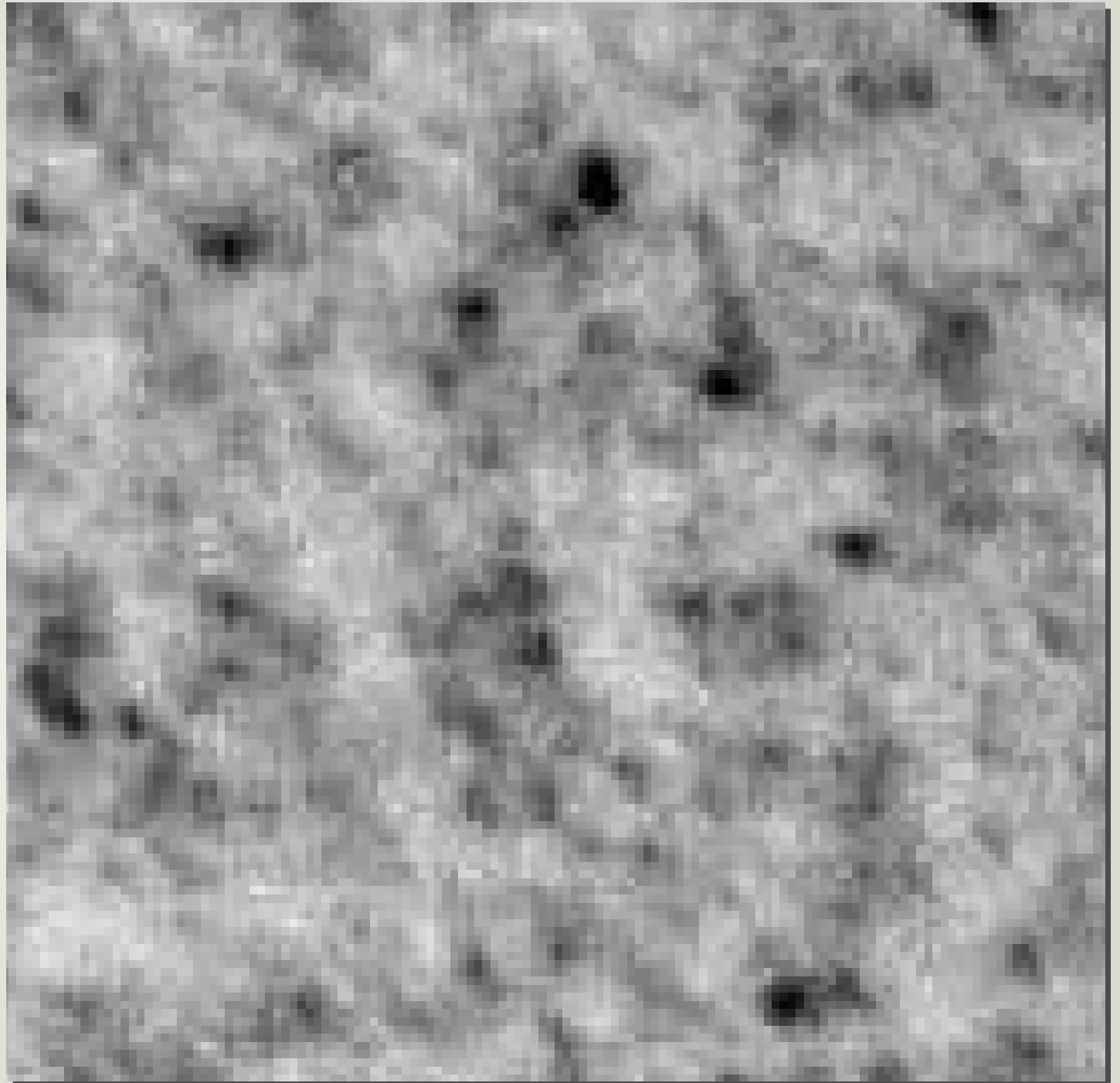

Simulation:

I-band

10 hours

3" x 3"

DM = 31.2

$\mu = 23 \text{ mag/arcsec}^2$

TinyTim model of

HST ACS F814W

PSF from Rhodes et

al. (2007),

no drizzling

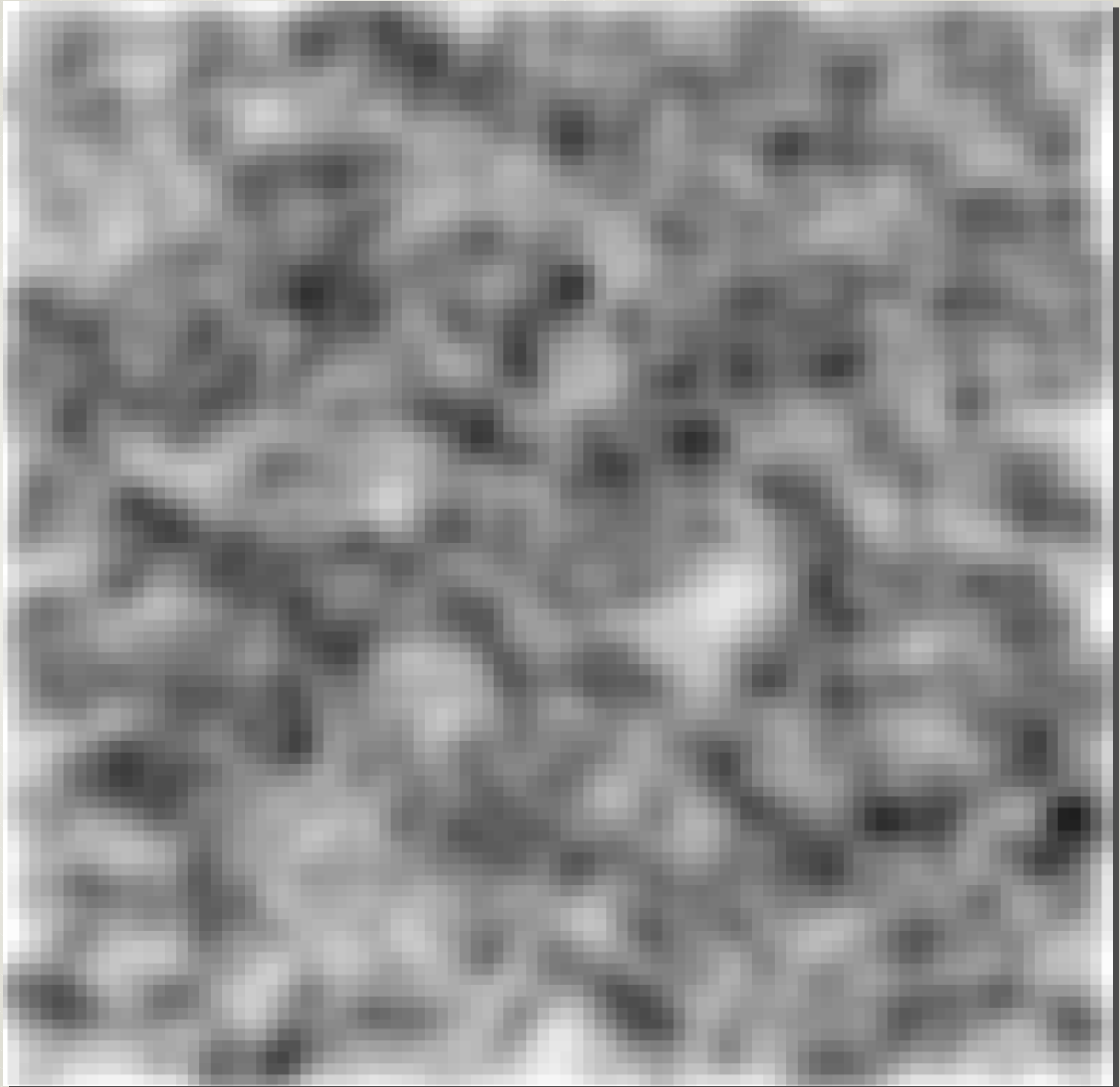

Simulation:

I-band

10 hours

3" x 3"

DM = 31.2

$\mu = 23 \text{ mag/arcsec}^2$

E-ELT I-band PSF

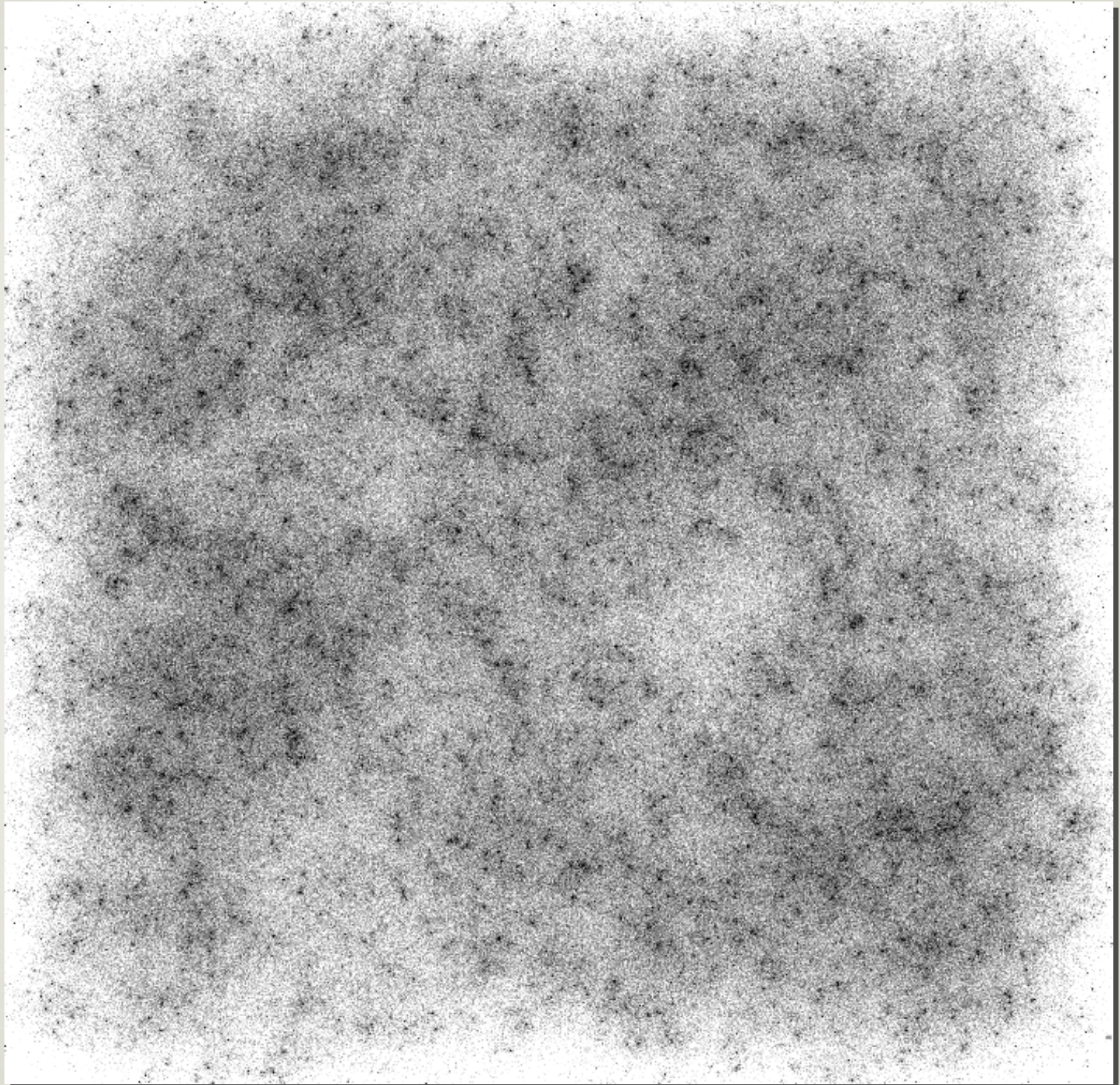

Simulation:

I-band

10 hours

3" x 3"

DM = 31.2

$\mu = 23 \text{ mag/arcsec}^2$

E-ELT I-band PSF

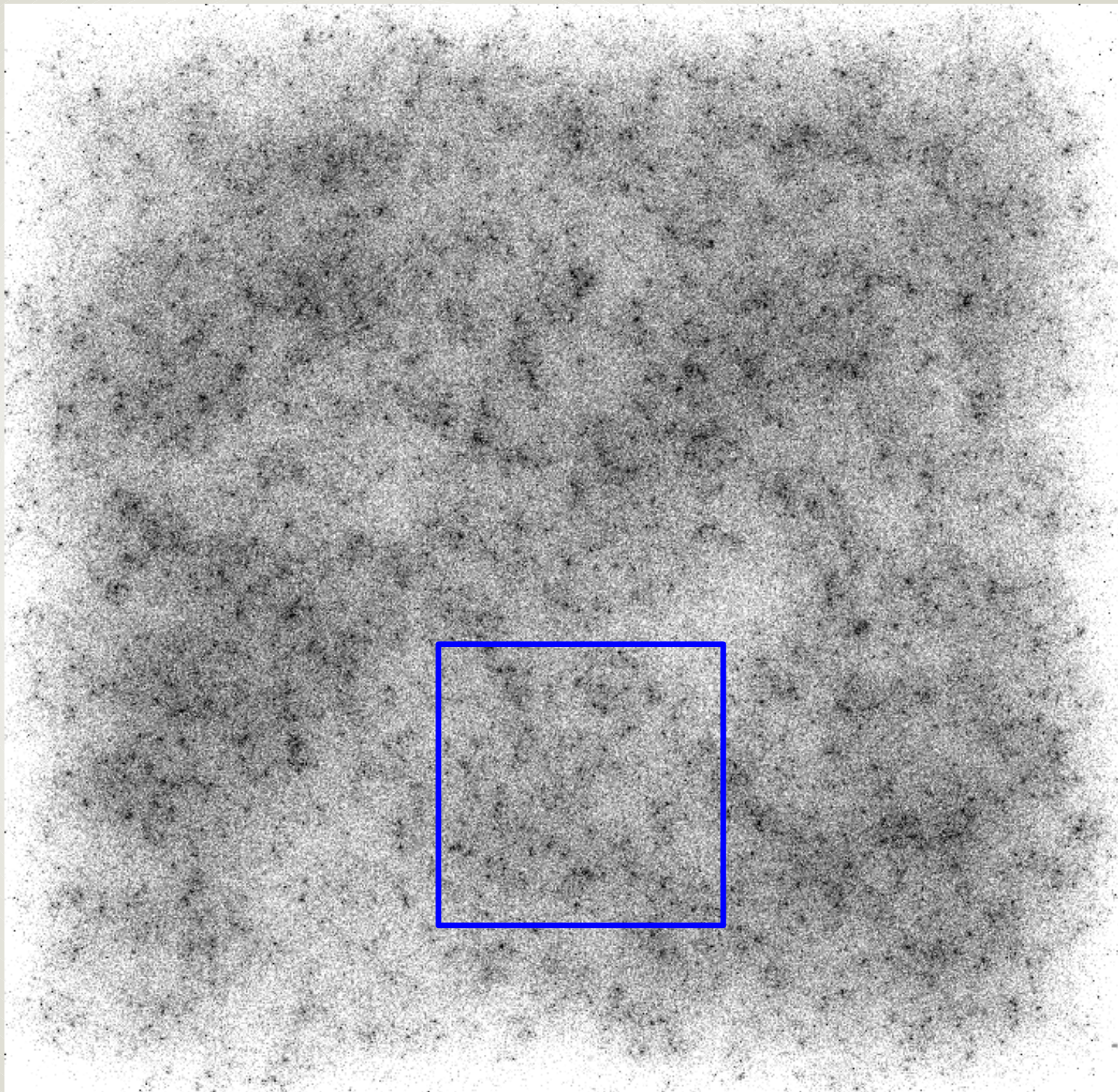

Simulation:

I-band

10 hours

0.8" x 0.8"

DM = 31.2

$\mu = 23 \text{ mag/arcsec}^2$

E-ELT I-band PSF

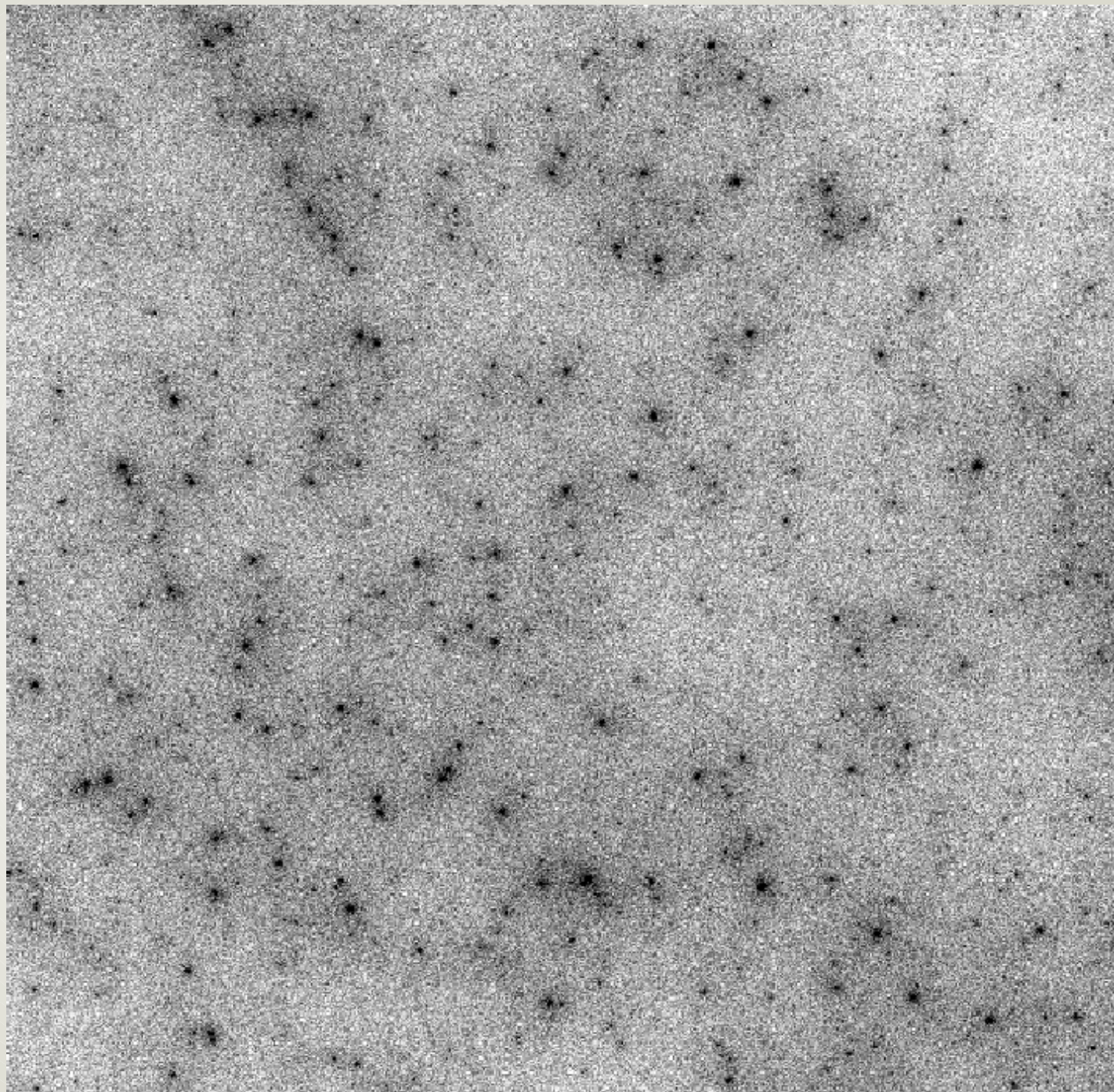

Resolved stellar populations and the E-ELT

- Very prominent science case for the E-ELT!

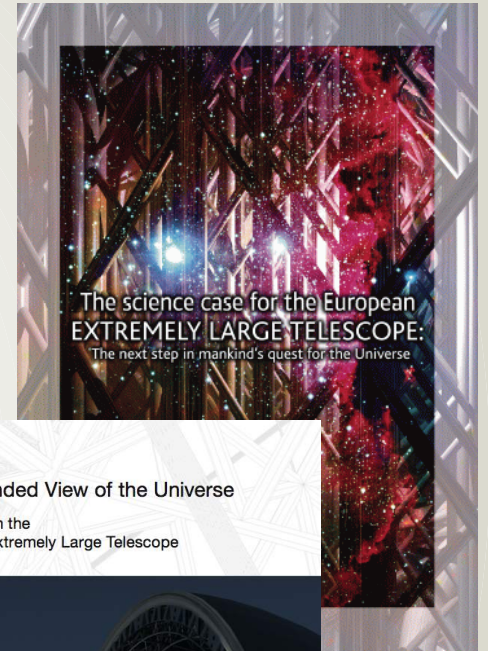

An Expanded View of the Universe

Science with the
European Extremely Large Telescope



Resolved stellar populations and the E-ELT

- Very prominent science case for the E-ELT!

Quick look: what can we expect?

Isochrones:

- $[Fe/H] = -1.8, -1, -0.6$
- Age = 5, 9, 13 Gyr

Mag limits:

- $T_{\text{exp}} = 10$ hours
- S/N = 20
- No crowding

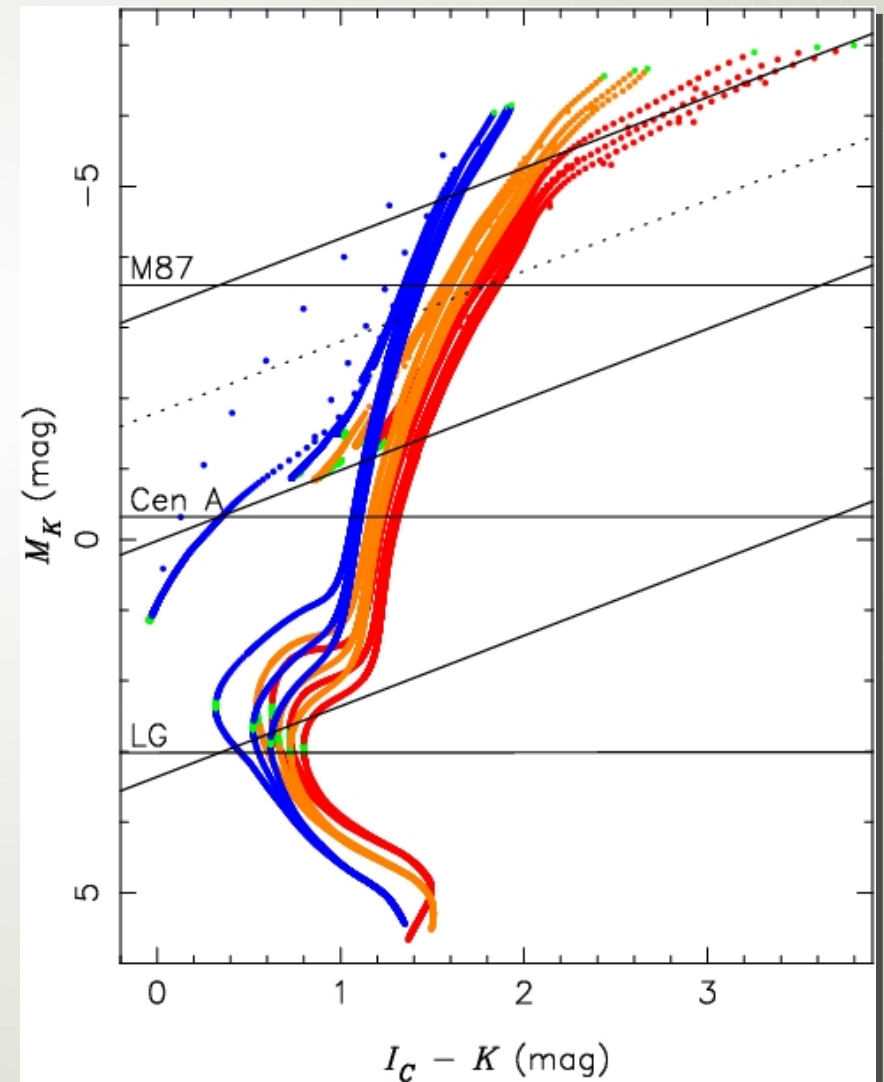

Resolved stellar populations and the E-ELT

- Very prominent science case for the E-ELT!
- Selected by the E-ELT Science Working Group for study by the Design Reference Mission (DRM).
- DRM = hands-on exploration of a few science cases through the analysis of simulated E-ELT data. Purpose:
 - quantitative assessment of what the E-ELT will be able to achieve
 - assist in trade-off decisions
 - support development of Science Case
- See <http://www.eso.org/sci/facilities/eelt/science/drm/>
- Two RSP cases considered in the DRM:
 - Imaging: CMDs of elliptical galaxies
 - Spectroscopy (G. Battaglia)
 - SWG member responsible: Eline Tolstoy

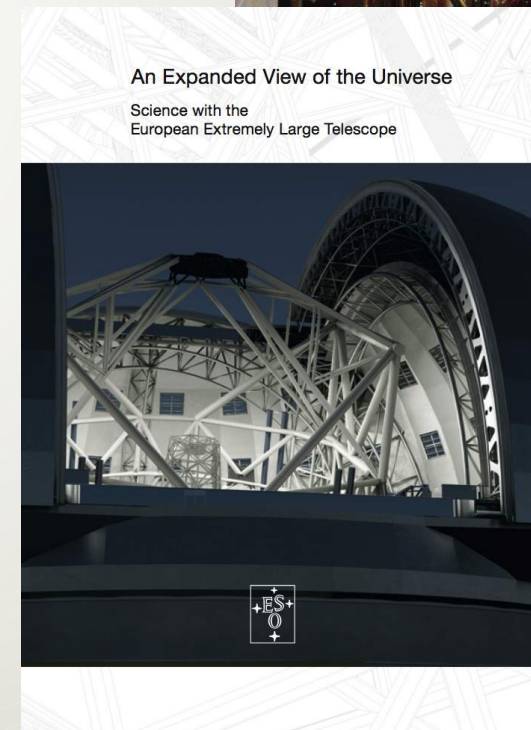
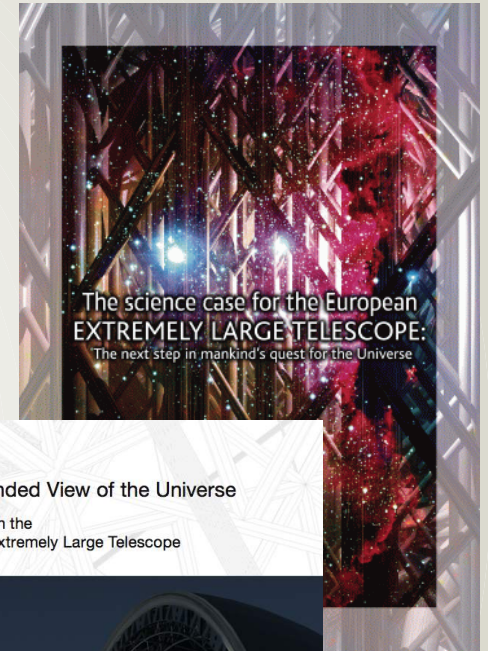

E-ELT and CMDs: specific questions

- What is the limiting magnitude down to which accurate photometry of a galaxy's RSP is possible as a function of:
 - the galaxy's distance
 - the surface brightness within the galaxy (equivalent to galactocentric radius for a given profile)
 - the observing band (what is the best combination of bands to use?)
 - the performance of the AO
 - the assumed stellar population
- What is the effect of PSF uncertainties?
- Method: brute-force Monte Carlo simulations

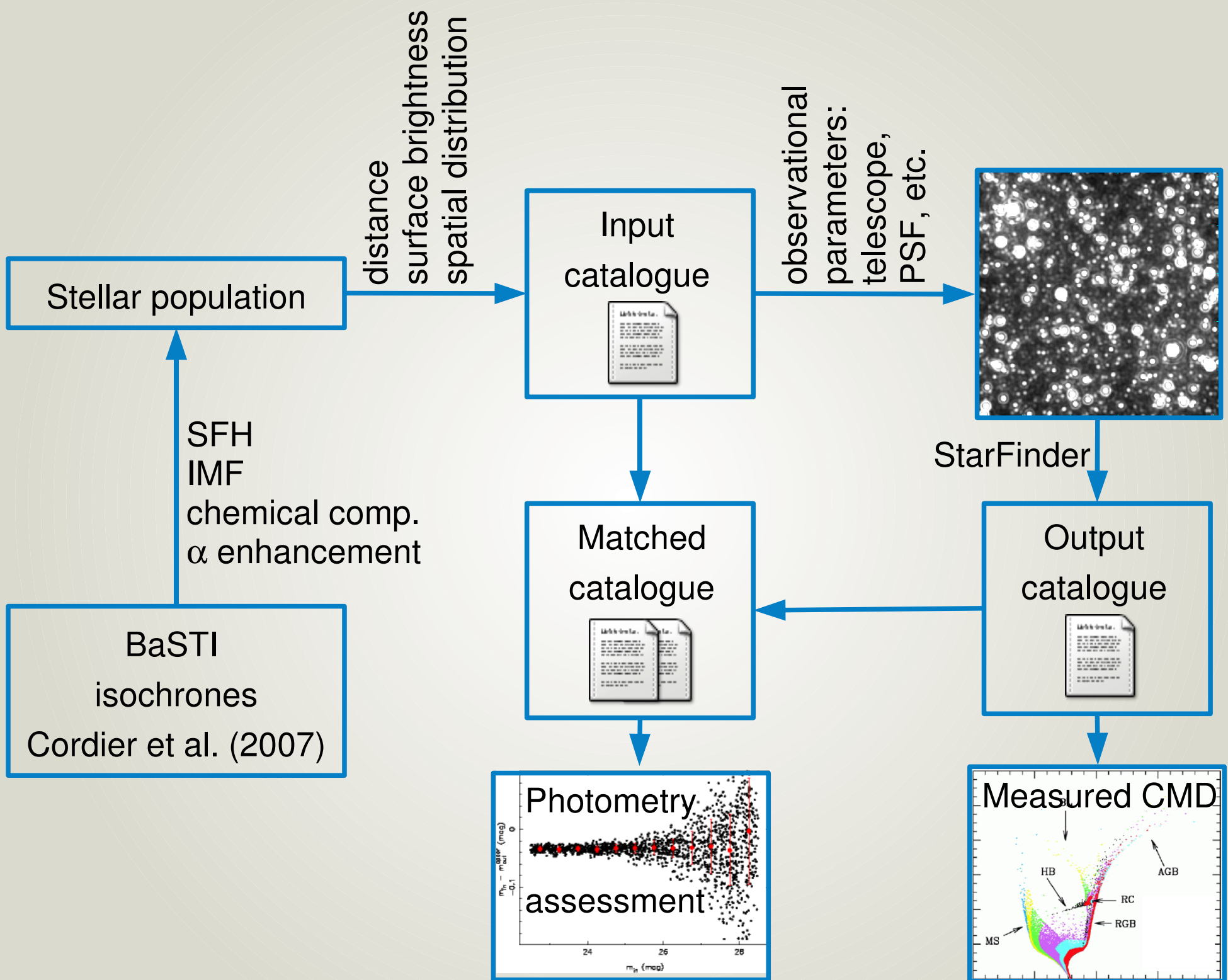

Simulation parameters

- Stellar population:
 - SFH: constant from 14 – 12 Gyr ago
 - IMF: Salpeter, i.e. $\alpha = -2.35$
 - $[\text{Fe}/\text{H}] = -1.8, -1, -0.6$
- Galaxy data:

	NGC 205 (LG)	Cen A (NGC 5128)	M87
DM	24.58	27.92	31.2
kpc/arcsec	0.00396	0.0186	0.084
kpc/arcmin	0.238	1.116	5.055
Profile	Exponential	de Vaucouleurs	de Vaucouleurs
Scale or effective radius (arcsec)	$h = 102$	$R_e = 330$	$R_e = 105$
Central or effective SB (mag arcsec^{-2})	$\mu_0 = 20.4$	$\mu_e = 22.15$	$\mu_e = 20.58$

- Telescope: 42 m!
- PSFs: ESO's in-house simulations of LTAO PSFs.

LTAO PSFs

- Because ESO's PSF simulations are computationally so expensive only short integration PSFs (4s) have been simulated.
- Problem: speckle noise.
- Also: the PSF images have to be very large in order to sample a good contrast range.
- Solution: represent PSFs with a 'small' number of analytic components.

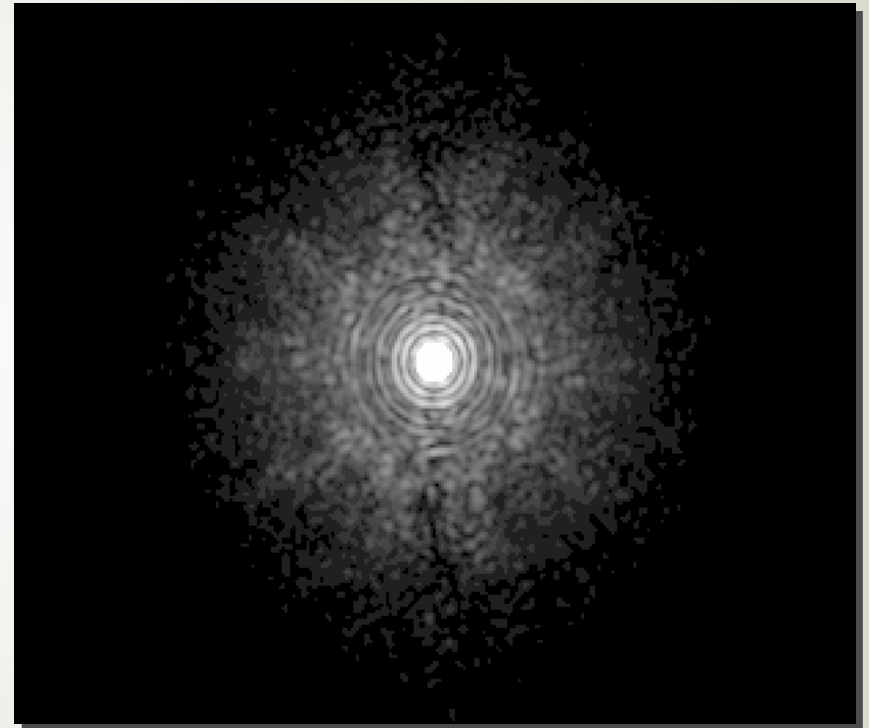

PSF fitting

I

J

H

K

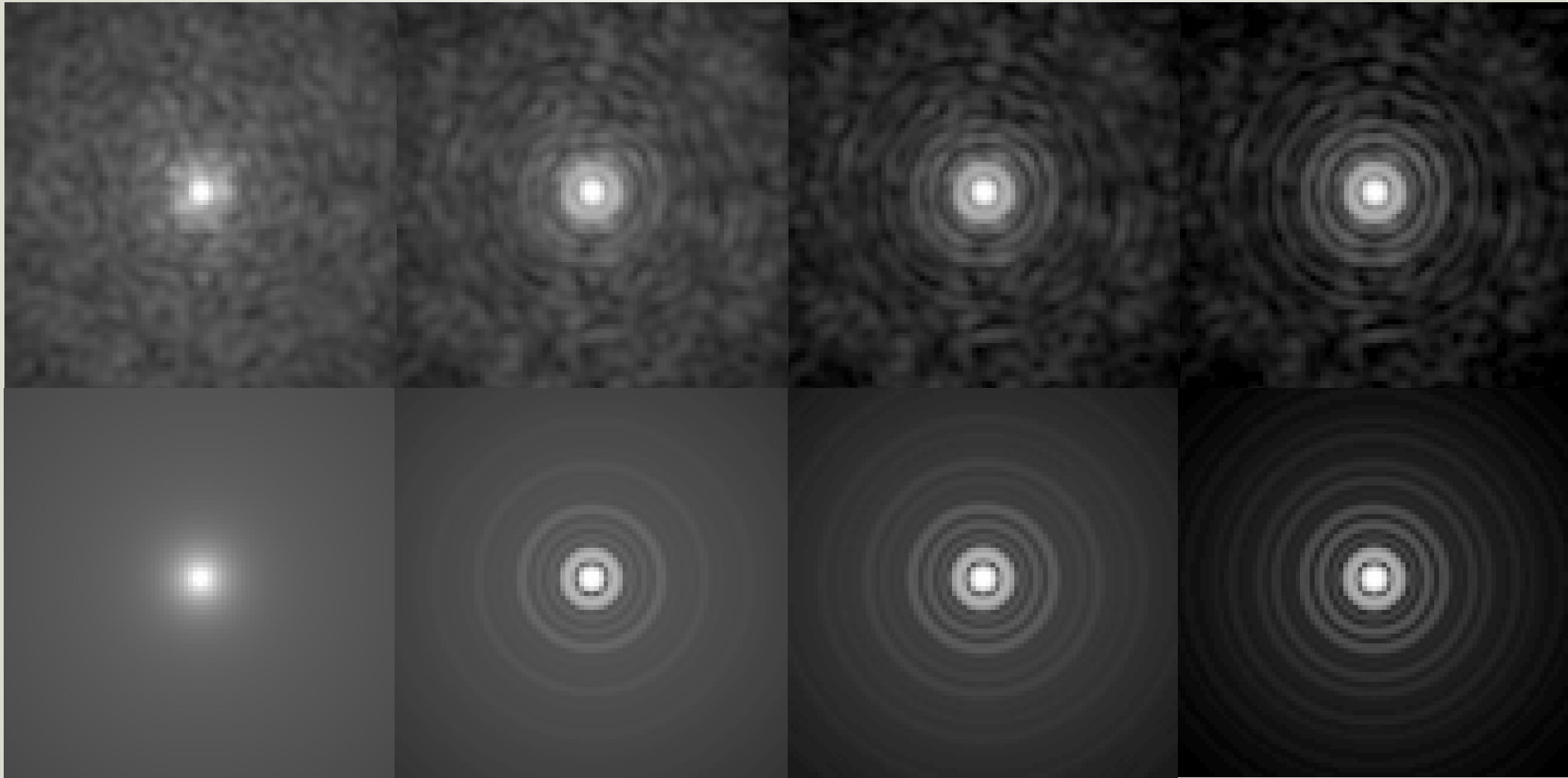

PSF fitting

H

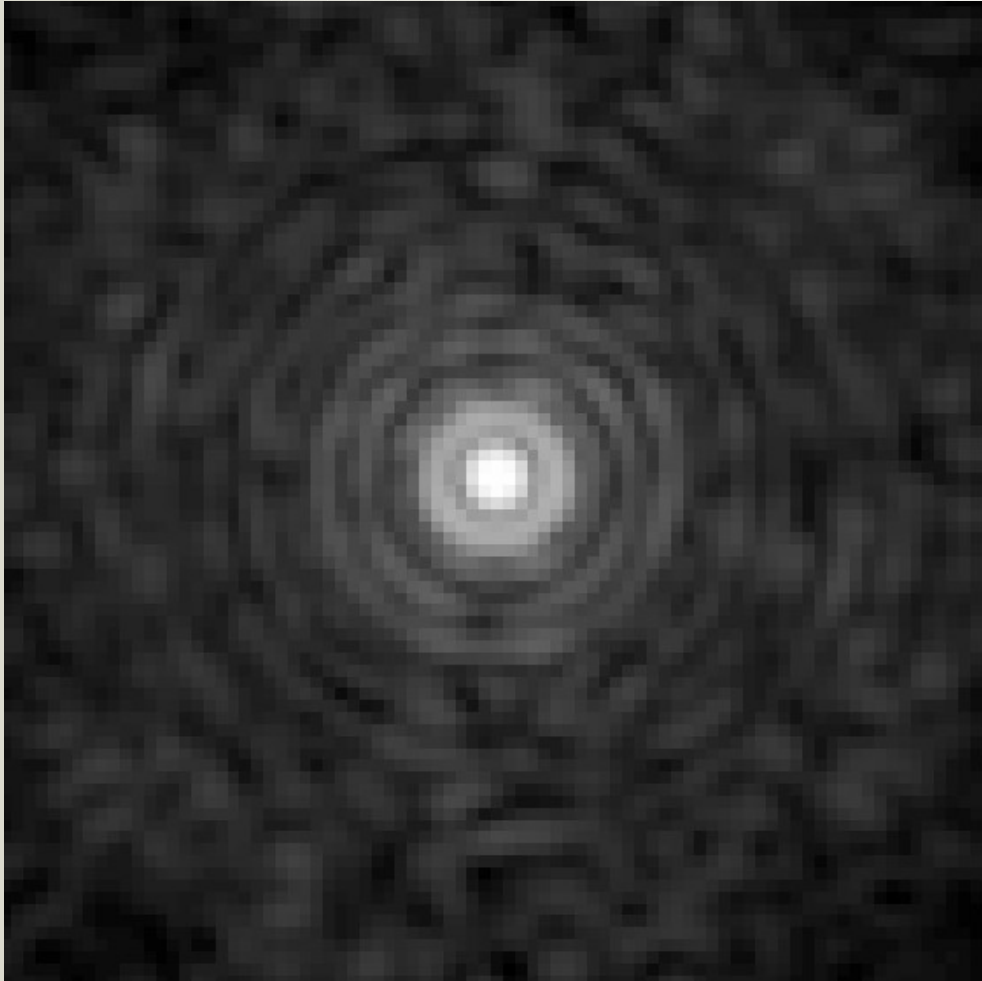

K

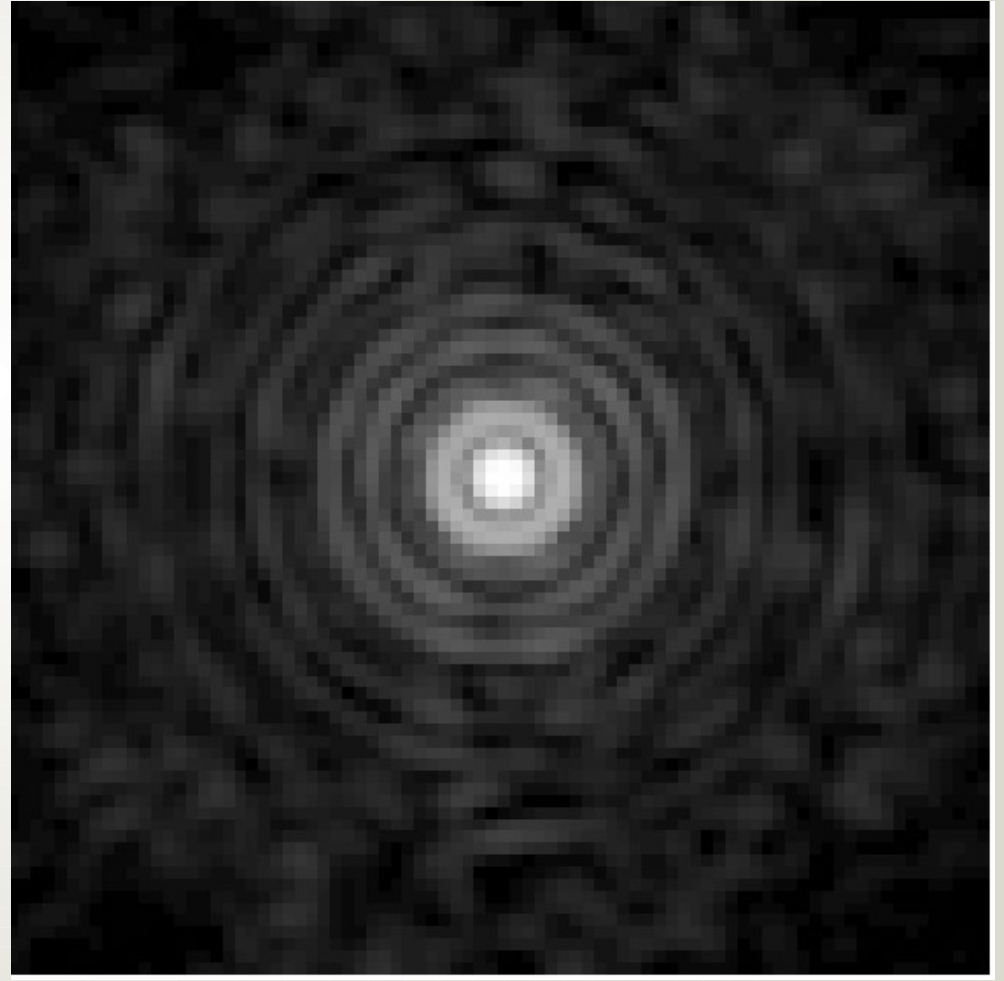

PSF fitting

H

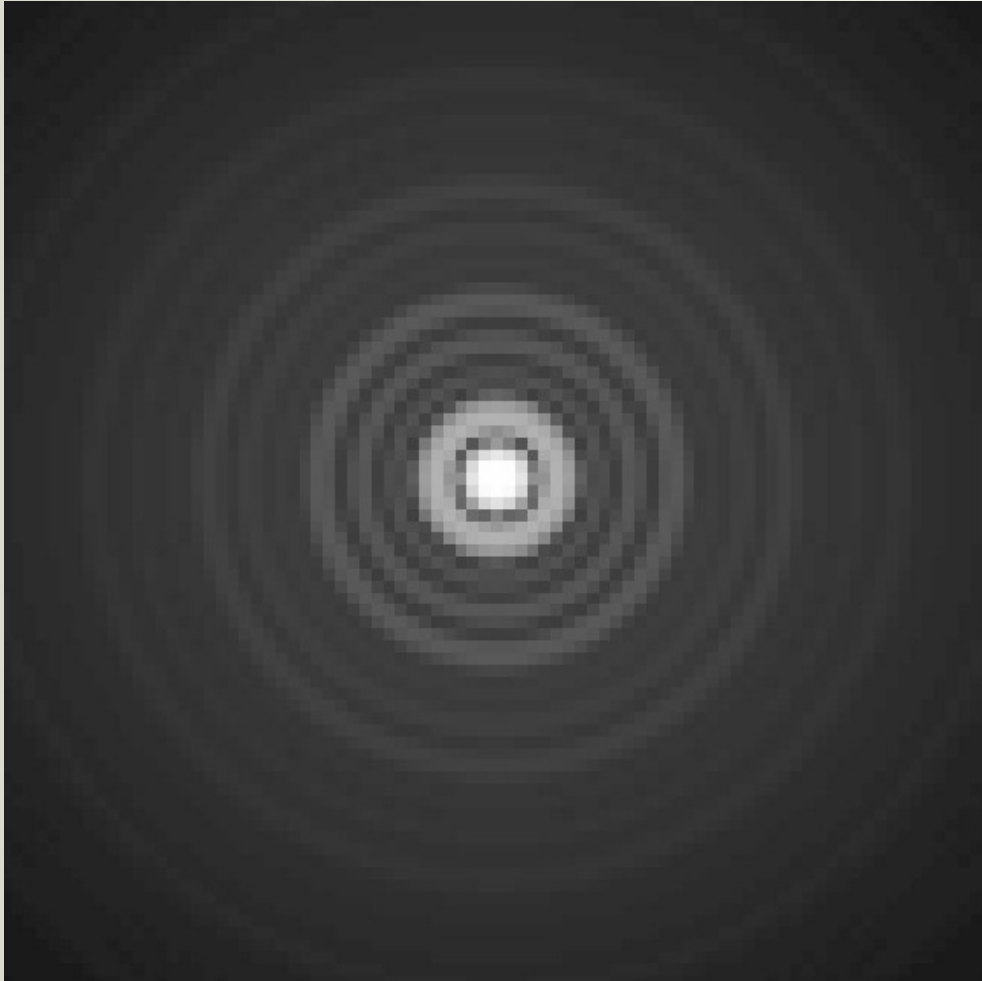

K

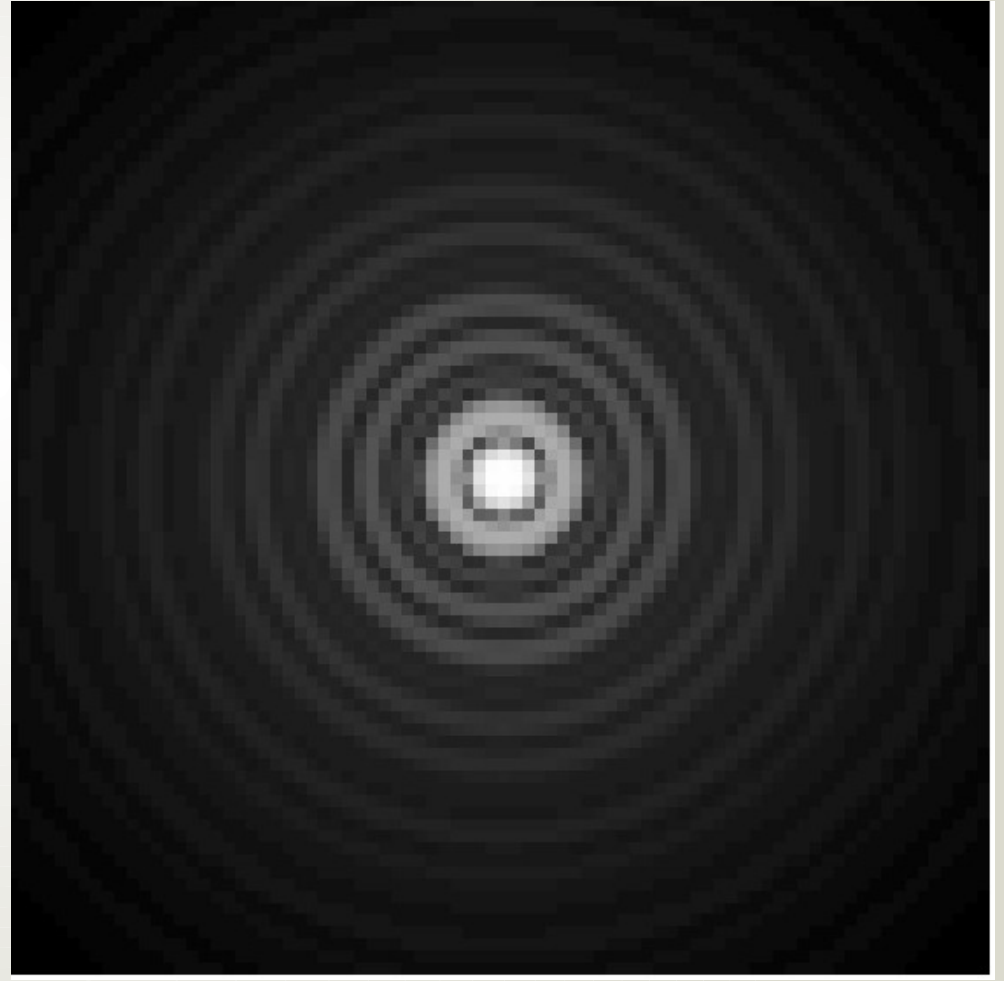

Simple test case: no crowding

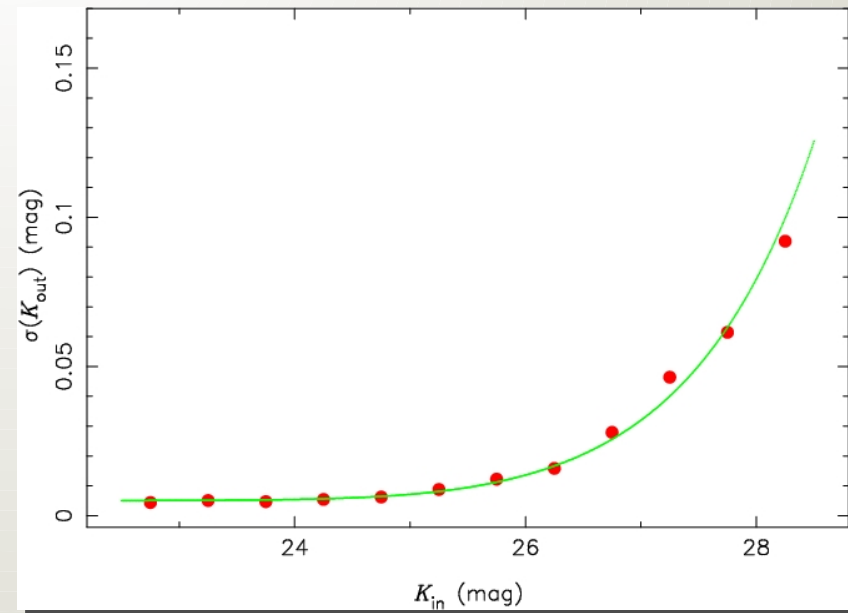
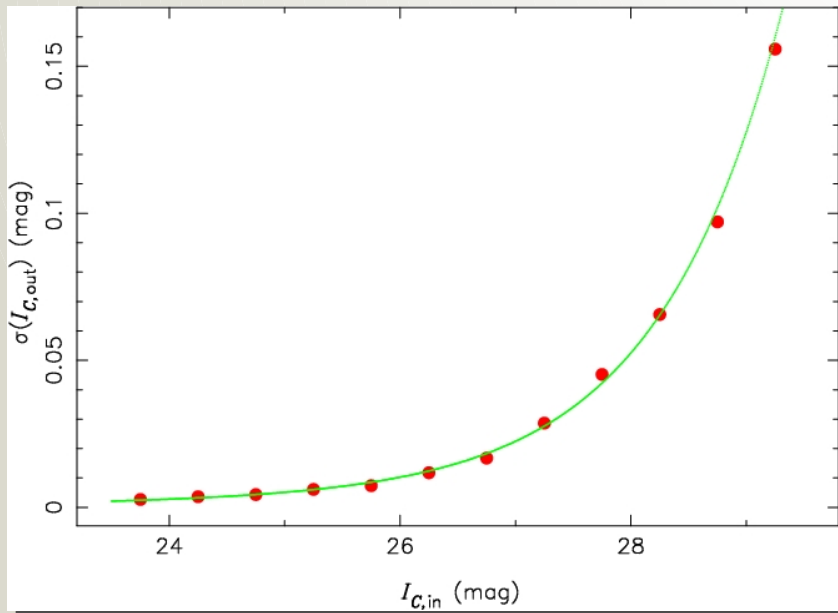
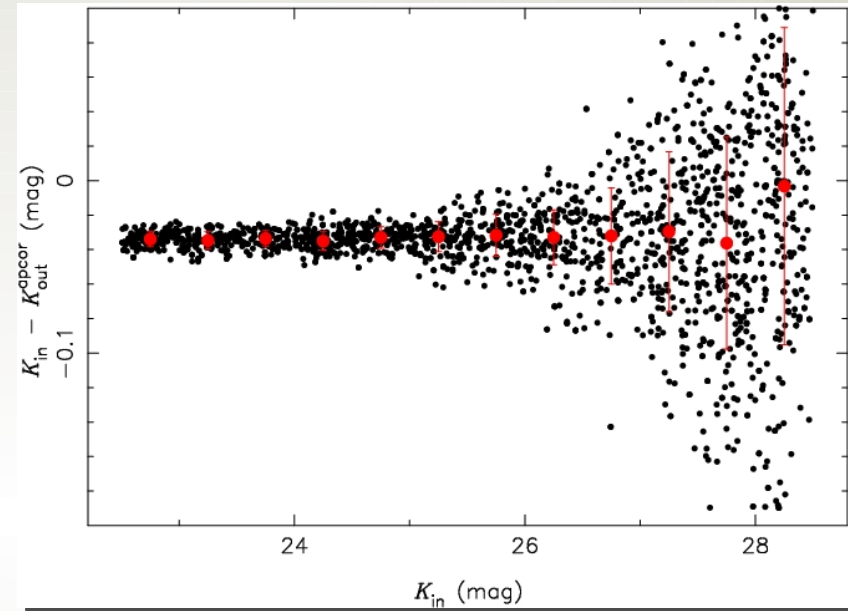
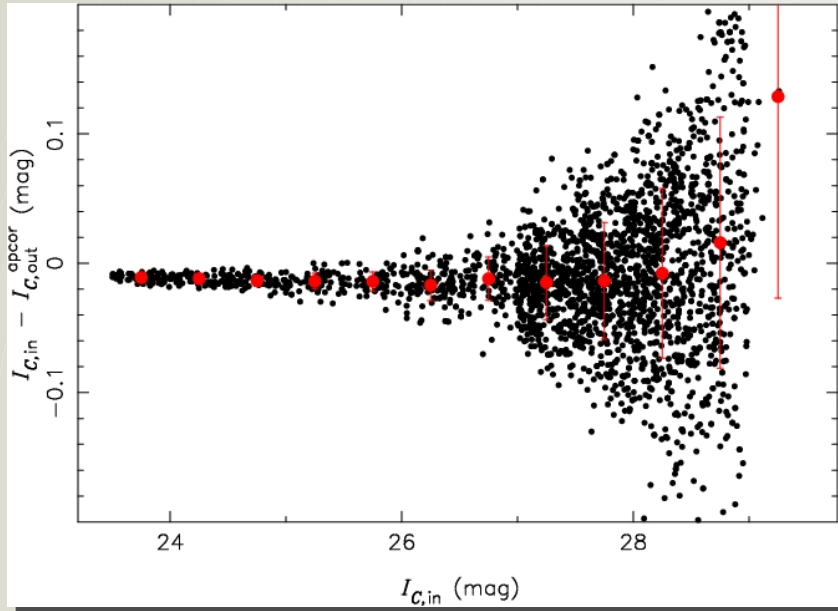

Full result: M87

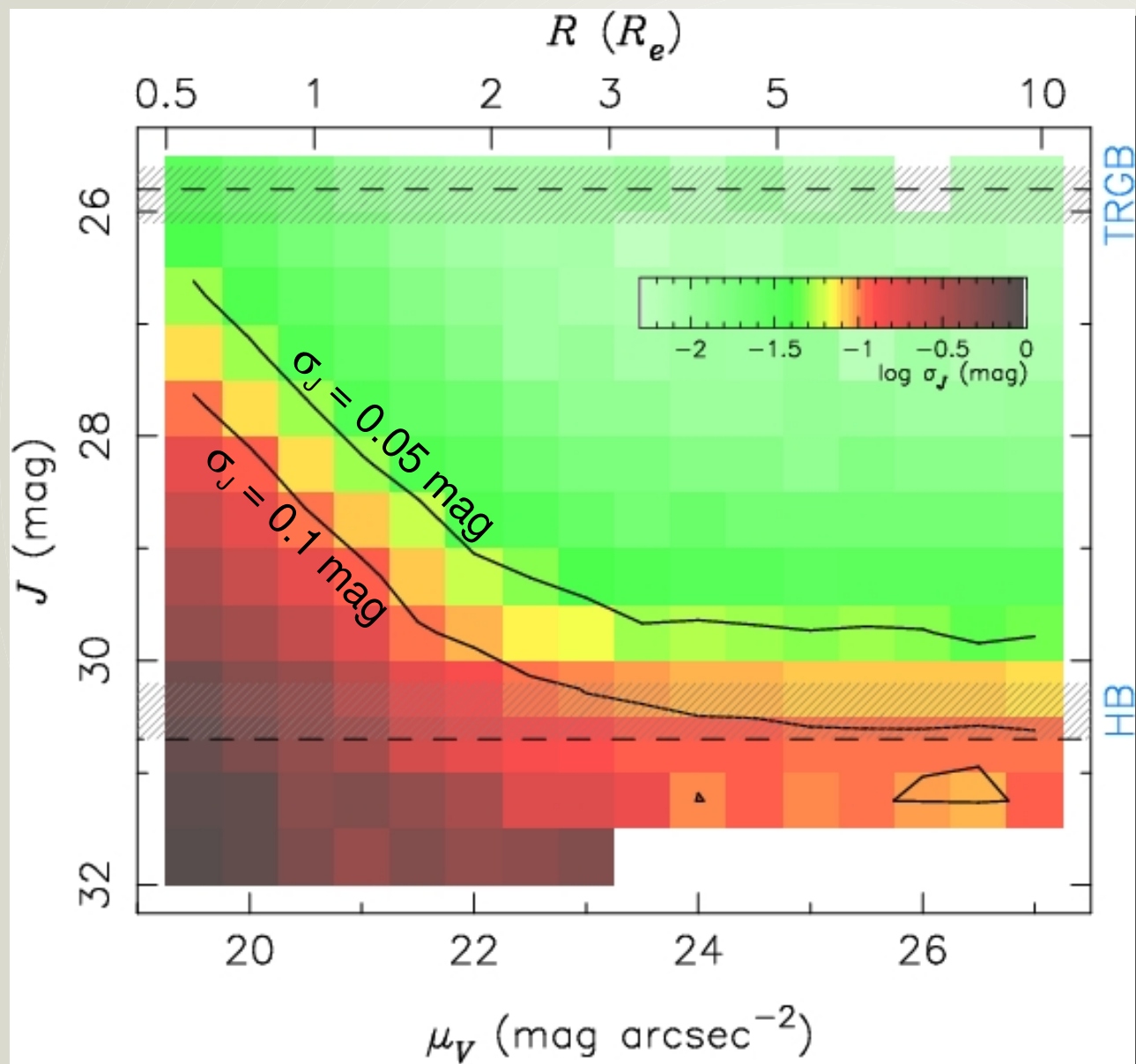

Full result: M87

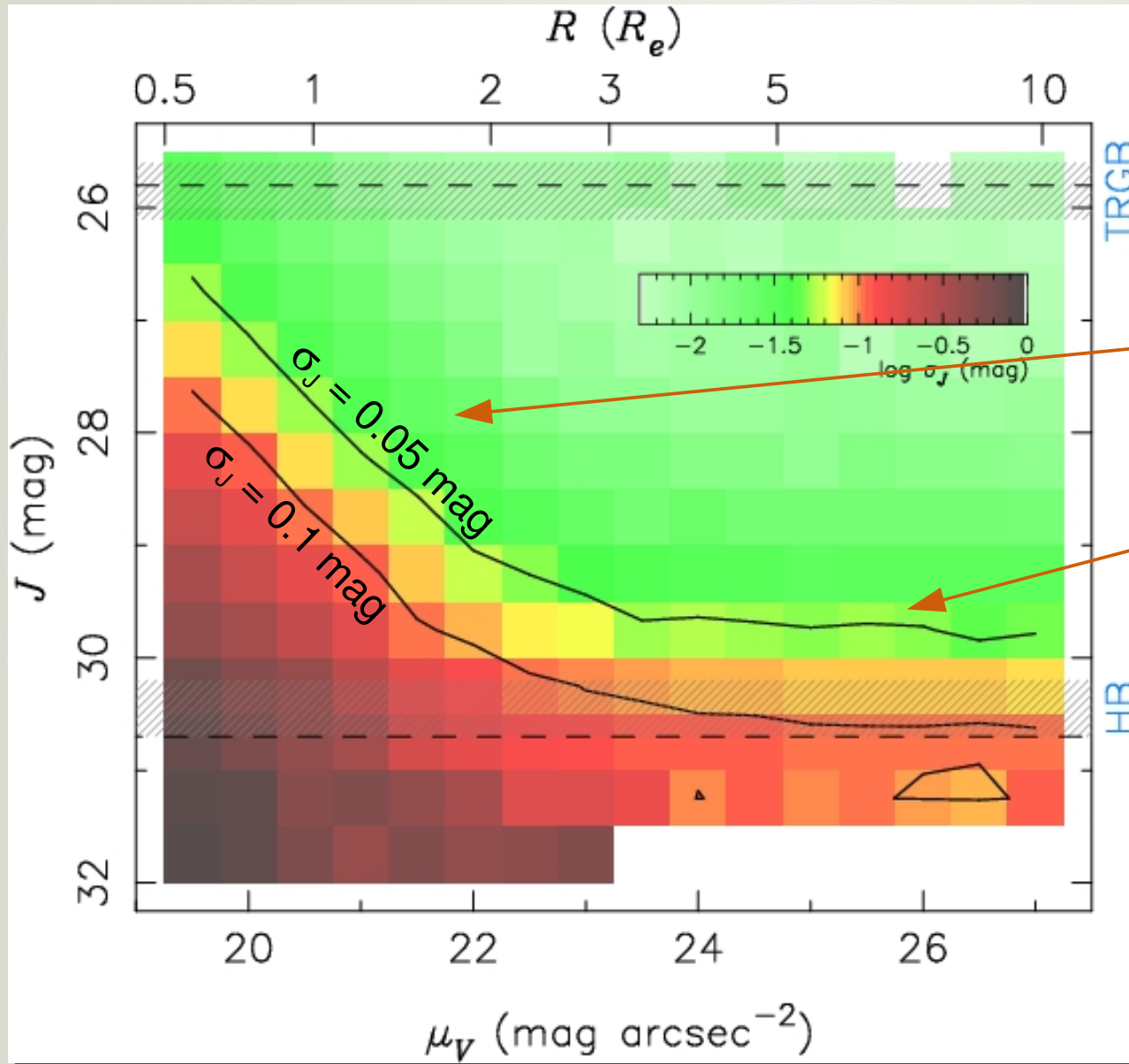

Crowding limited

Background limited
($T_{\text{exp}} = 100$ h)

Full result: M87

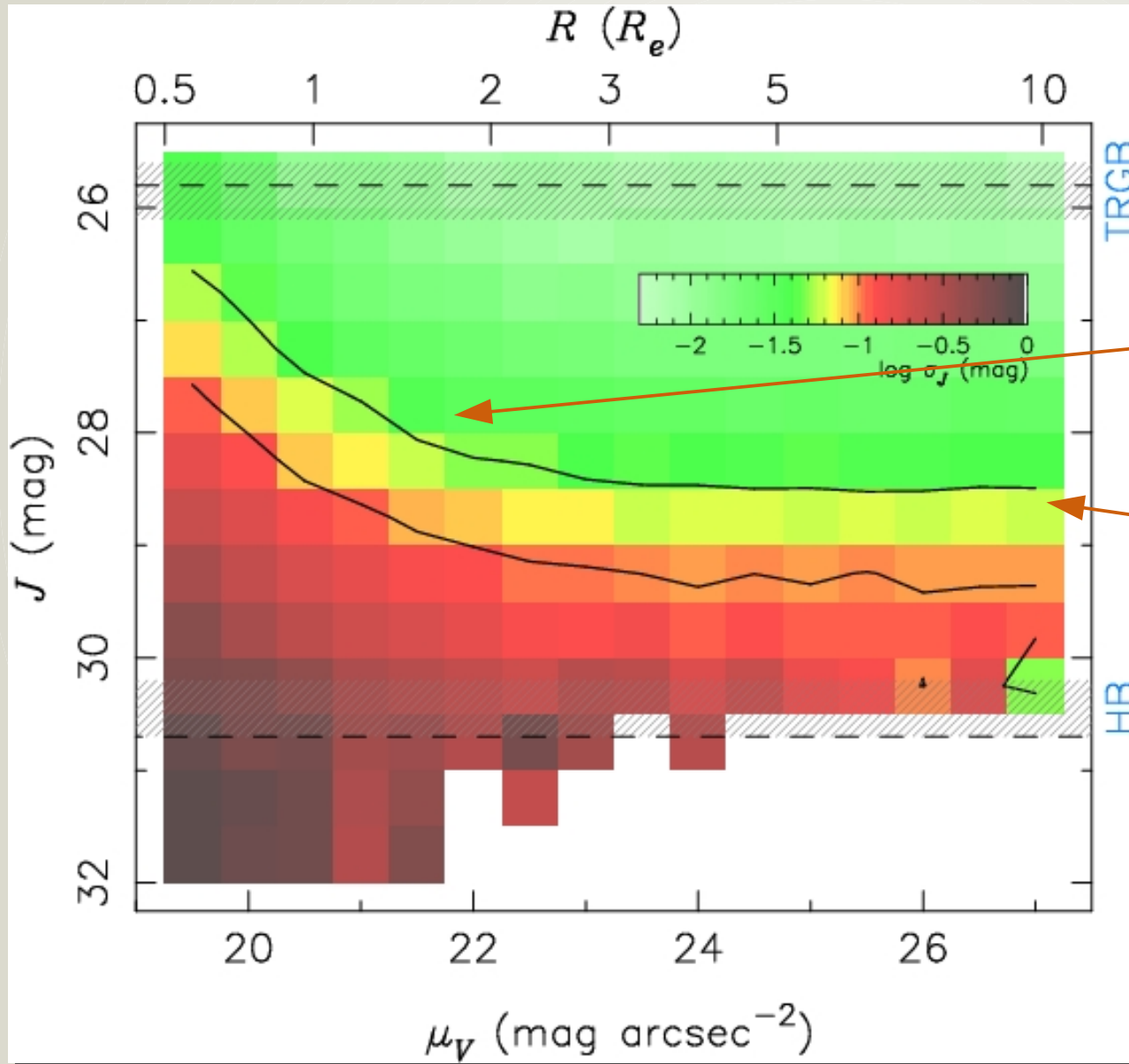

Crowding limited

Background limited
($T_{\text{exp}} = 10$ h)

Full result: M87

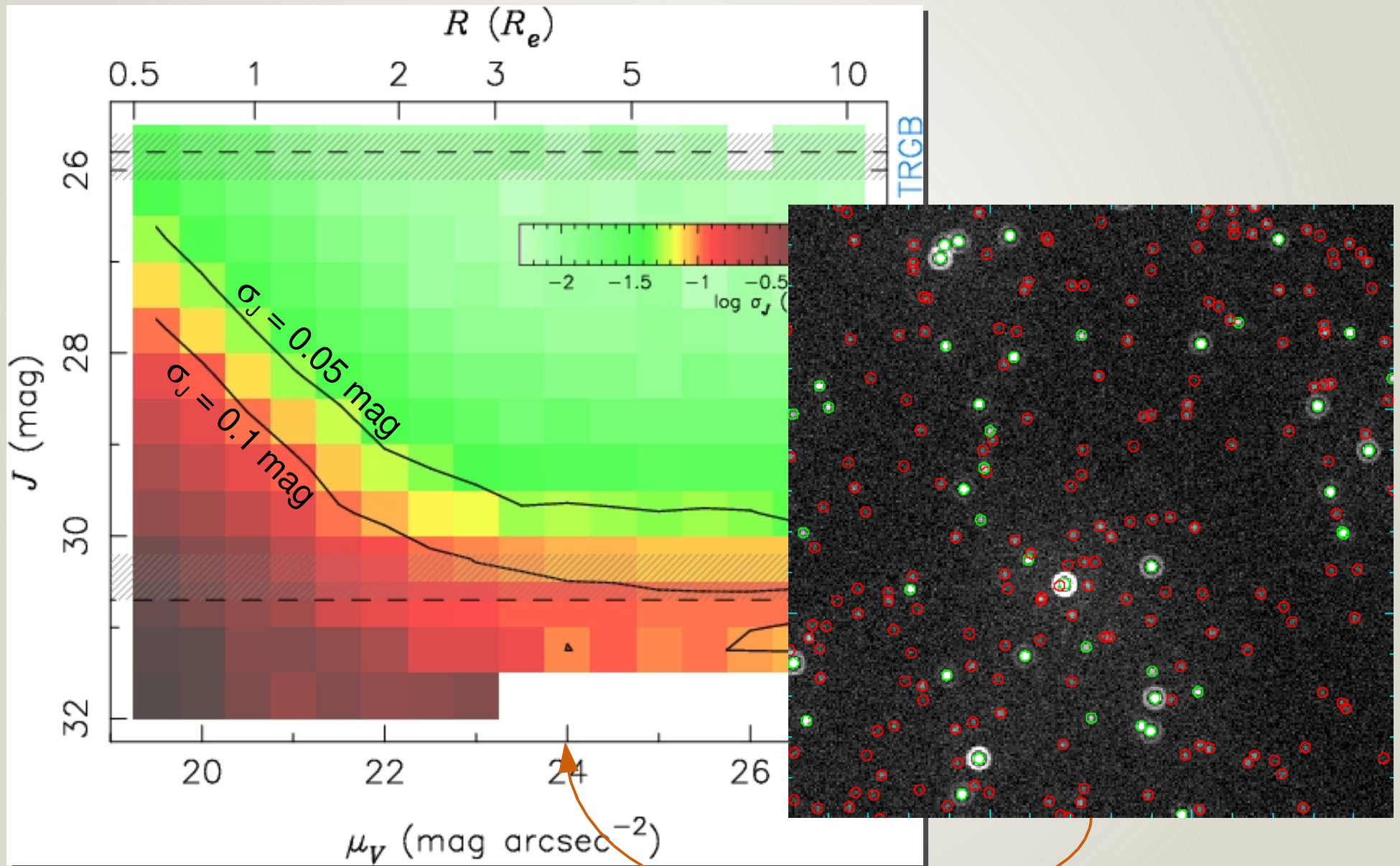

Full result: M87

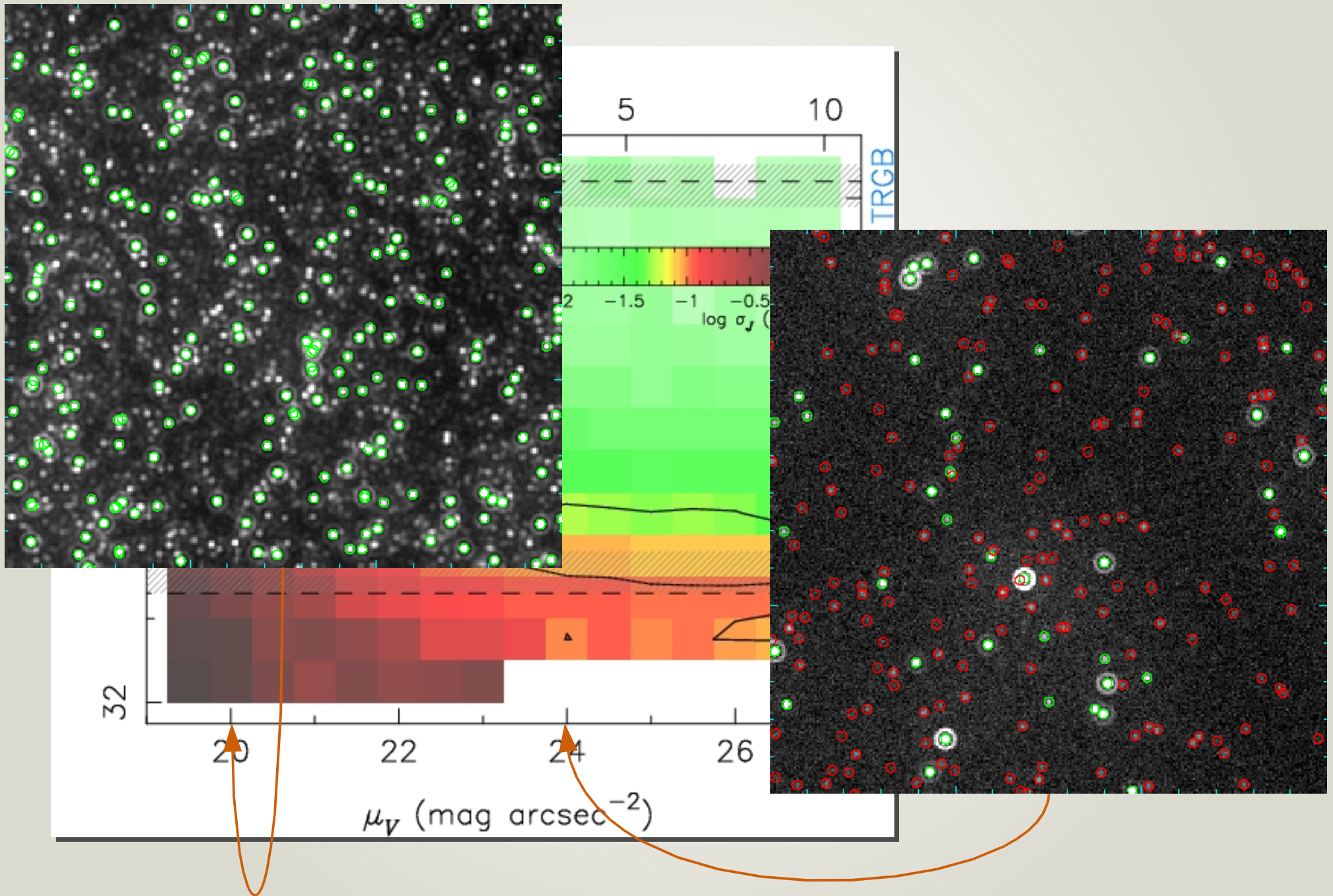

Full result: M87

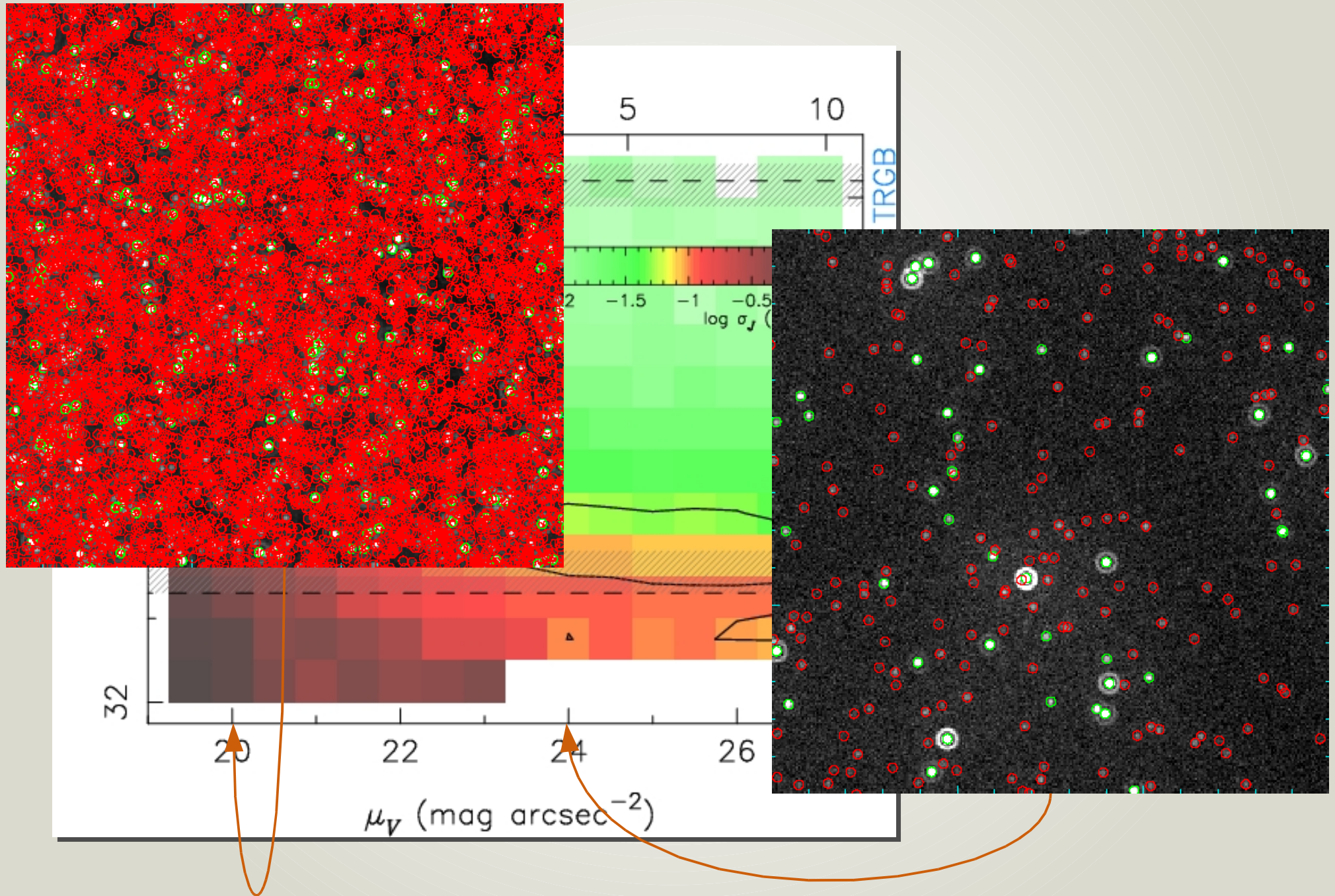

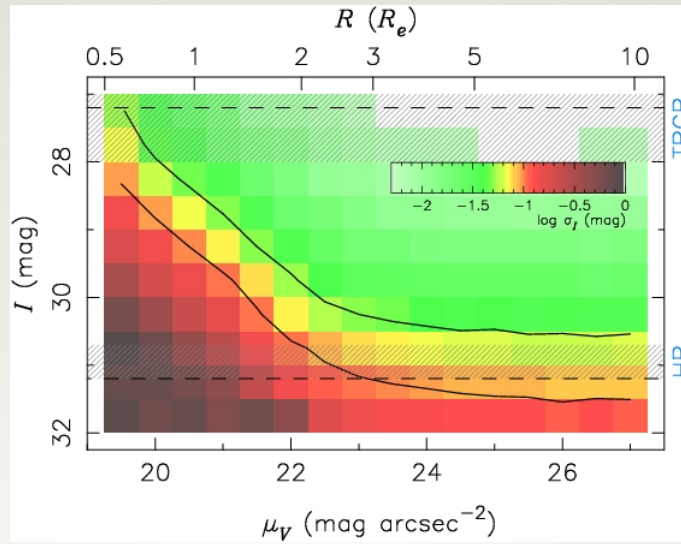
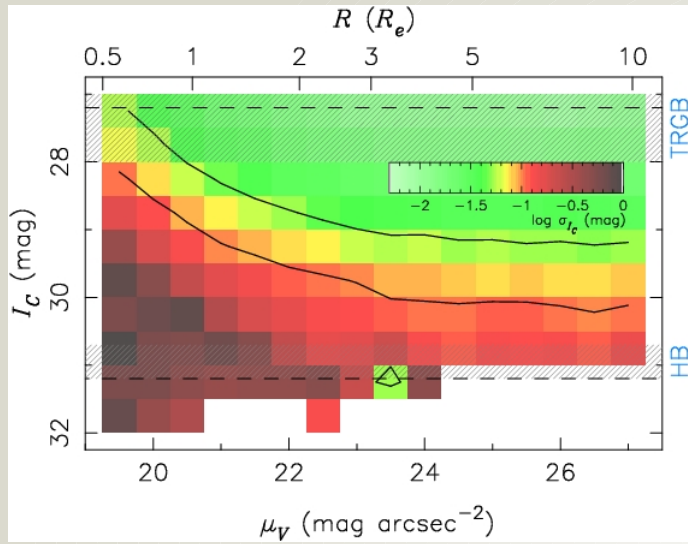

M87

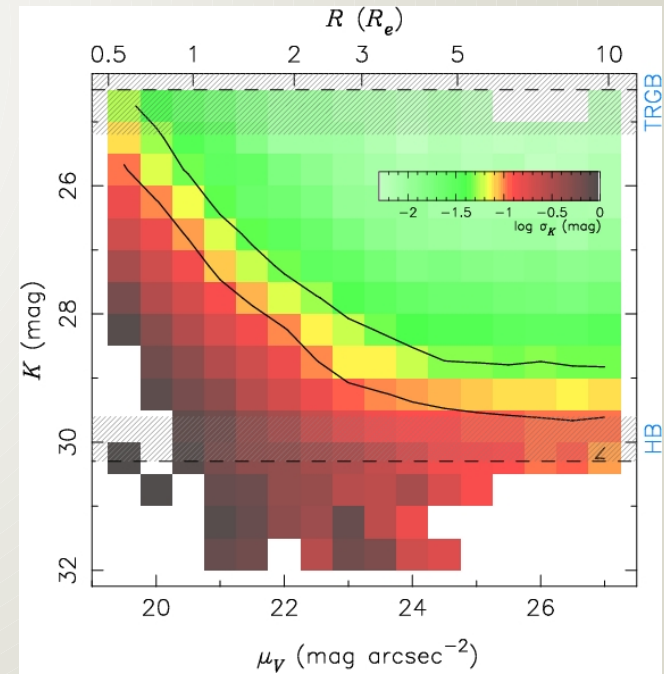
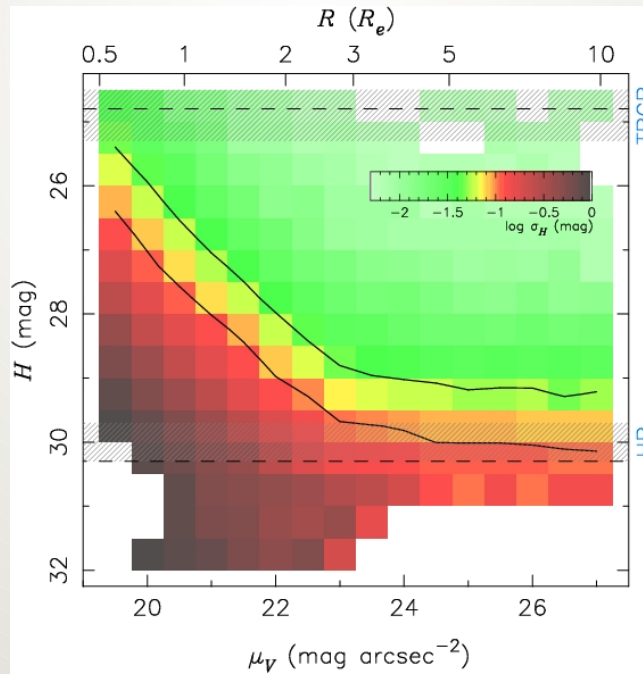
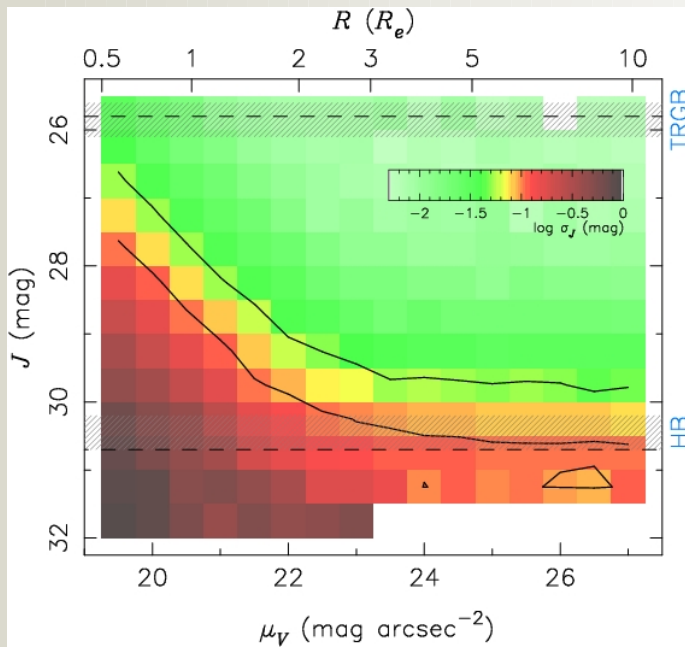

Cen A

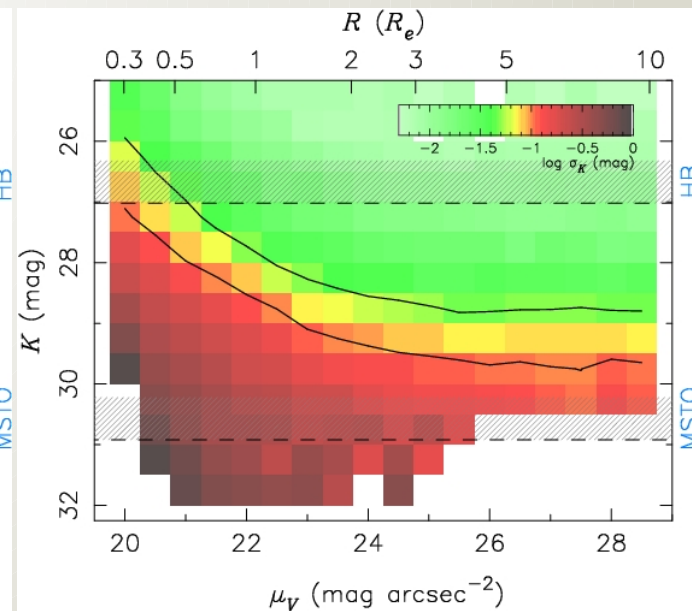
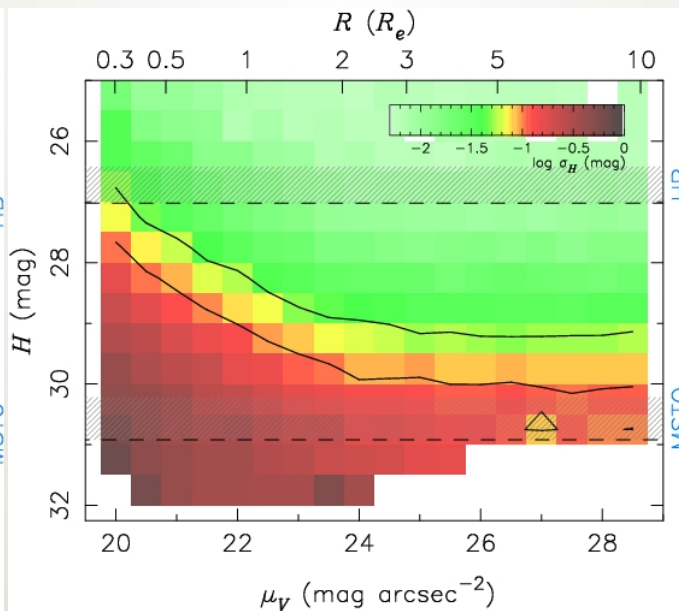
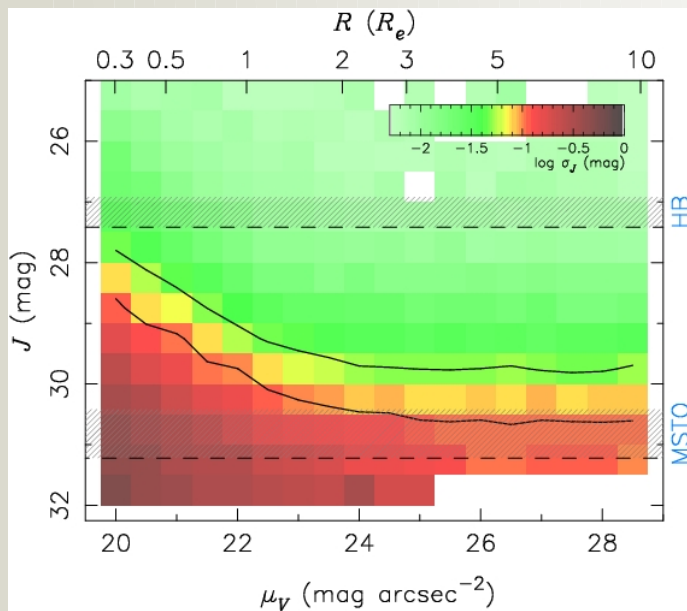
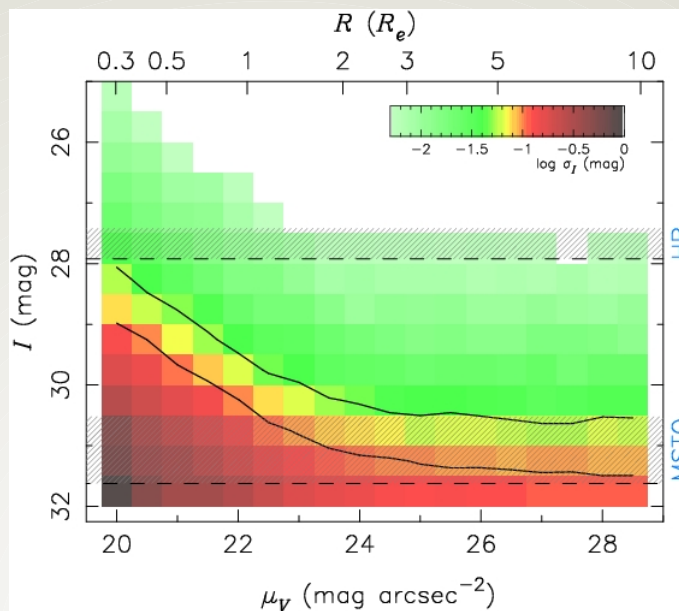
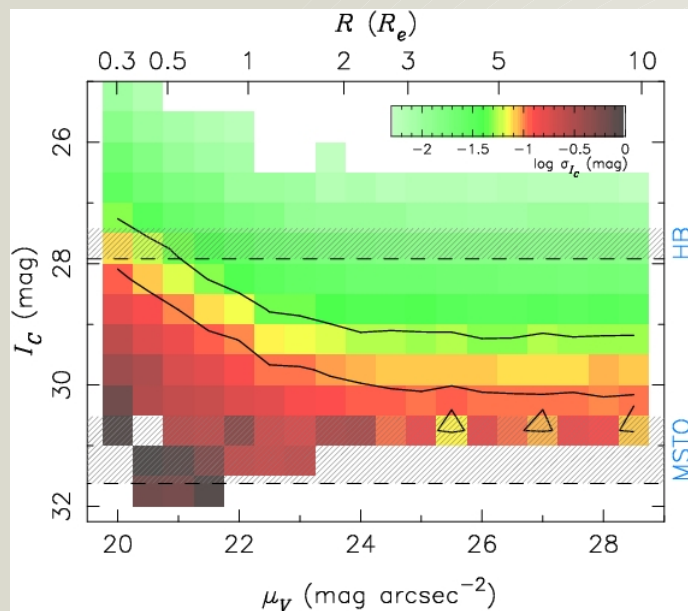

NGC 205

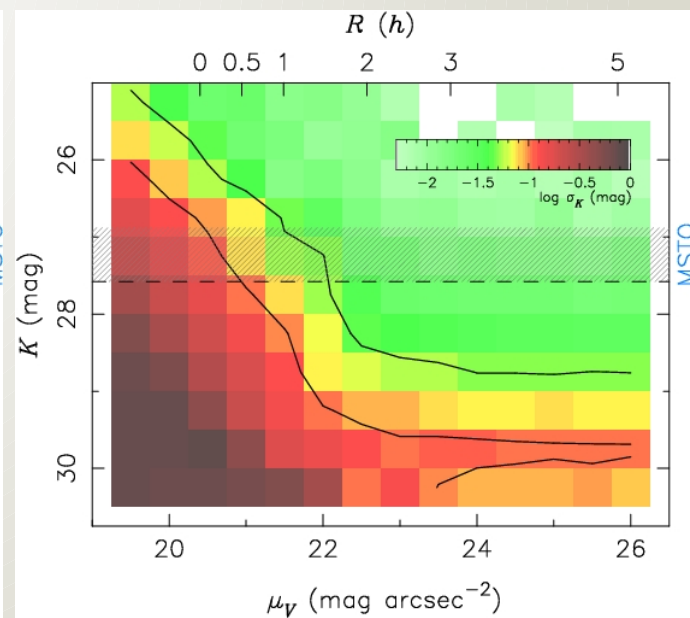
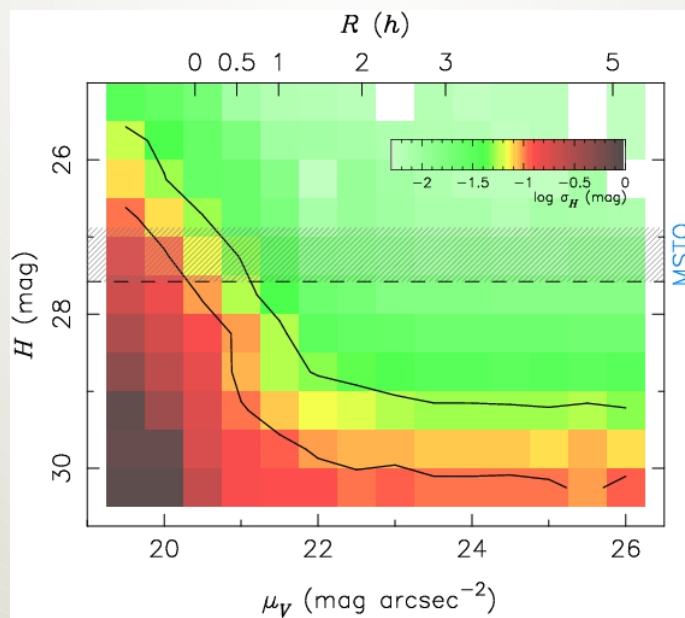
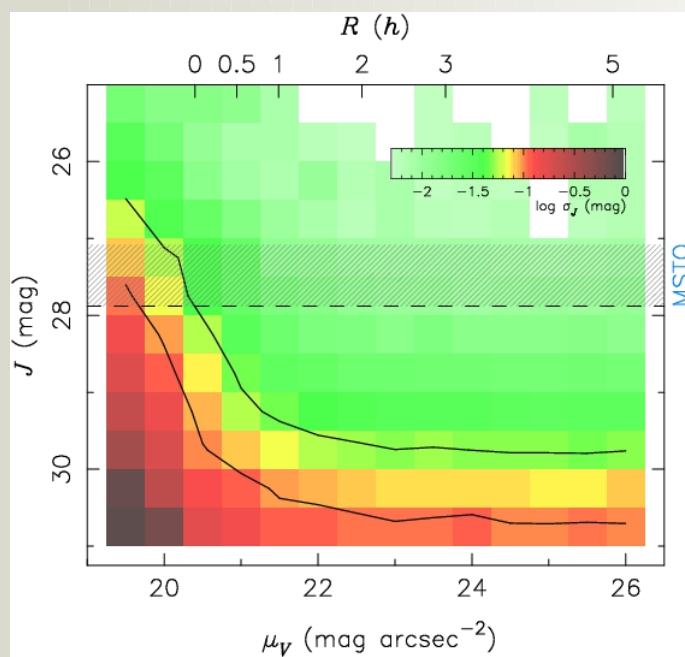
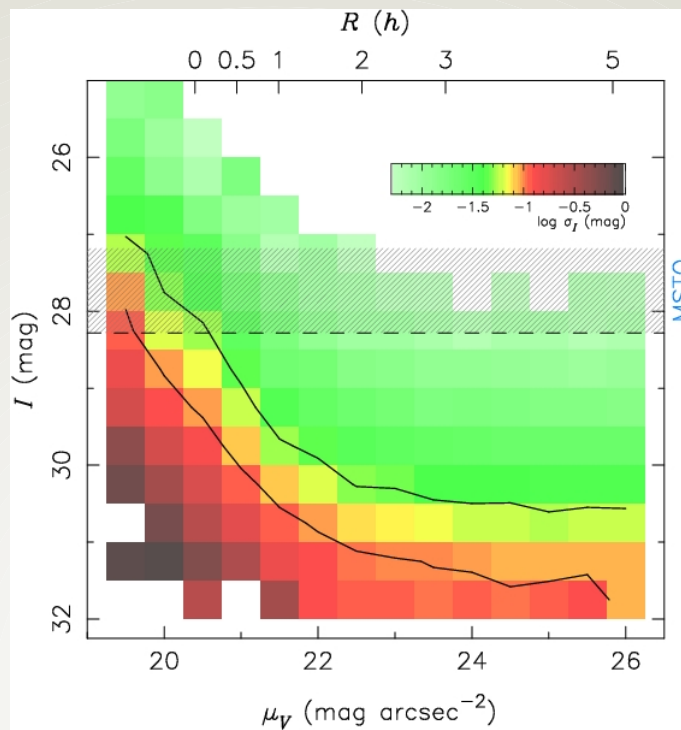
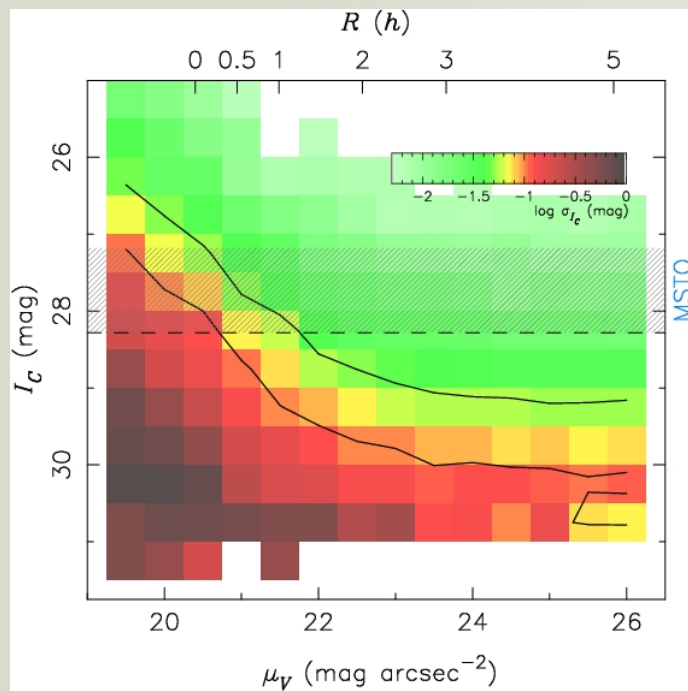

NGC 205

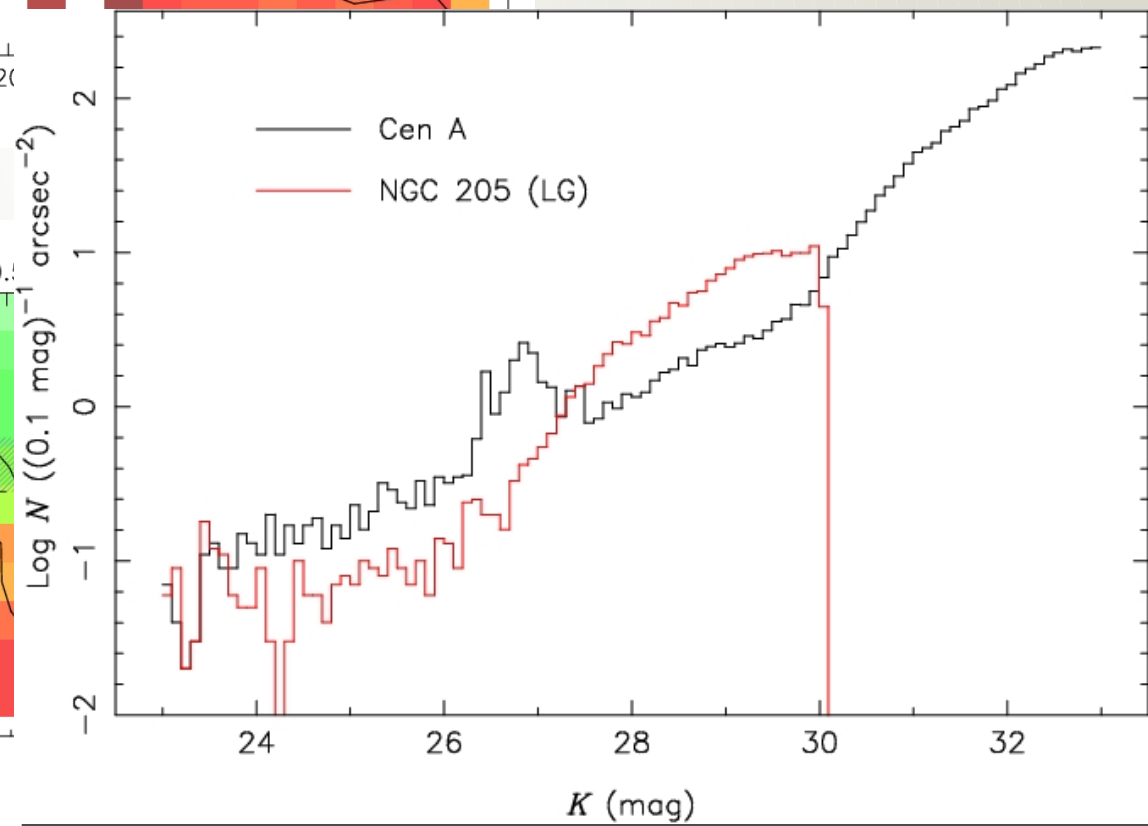
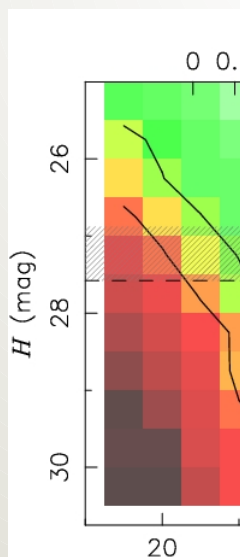
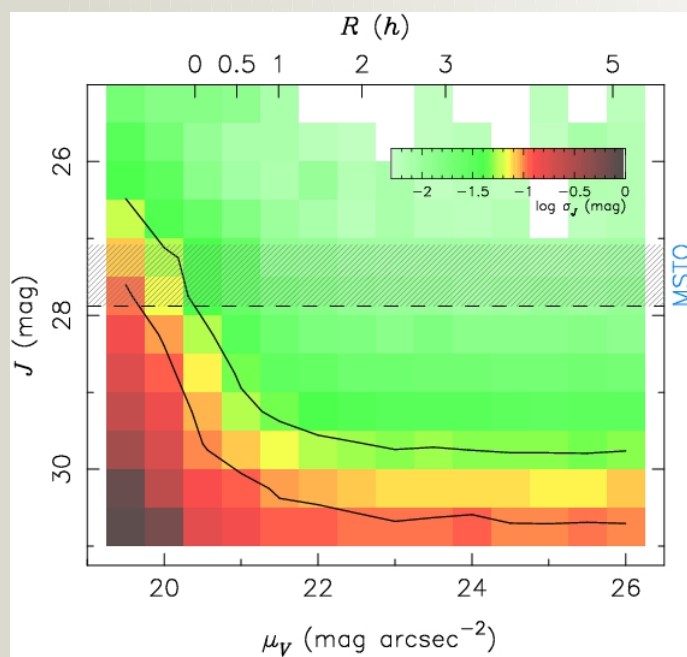
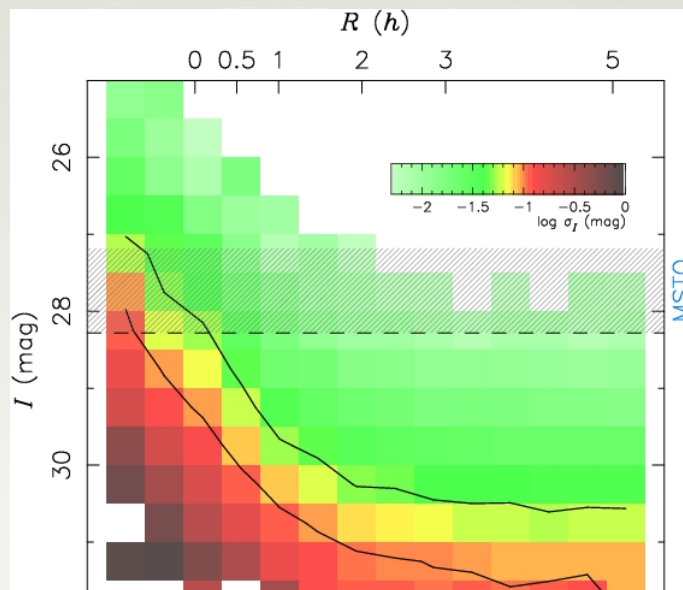
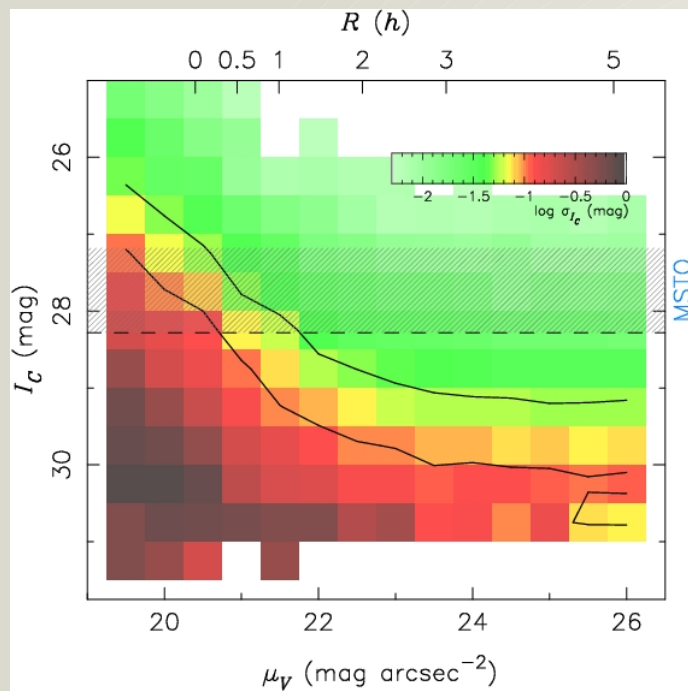

Effect of resolution

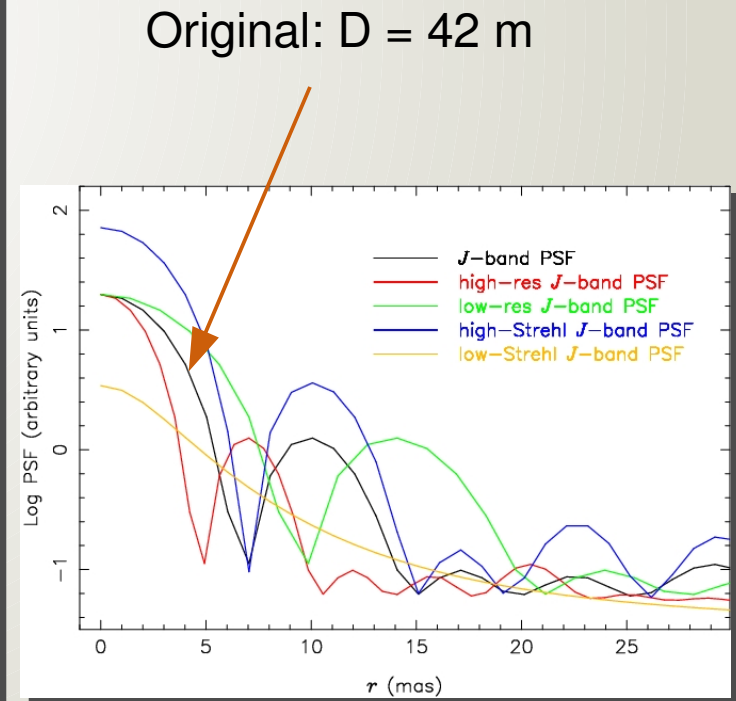
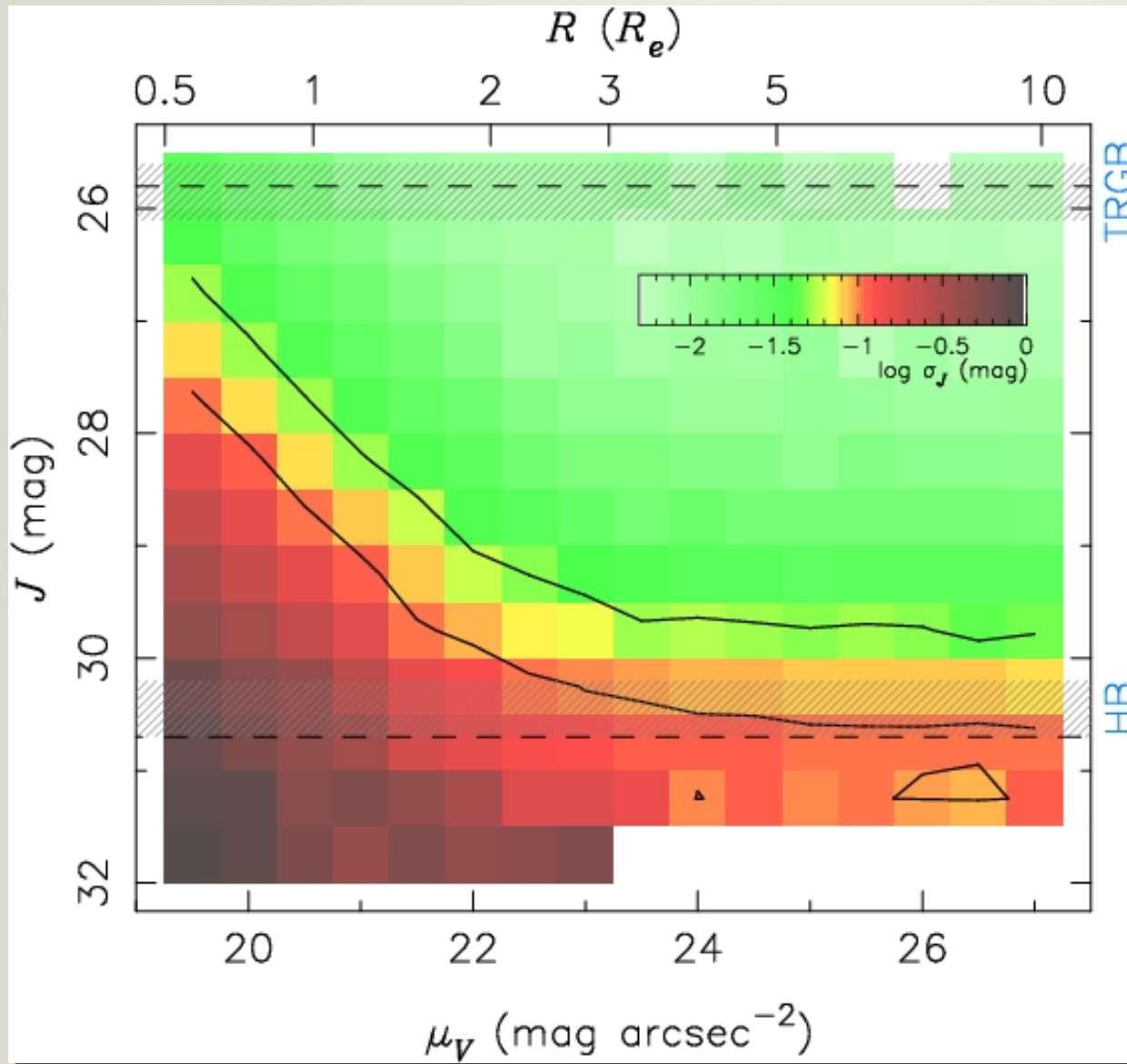

Effect of resolution

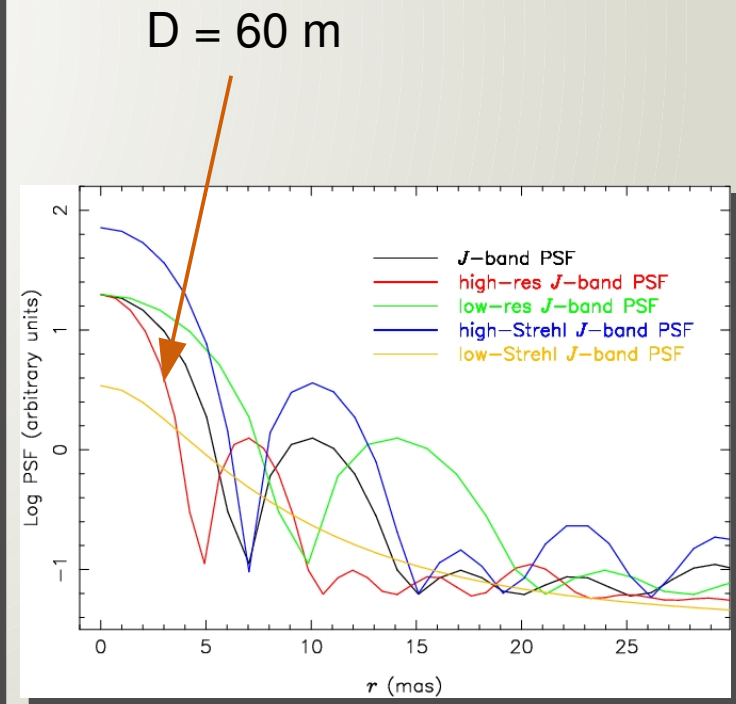
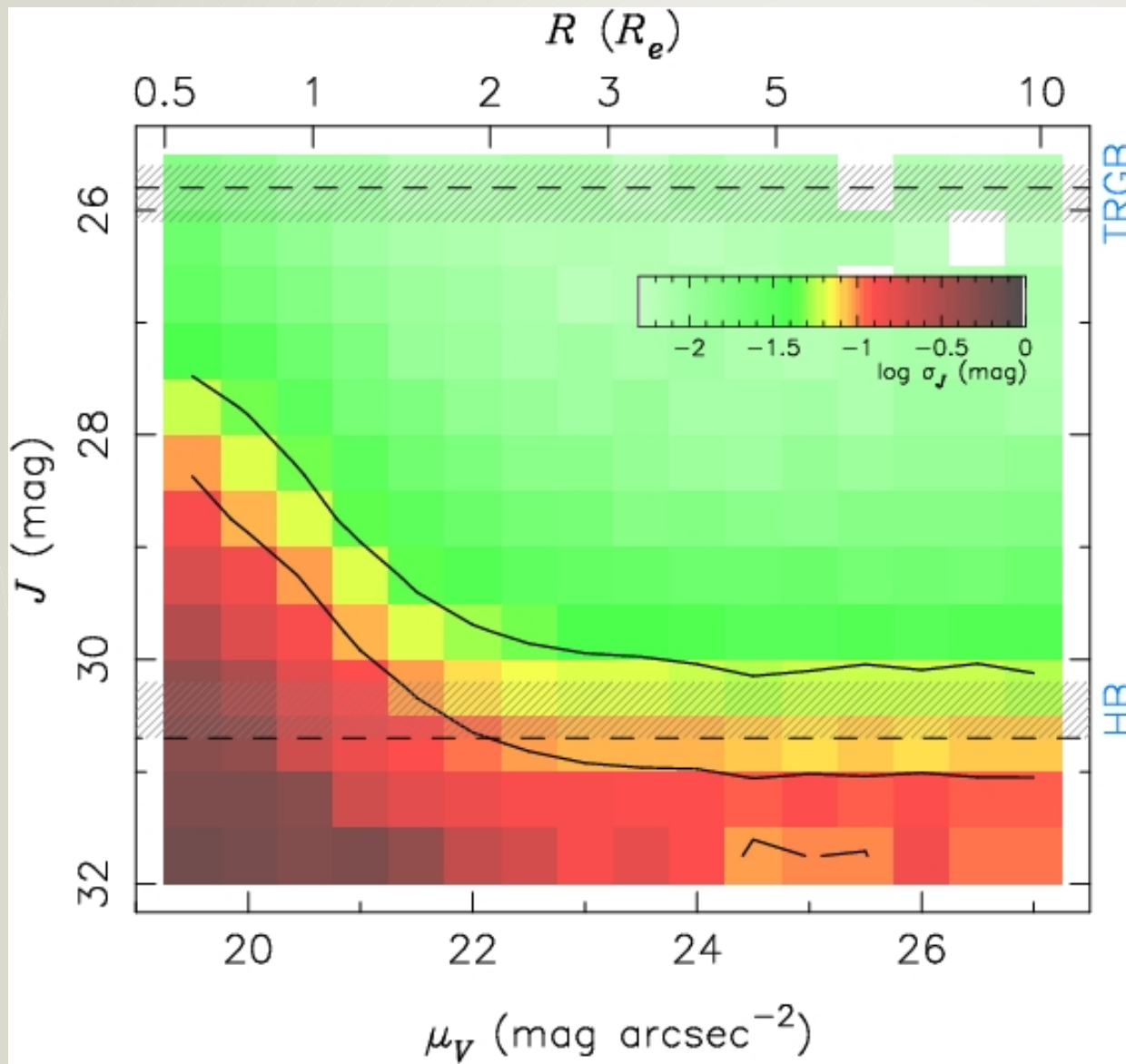

Effect of resolution

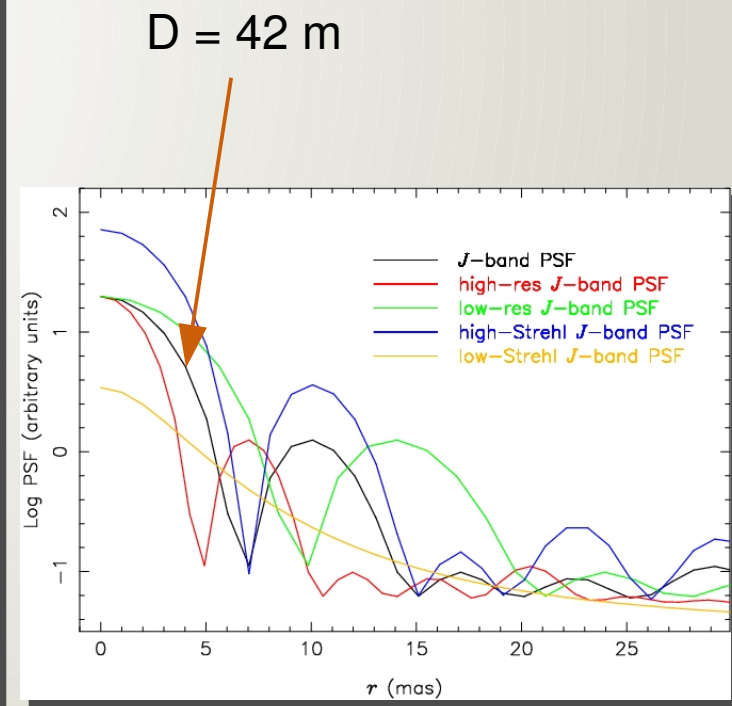
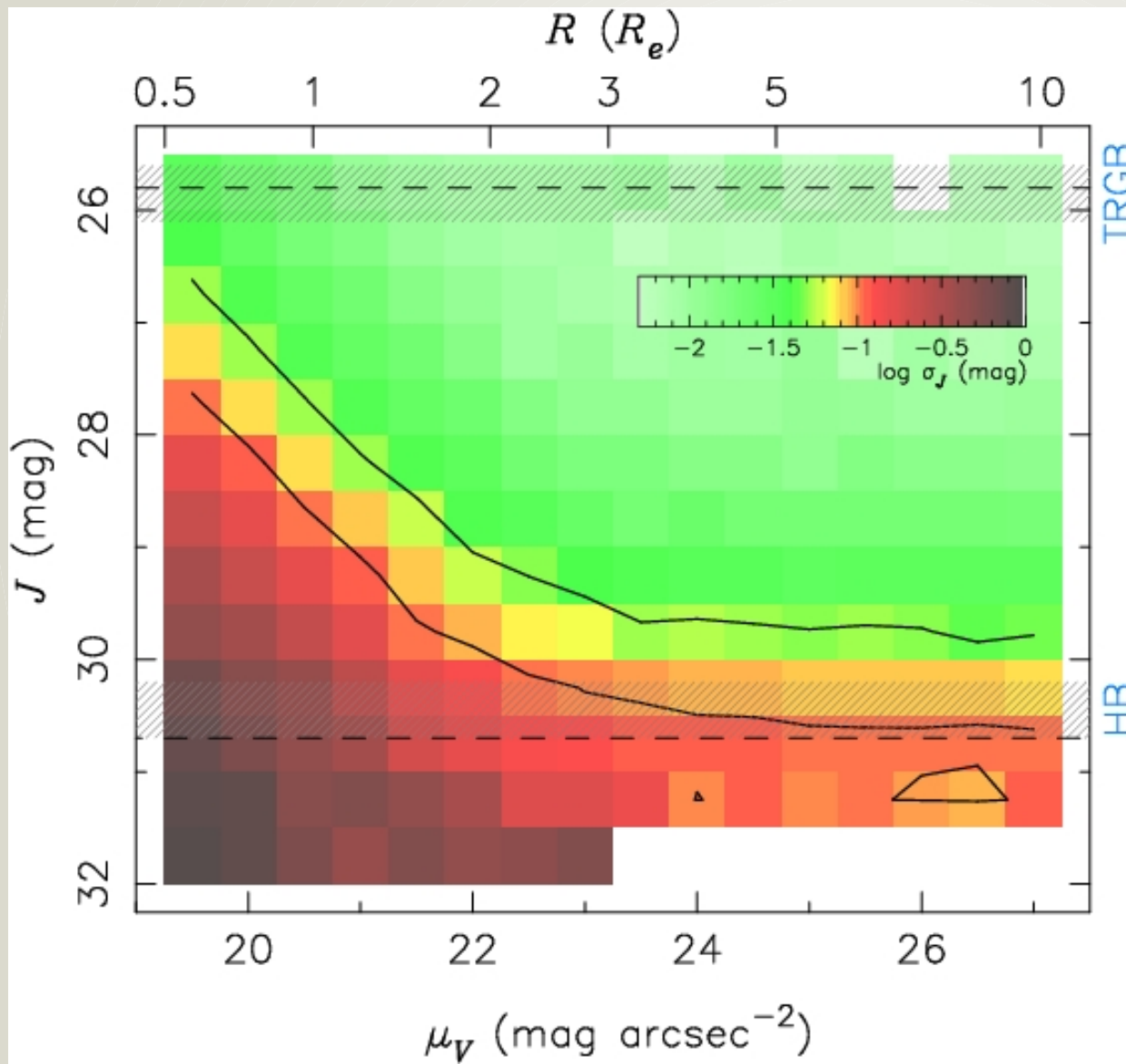

Effect of resolution

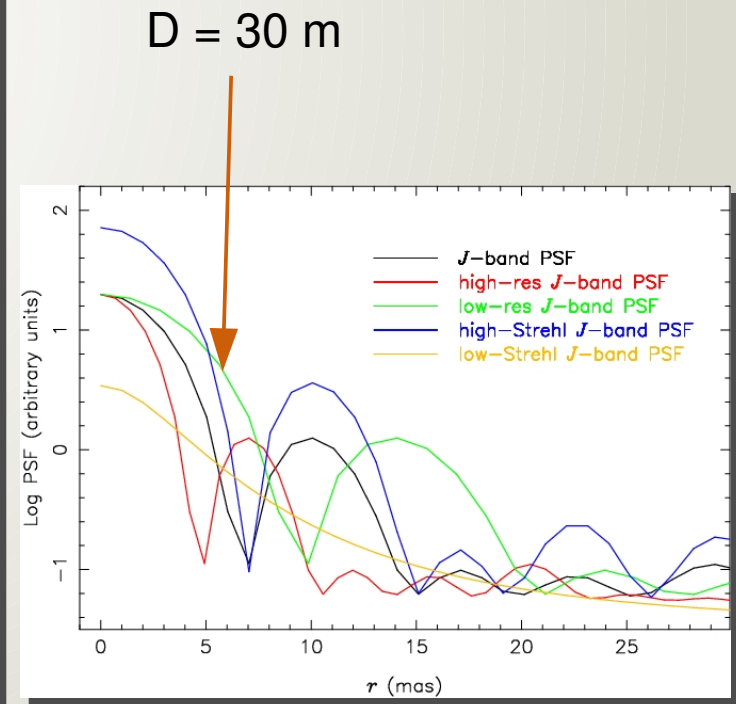
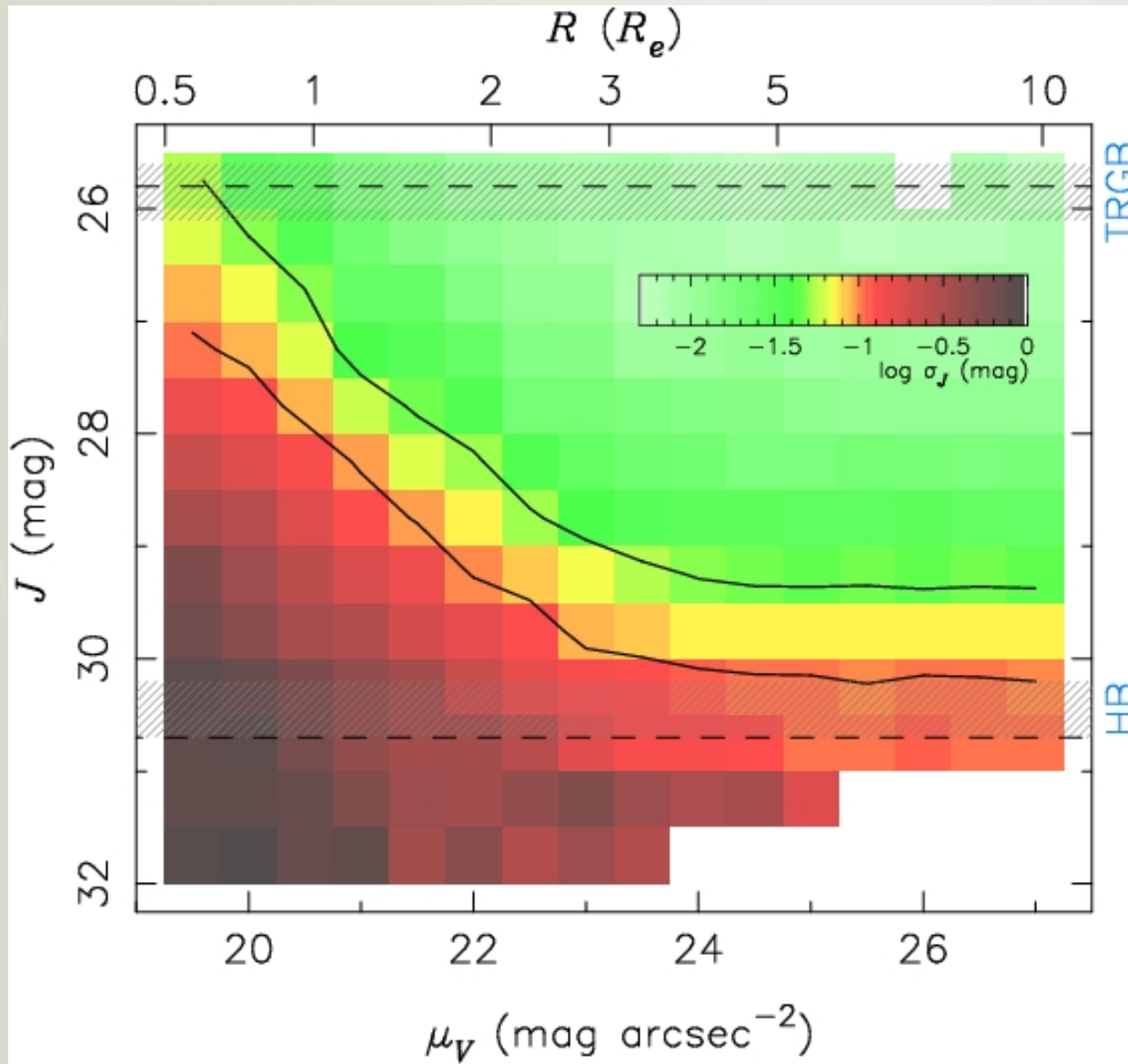

Effect of AO performance

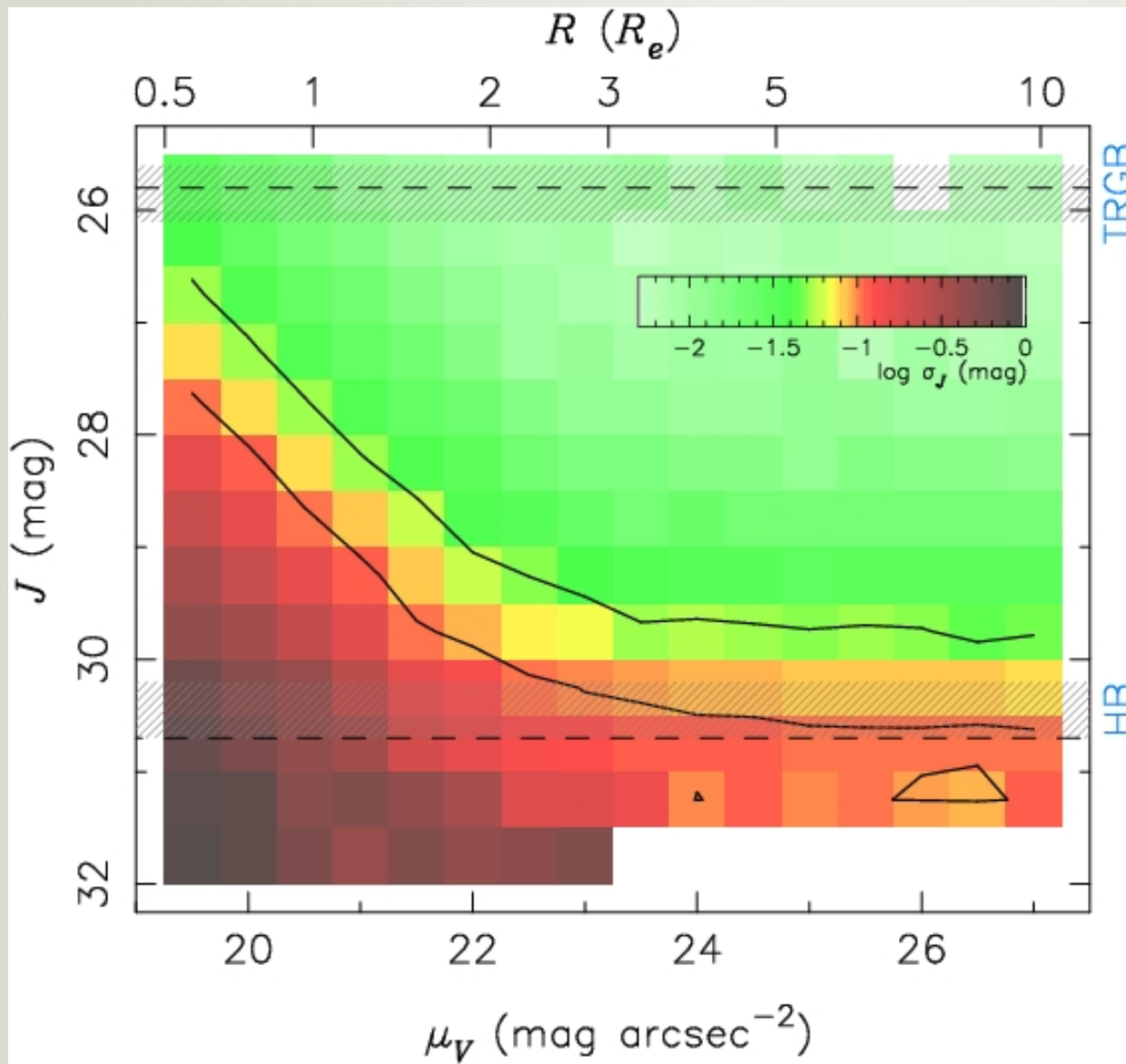

Original: intermediate Strehl

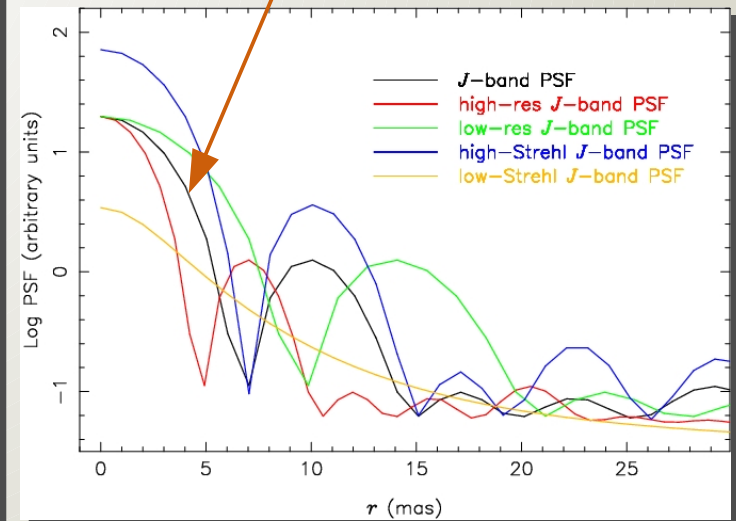

Effect of AO performance

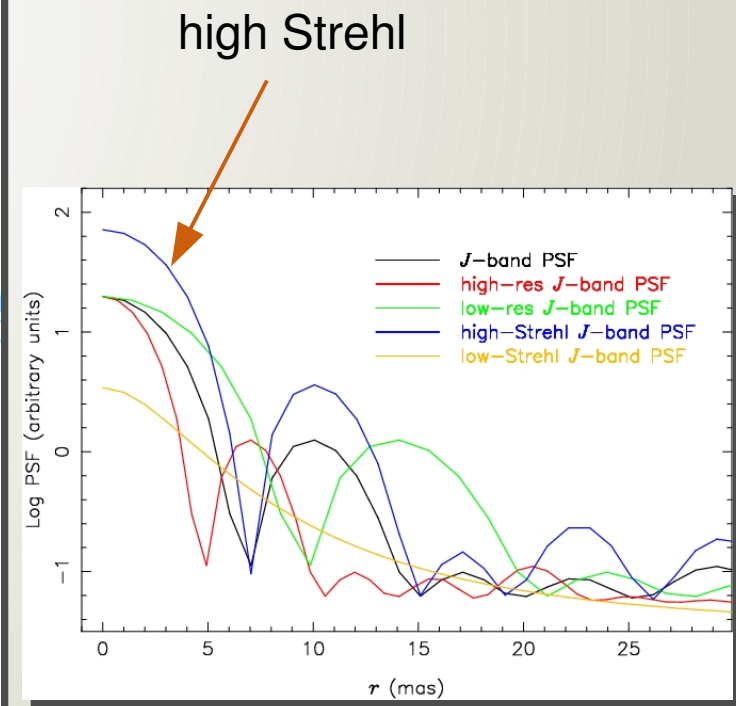
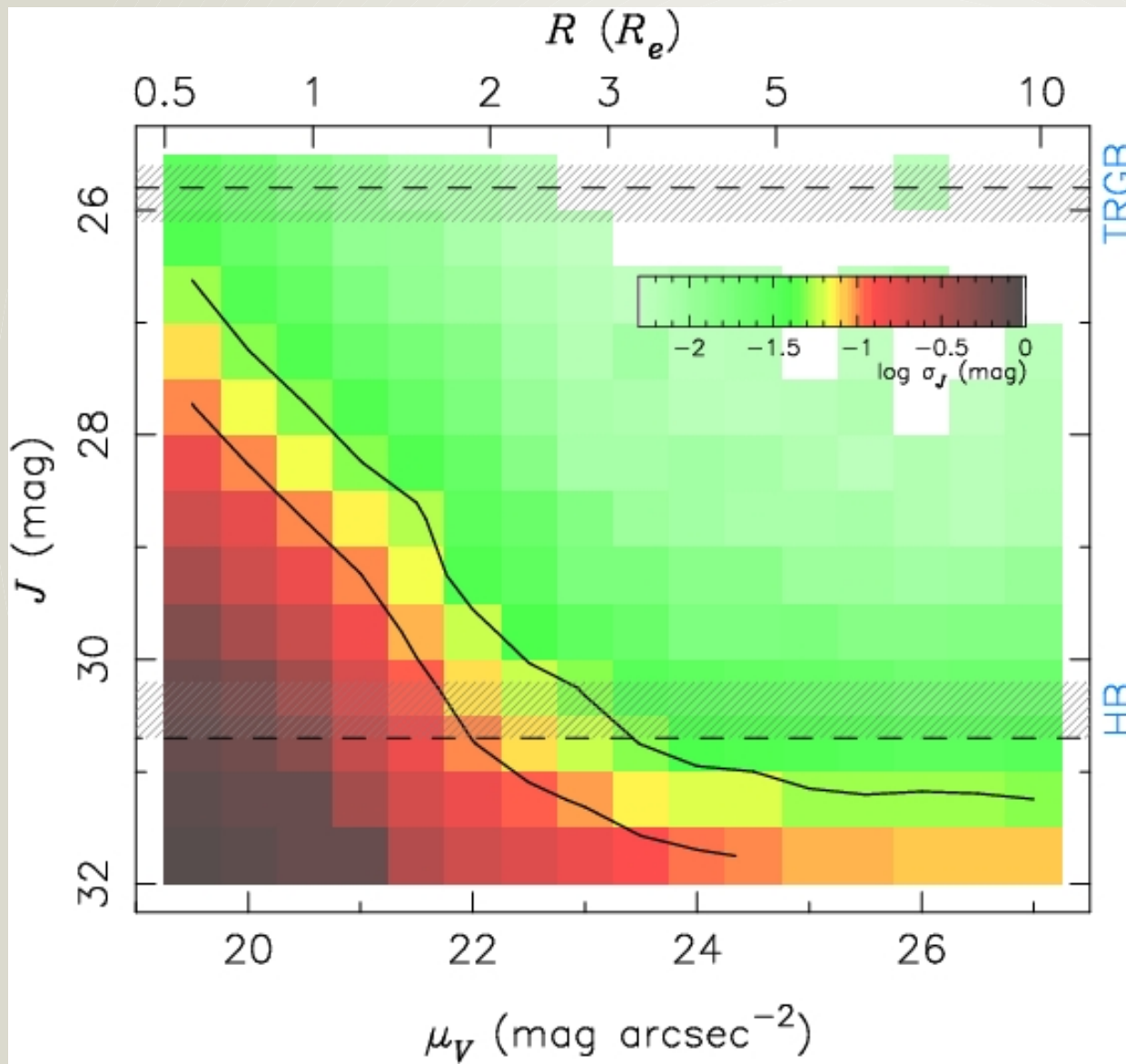

Effect of AO performance

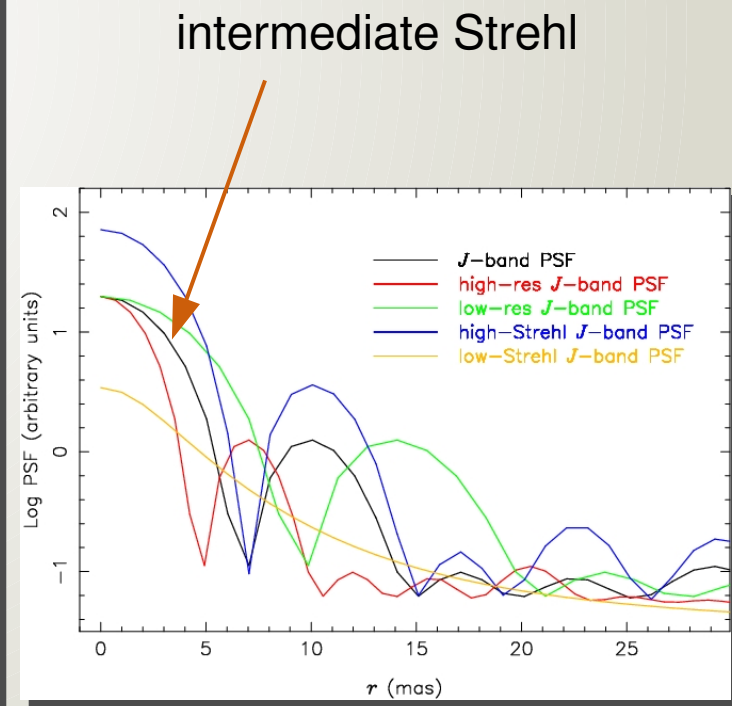
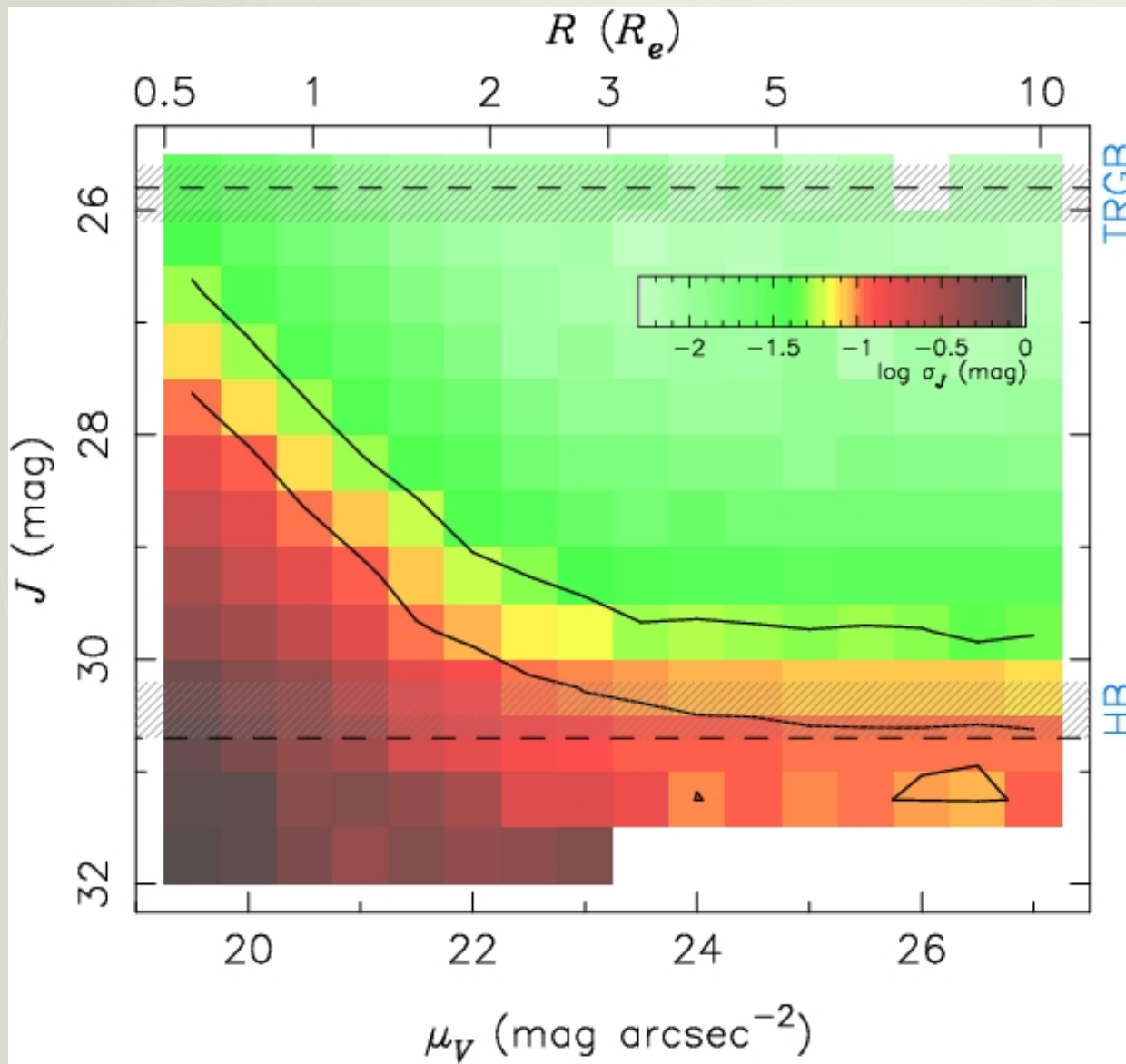

Effect of AO performance

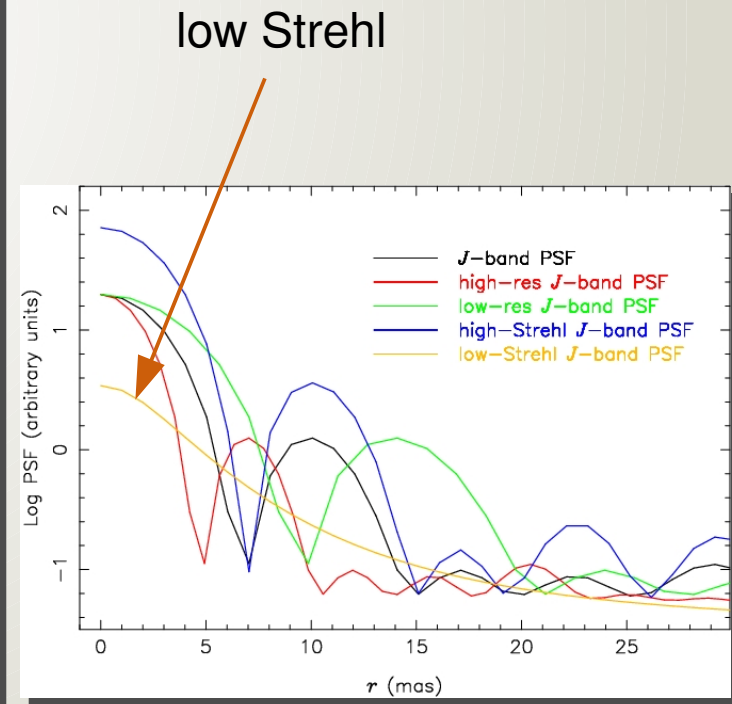
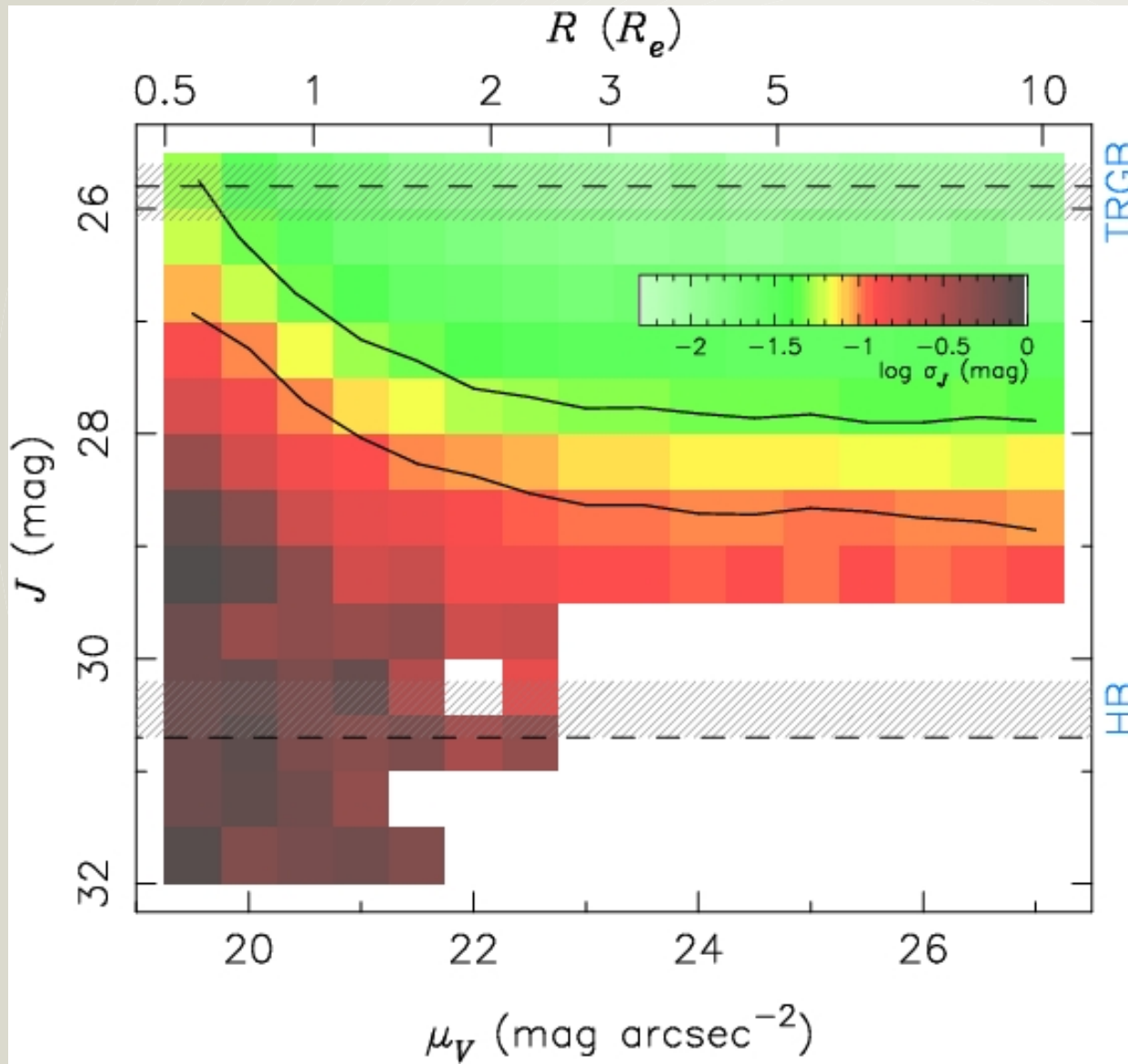

AO performance

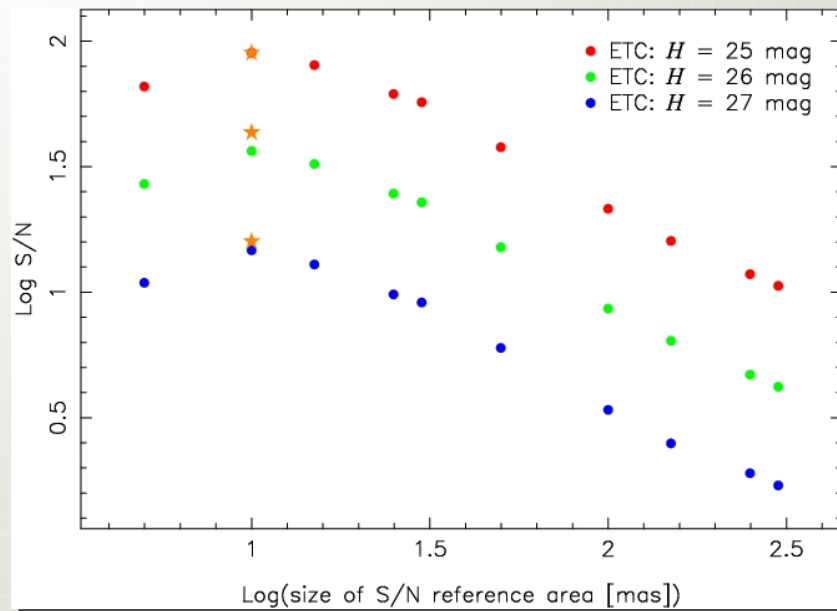
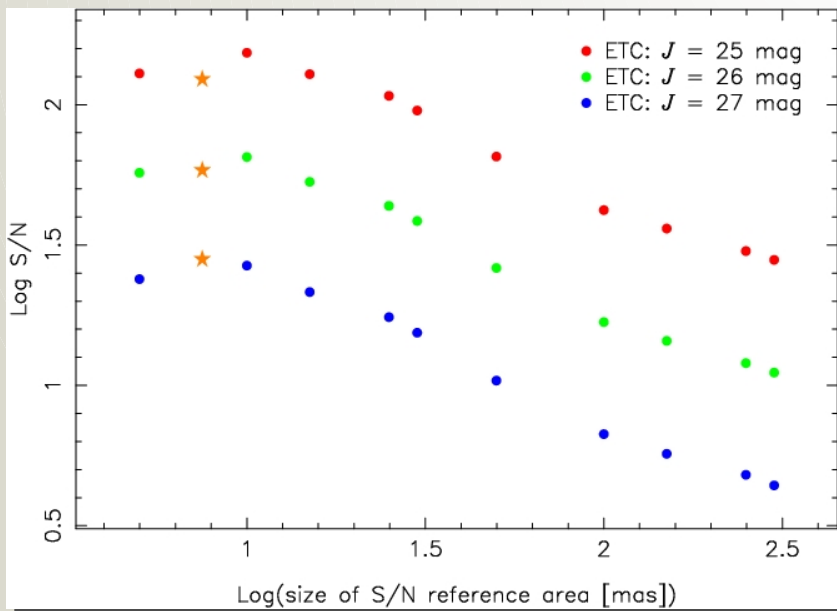
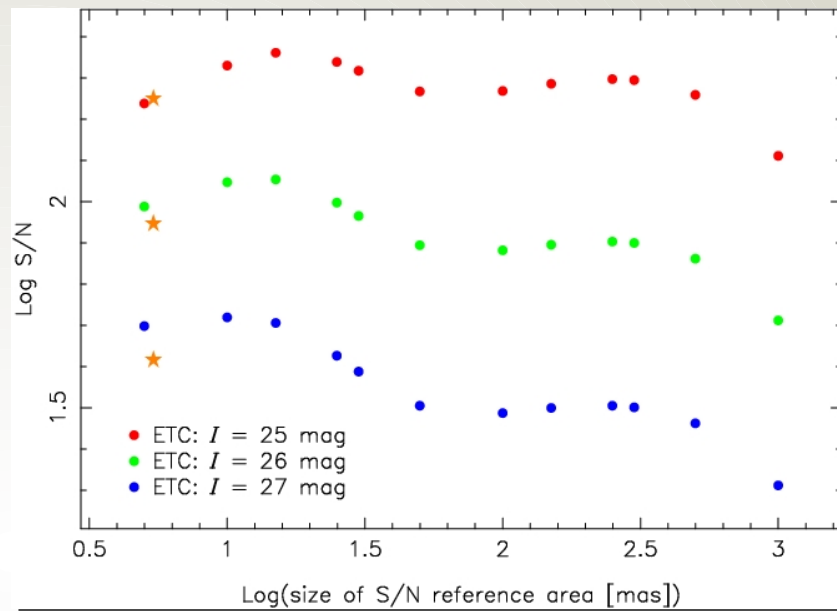
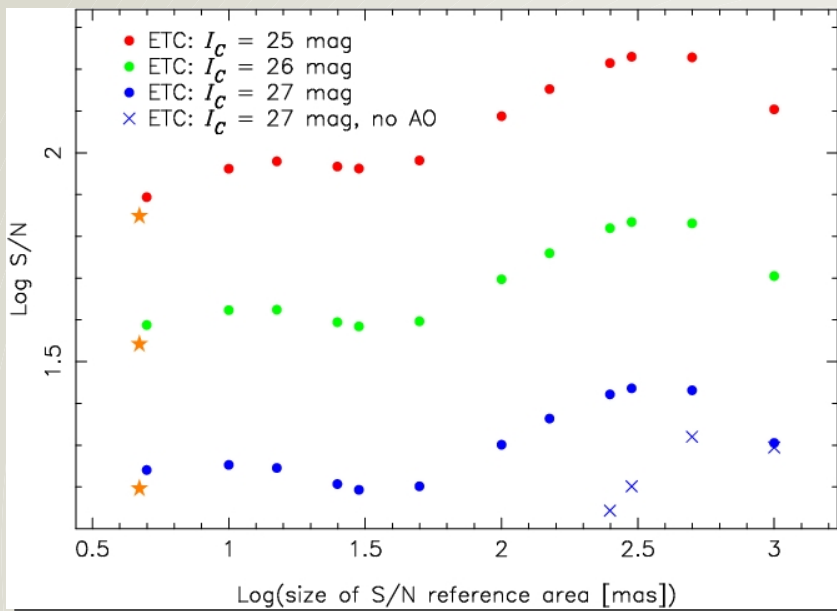

Effect of stellar population

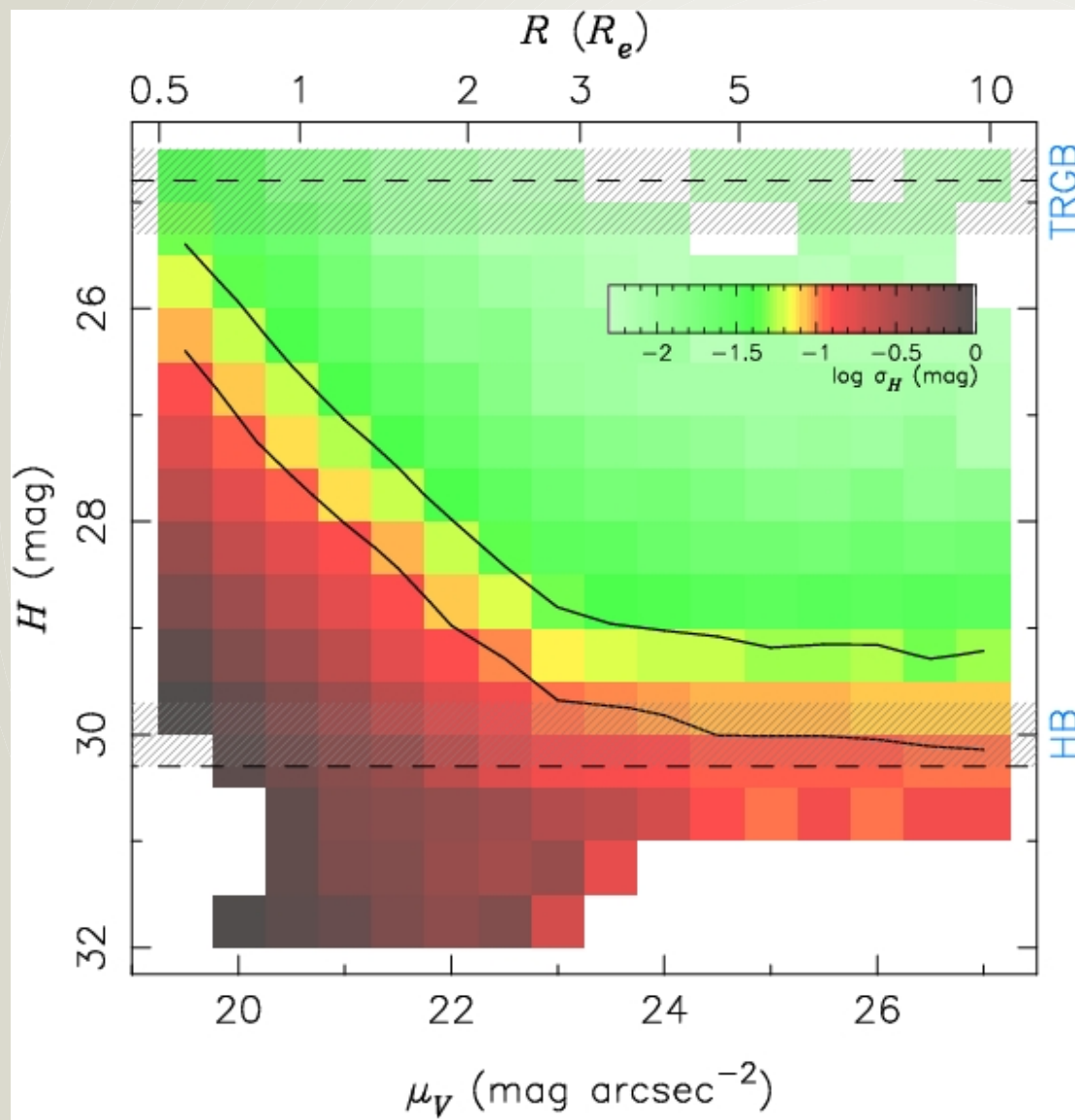

Original: intermediate metallicity

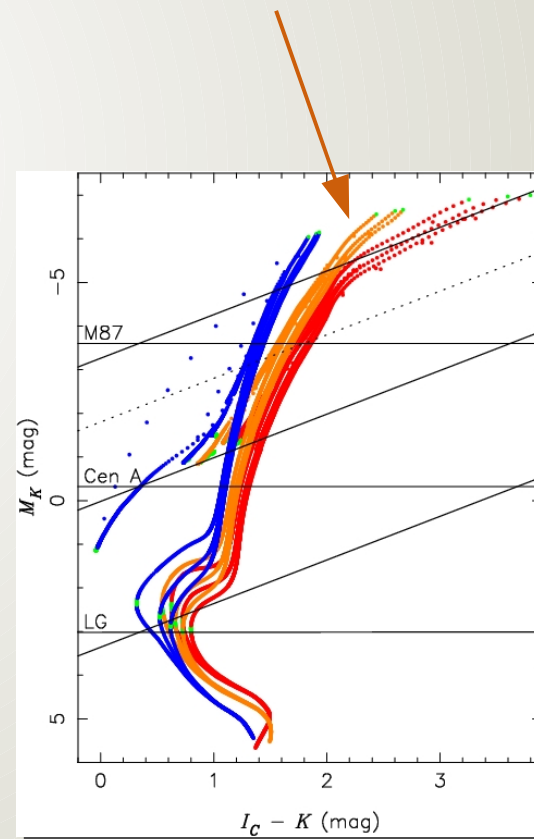

Effect of stellar population

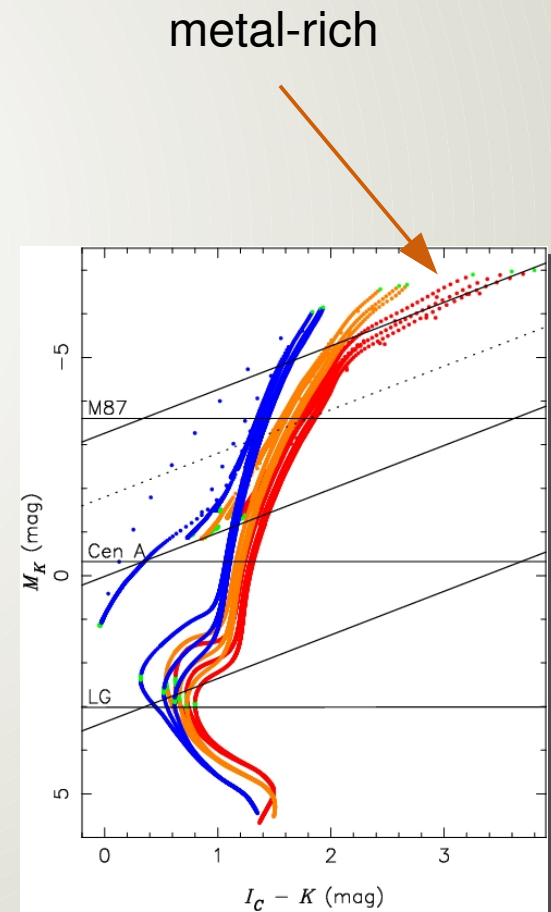
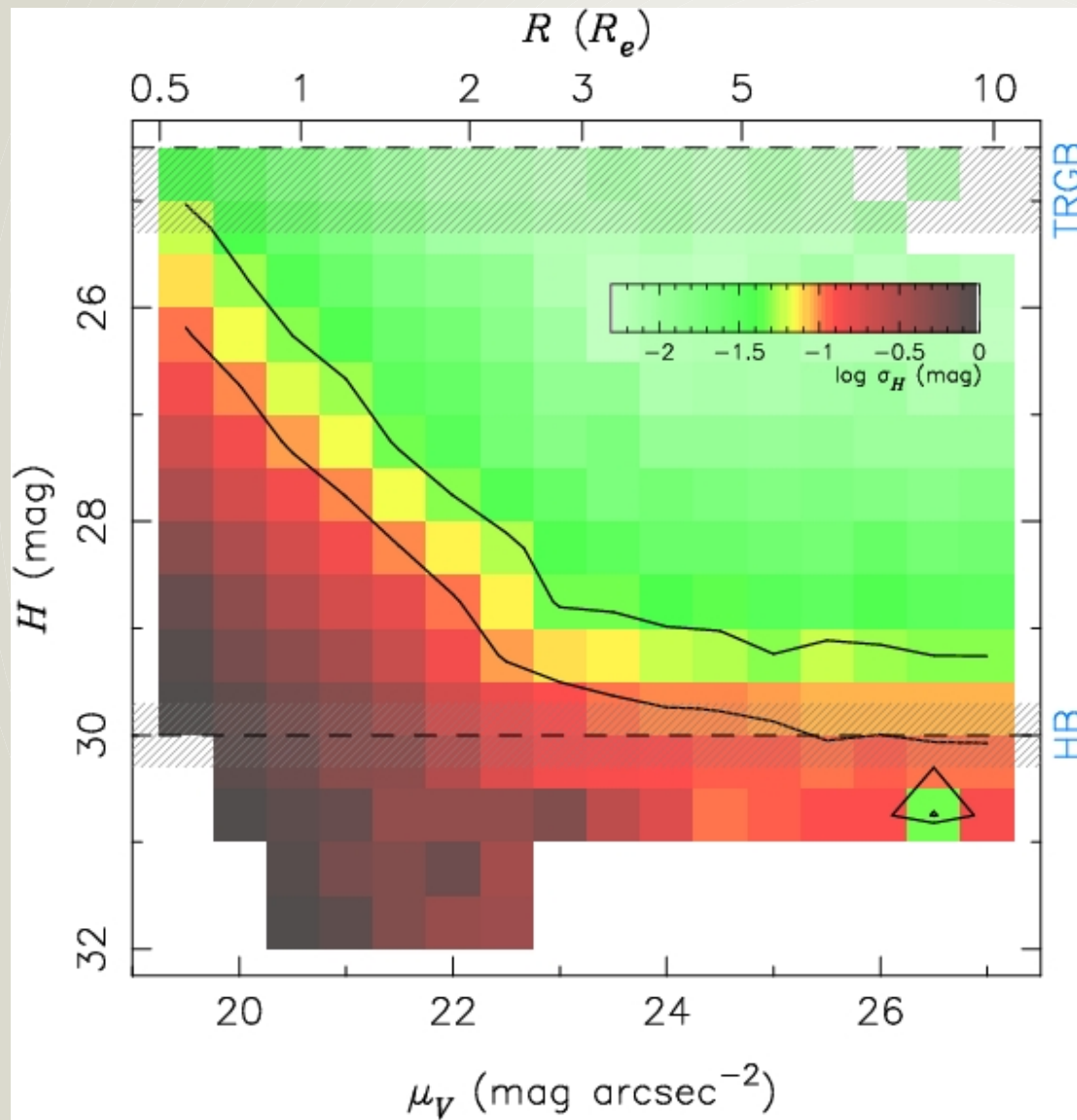

Effect of stellar population

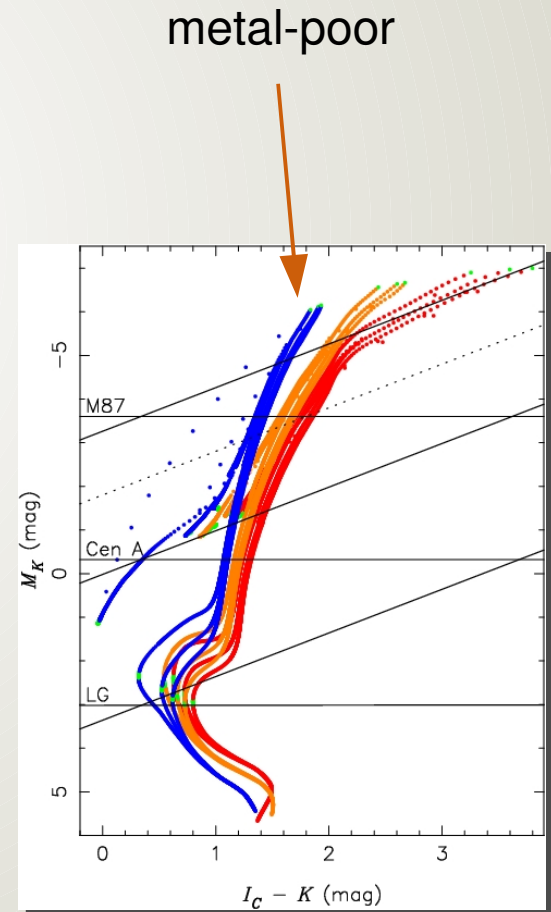
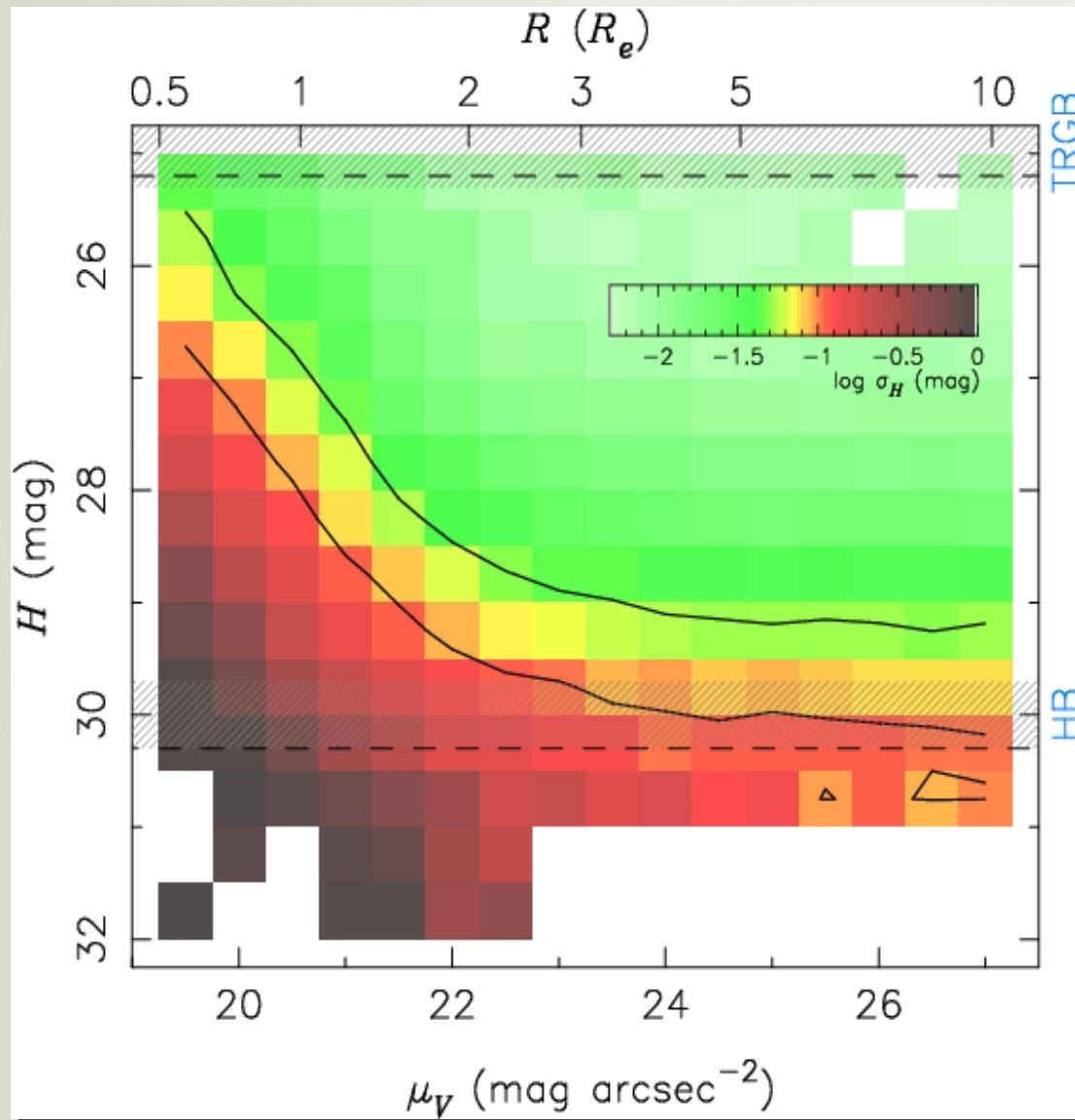

Effect of PSF errors

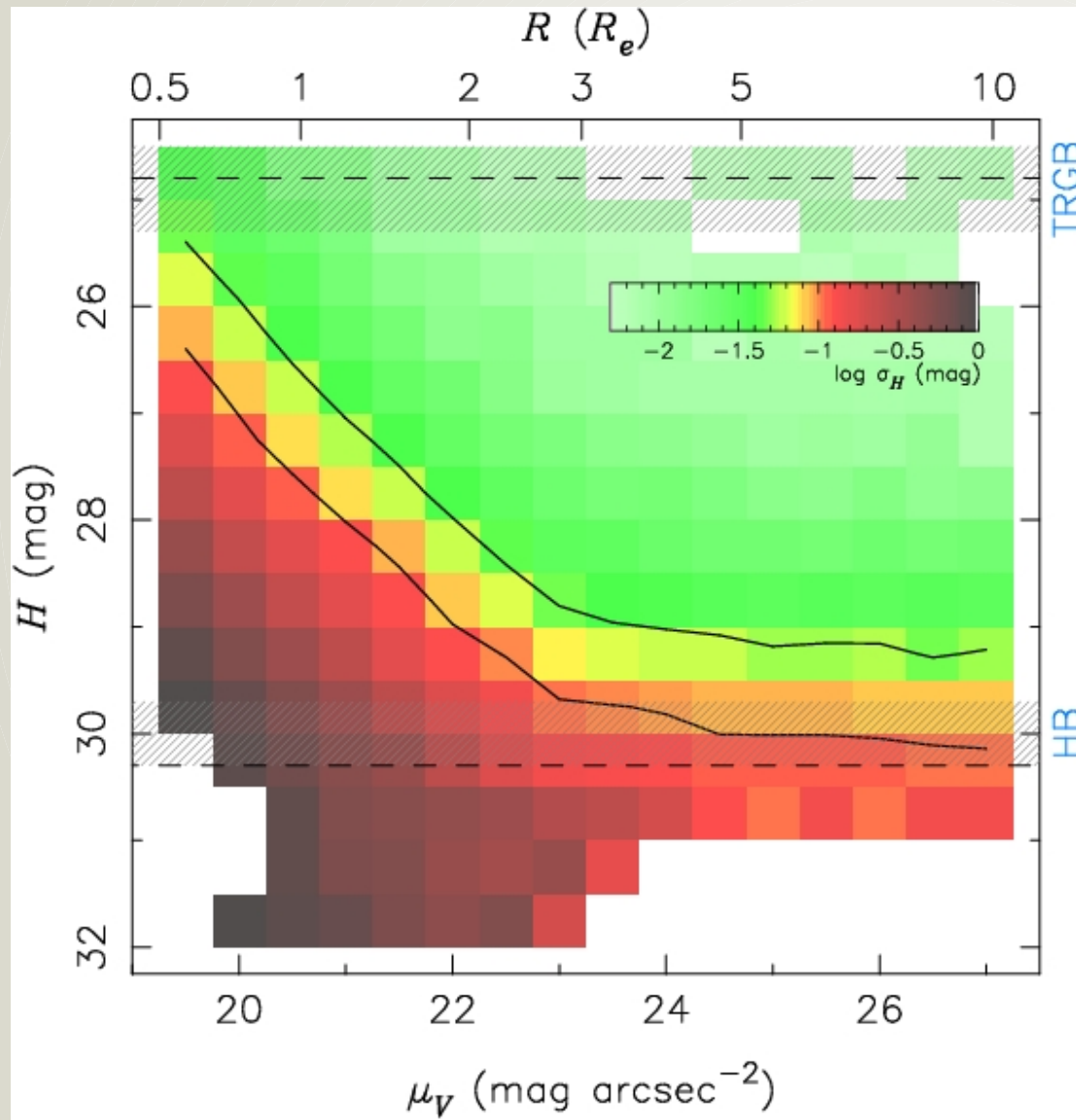

Using different PSFs for the image generation and analysis.

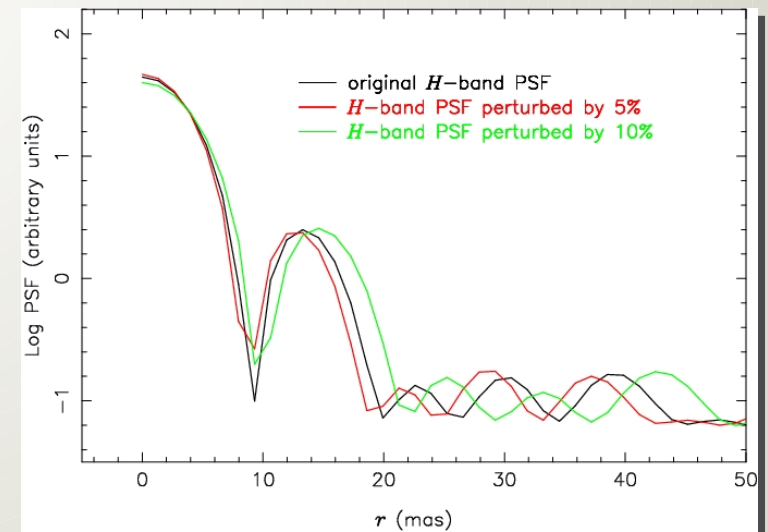

Effect of PSF errors

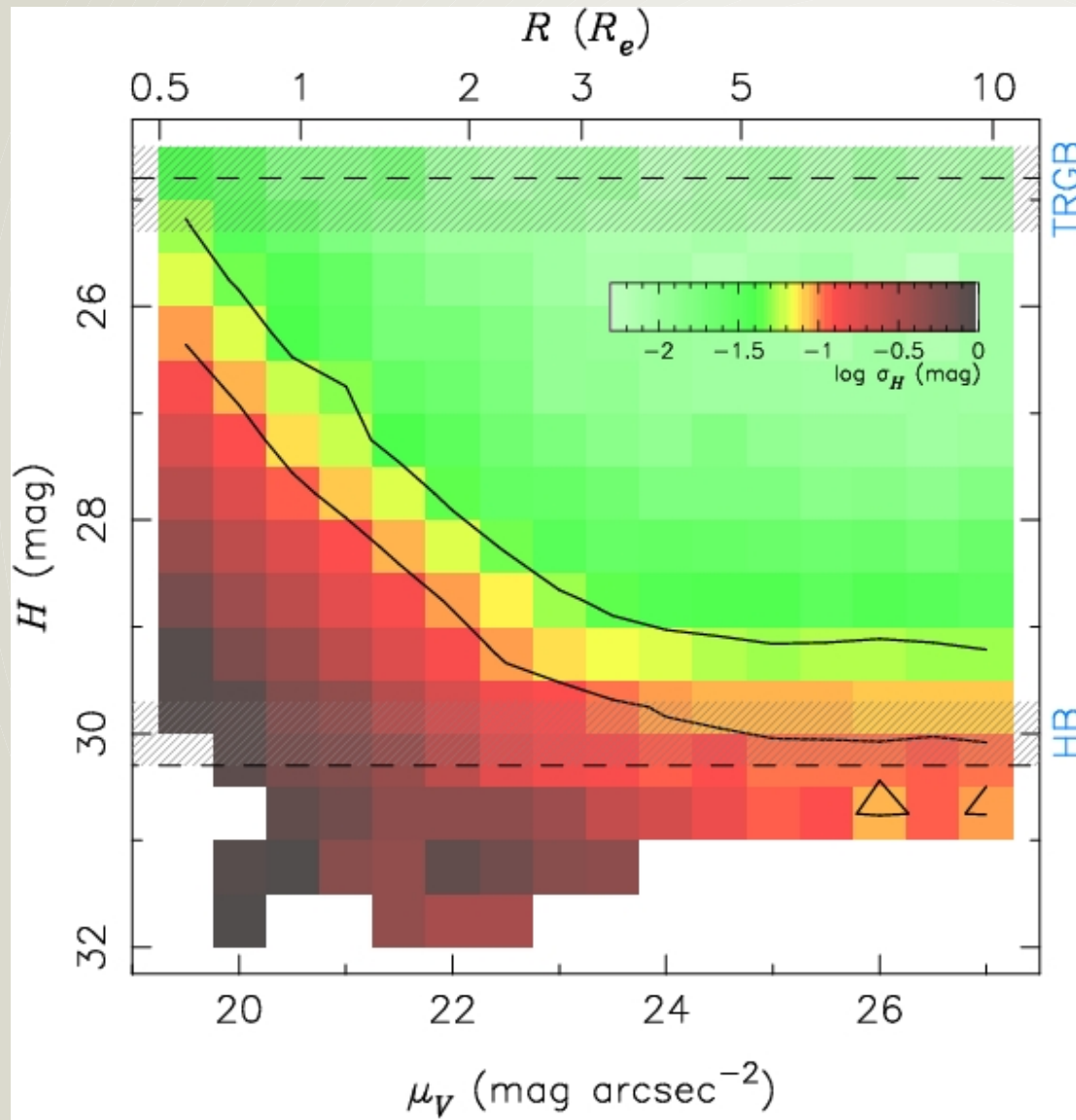

Using different PSFs for the image generation and analysis.

5% PSF “perturbation”

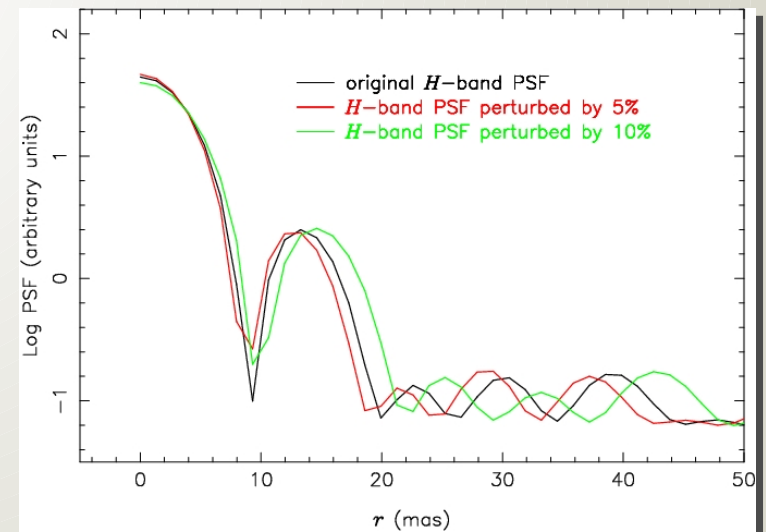

Effect of PSF errors

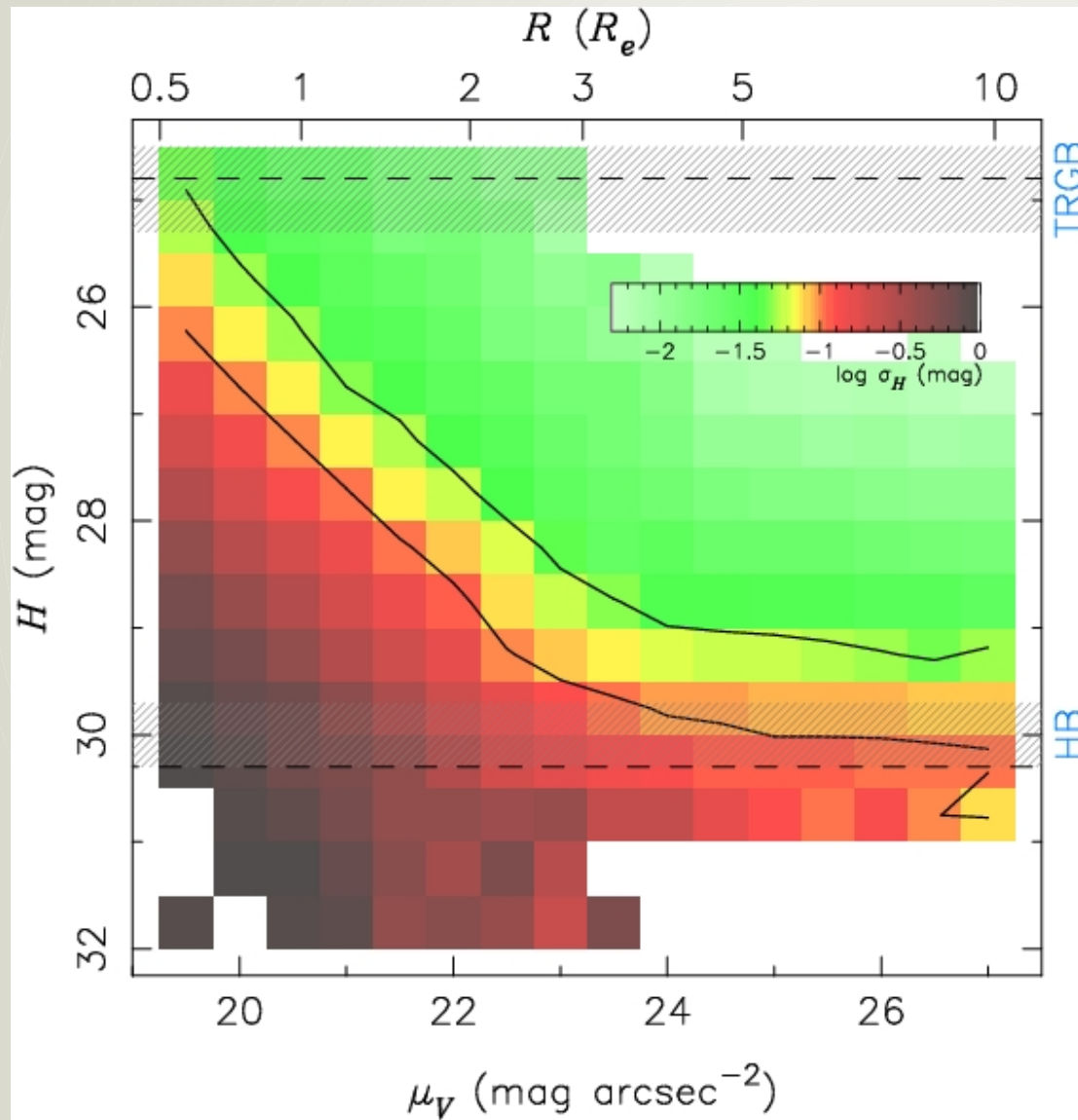

Using different PSFs for the image generation and analysis.

10% PSF “perturbation

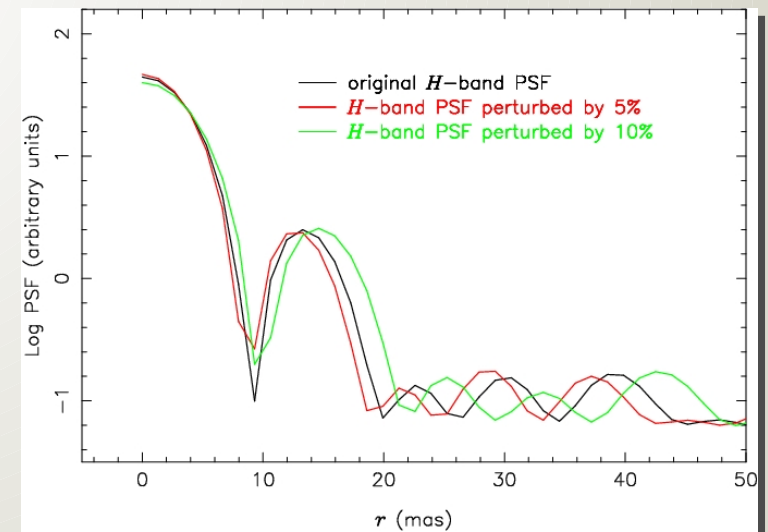

Effect of PSF errors

PSFs will vary as a function of:

- Position within the FoV
- Time
- Airmass
- Colour of the star
- ...

How will these variations be calibrated out?

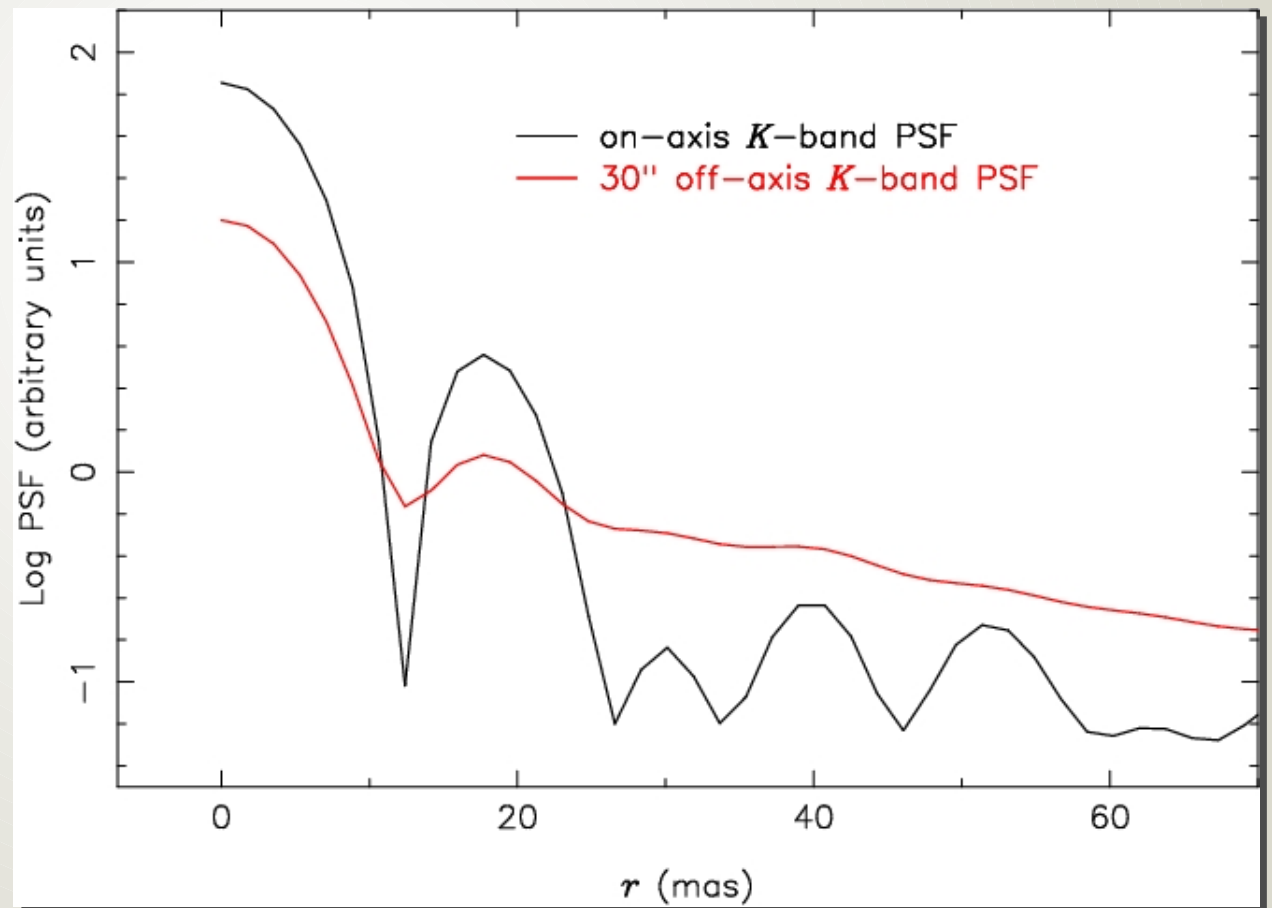

Summary

- For M87 in the Virgo cluster the E-ELT will be able to probe the TRGB with 0.05 mag accuracy all the way into the very dense central parts of the galaxy, down to $\sim 0.5 R_e$.
- The accuracy of the photometry in crowded stellar fields is entirely driven by resolution. It is independent of the quality of the AO correction as long as the correction is good enough to provide a reasonably well-developed diffraction-limited core in the PSF. Beyond this requirement the value of the Strehl ratio is immaterial.
- Given current AO predictions the above point will restrict RSP studies with the E-ELT to wavelengths $> 0.9 \mu\text{m}$.
- PSF variations will have to be tracked at a level of a few %.

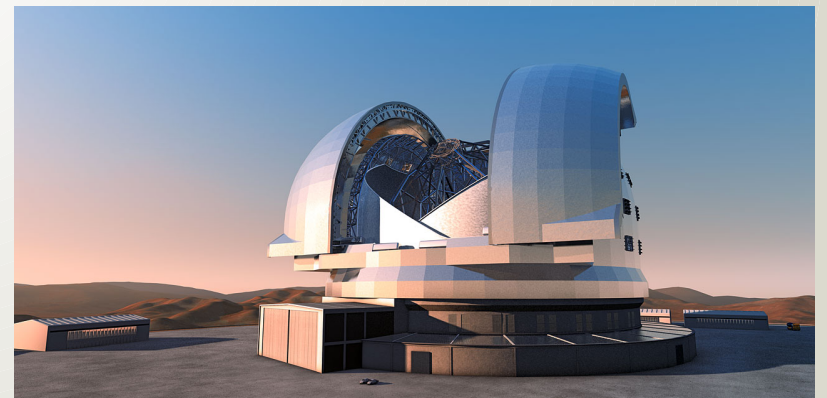

Summary

- For M87 in the Virgo cluster the E-ELT will be able to probe the TRGB with 0.05 mag accuracy all the way into the very dense central parts of the galaxy, down to $\sim 0.5 R_e$.
- The accuracy of the photometry in crowded stellar fields is entirely driven by resolution. It is independent of the quality of the AO correction as long as the correction is good enough to provide a reasonably well-developed diffraction-limited core in the PSF. Beyond this requirement the value of the Strehl ratio is immaterial.
- Given current AO predictions the above point will restrict RSP studies with the E-ELT to wavelengths $> 0.9 \mu\text{m}$.
- PSF variations will have to be tracked at a level of a few %.

http://www.eso.org/sci/facilities/eelt/science/doc/drm_report.pdf

