



# THE EUROPEAN ELT

## PHASE B STATUS

*Roberto Gilmozzi*  
*E-ELT Principal Investigator*





# THE EUROPEAN ELT

- **A project lead by ESO on behalf of 14 member states**
  - 42m adaptive telescope with segmented primary based on a 5-mirror design
- **Goal of Phase B**
  - Proposal for construction by 2010
- **Schedule:**
  - Detailed design phase until end 2010
  - Start of construction: 2011
  - First light: 2018
- **Cost**
  - Telescope + 1<sup>st</sup> gen instruments: ~ 950 million Euros
  - Operations (incl new instruments): ~ 35 M€/year
- **Resources**
  - 2007-2009: 57.2 M€ (including 110 FTEs)
  - 2008-2011: 5 M€ for E-ELT related R&D
  - Supporting activities from FP6 (28.8 M€) & FP7 (6.1 M€)





# PHASE B STATUS

- **Telescope design being consolidated**
  - BRDv2 → BRDv3 (Review 26-28 Nov 2008)
- **All major telescope subsystems have started their iteration through industrial suppliers**
  - Several reached preliminary design and are moving to next
  - FEED studies ongoing
- **All Phase A instrumentation studies ongoing**
  - 8 instruments, 2 post-focal AO modules
- **Operations scenarios being analyzed**
  - Observing modes
  - Logistics, maintenance, safety
  - Operations costs evaluated
- **Progress of DRM and DRSP**
- **Site Selection Advisory Committee**
  - Nominated to help us select the site
- **Project funding:** Council discussions, EIB contacts
- **Major upcoming reviews:** BRD (05/2009), construction (09/2010)





# HISTORICAL BACKGROUND

- Precursor (1977): 25m telescope ideas (Meinel et al)
  - ELTs as we conceive them today have been around since the late 80s, early 90s: **Swedish 25-m telescope**
  - mid 90s: **OWL 100-m & CELT 30-m**
  - Early 00s: **Euro-50, VLOT, GSMT, CELT, OWL, GMT**
  - In 2004 ESO Council resolved that:
    - *ESO's highest priority strategic goal must be the European retention of astronomical leadership and excellence into the era of Extremely Large Telescopes...*
    - *the construction of an Extremely Large Telescope on a competitive time scale will be addressed by radical strategic planning, especially with respect to the development of enabling technologies and the exploration of all options, including seeking additional funds, for fast implementation*
-  ***ELT effort re-oriented at the end of 2005 towards “the best affordable ELT Facility that can be built on a competitive timescale and with acceptable risks”***
- Mid 00s: **consolidation to E-ELT, TMT & GMT**





# GUIDELINES

## Affordable

- **Cost ~ VLT, ALMA**

## Timely

- **JWST ( $\geq 2013$ ) synergy, competitors**

 **First science ~ 2018**

## Acceptable risk

- **No essential items R&D on critical path**
- ***Upgrade paths* where appropriate**

# SYNERGIES

- The 8-10m class Telescopes (VLT/I, ...)
- The JWST
- **ALMA**
- LSST/Surveys
- SKA / SKA Pathfinders
- ...

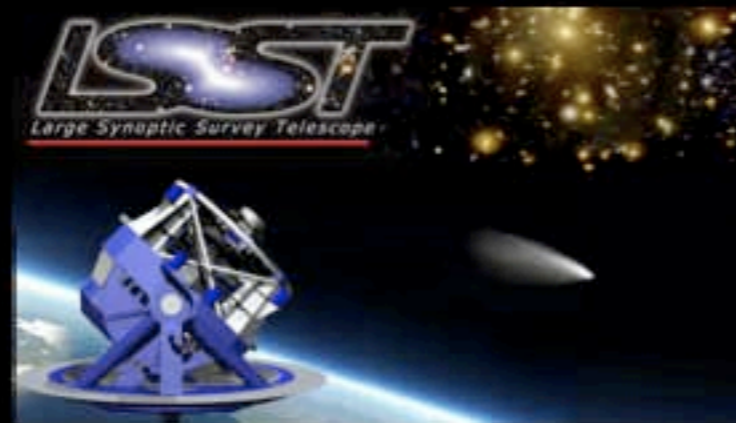





# EELT BACKGROUND

- **November 2005:** OWL review concluded that although technically feasible the concept was too risky to conclude on a competitive timescale. The review board recommended that the project advance to phase B but to review high risk areas before doing so
- **January 2006 to April 2006:** The ESO DG called upon the community to establish 5 working groups to create a tool box for the EELT evolution.
- **April 2006 to December 2006:** ESO together with industrial and community support established a new baseline reference design for a 42-m European ELT.
- The design was blessed by the ELT Science & Engineering subcommittee of the ESO STC, the STC, the ESRC & the ESO community at the Marseille meeting.
- The ESO Council launched the phase B detailed design phase of the project in **December 2006** with a three year timeline and a budget of 57.2 Million Euro.





# THE DRIVER

- **Planets in other stellar systems**
  - Imaging *and* spectroscopy
  - The quest for Earth-like exo-planets
- **Stellar populations**
  - In galaxies inaccessible today (e.g. ellipticals in Virgo cluster)
  - Across the whole history (i.e. extent) of the Universe
- **Cosmology**
  - The first stars/galaxies
  - Direct measure of deceleration
  - Evolution of cosmic parameters
  - Dark matter, dark energy
- **The unknown**
  - Open new parameter space

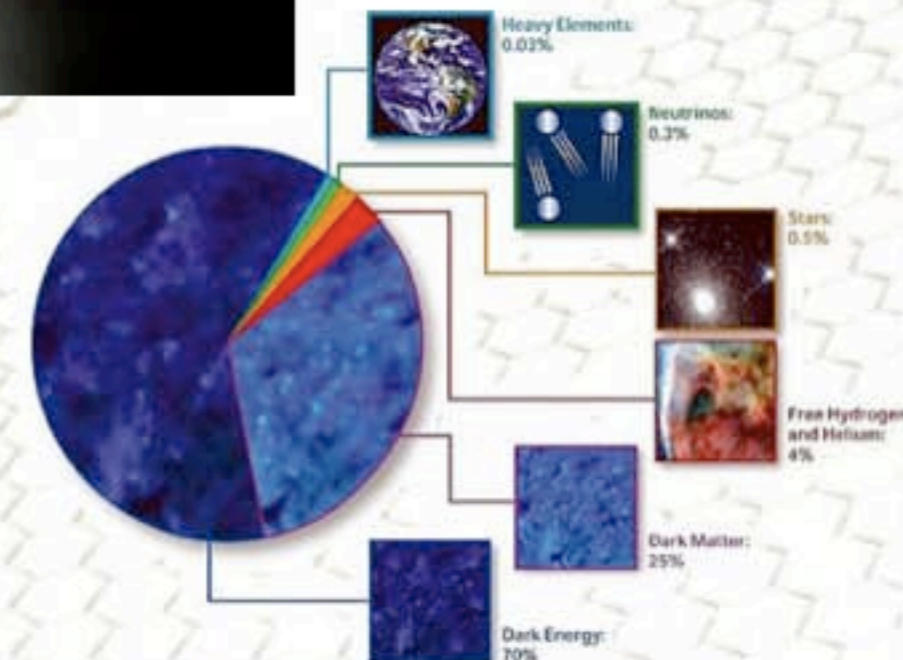
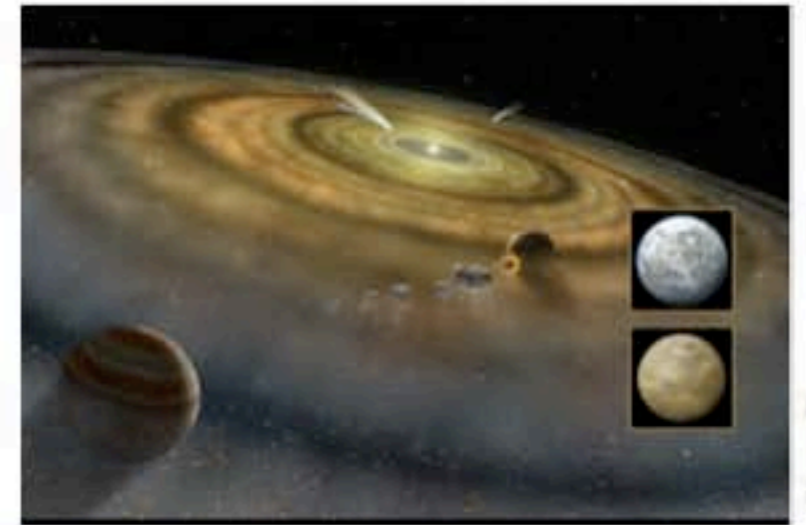





# SENSITIVITY EVOLUTION

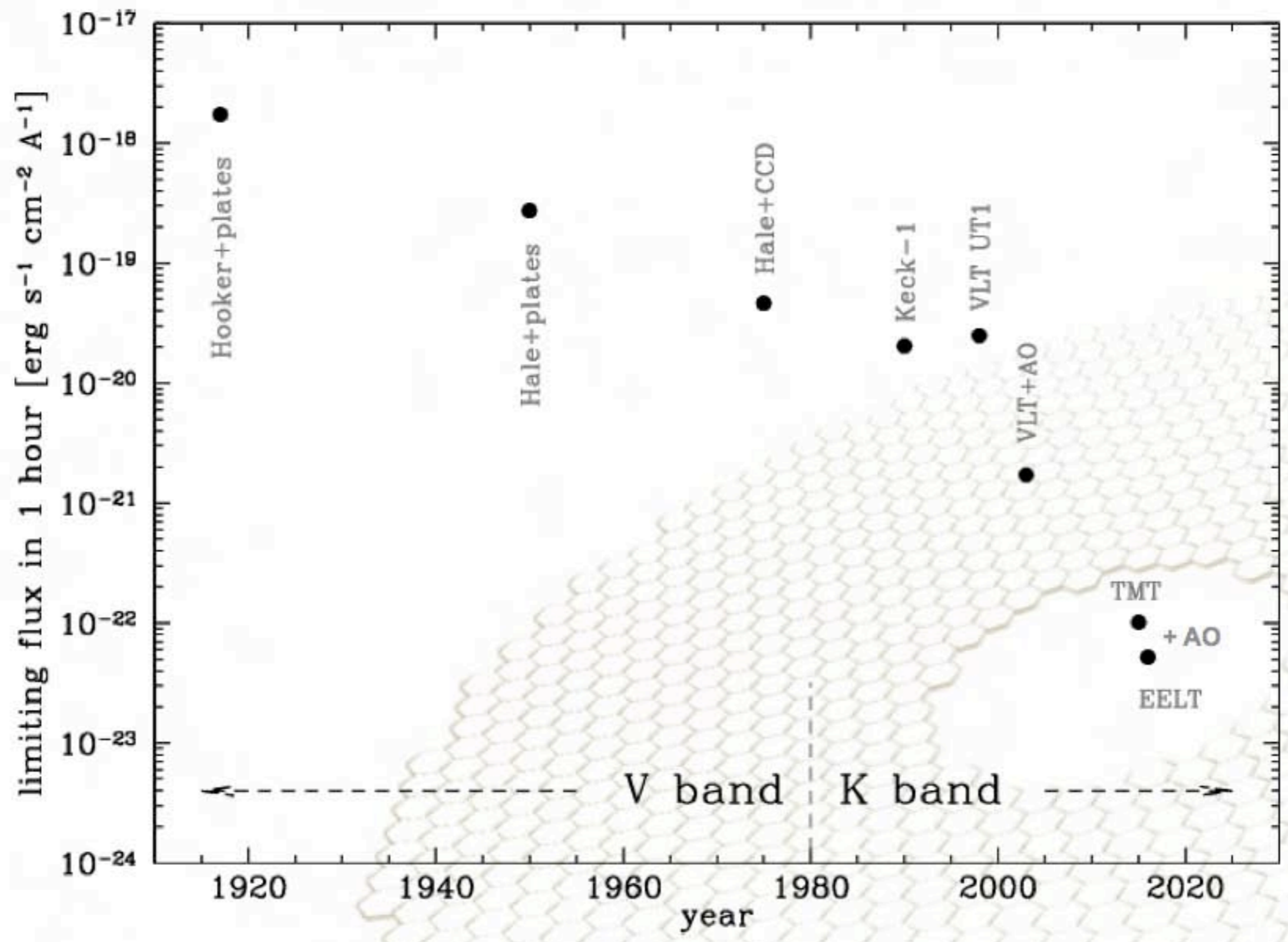



# HIGH SPATIAL RESOLUTION

1 arcsecond

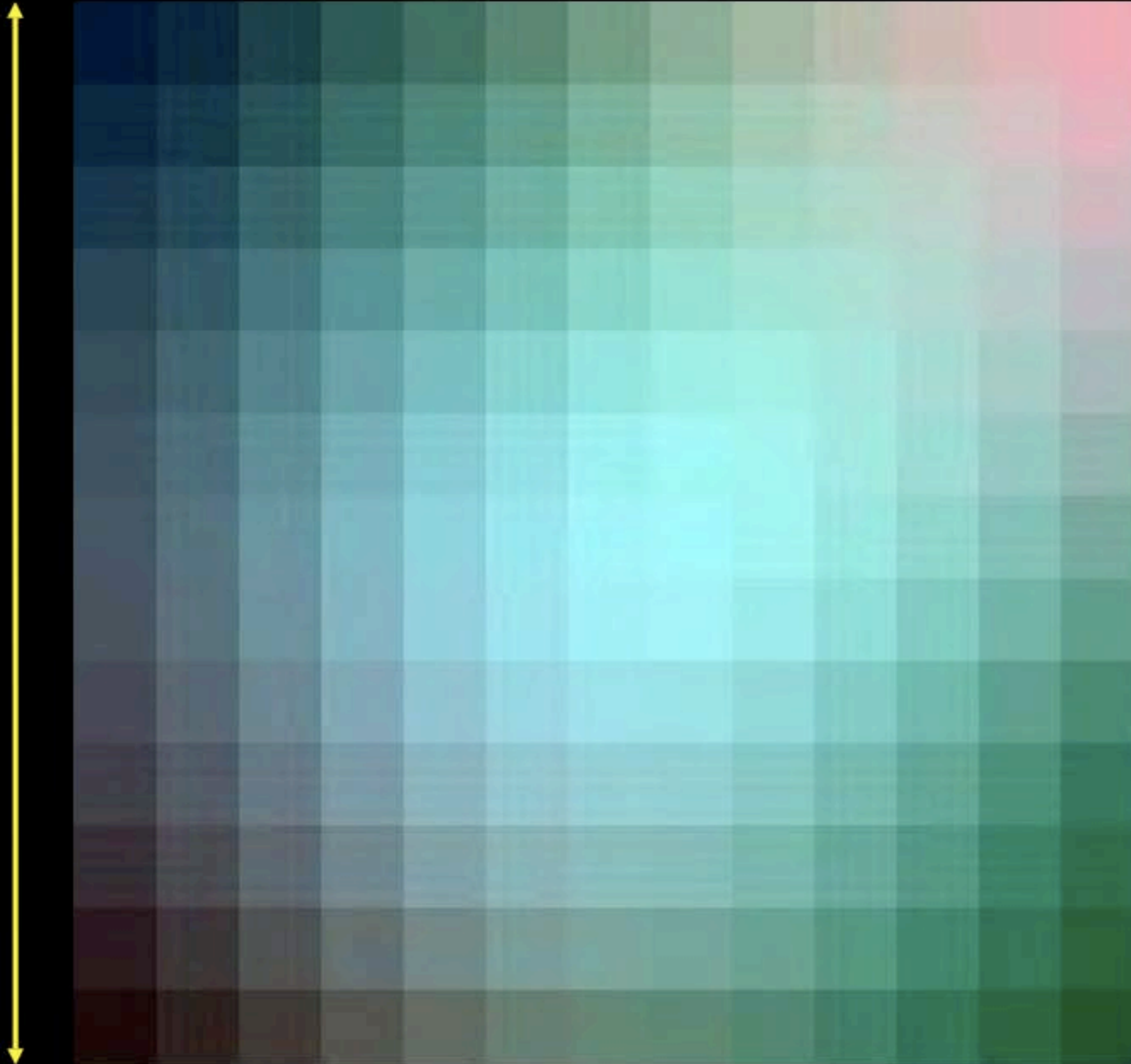

Seeing  
limited



# HIGH SPATIAL RESOLUTION

1 arcsecond

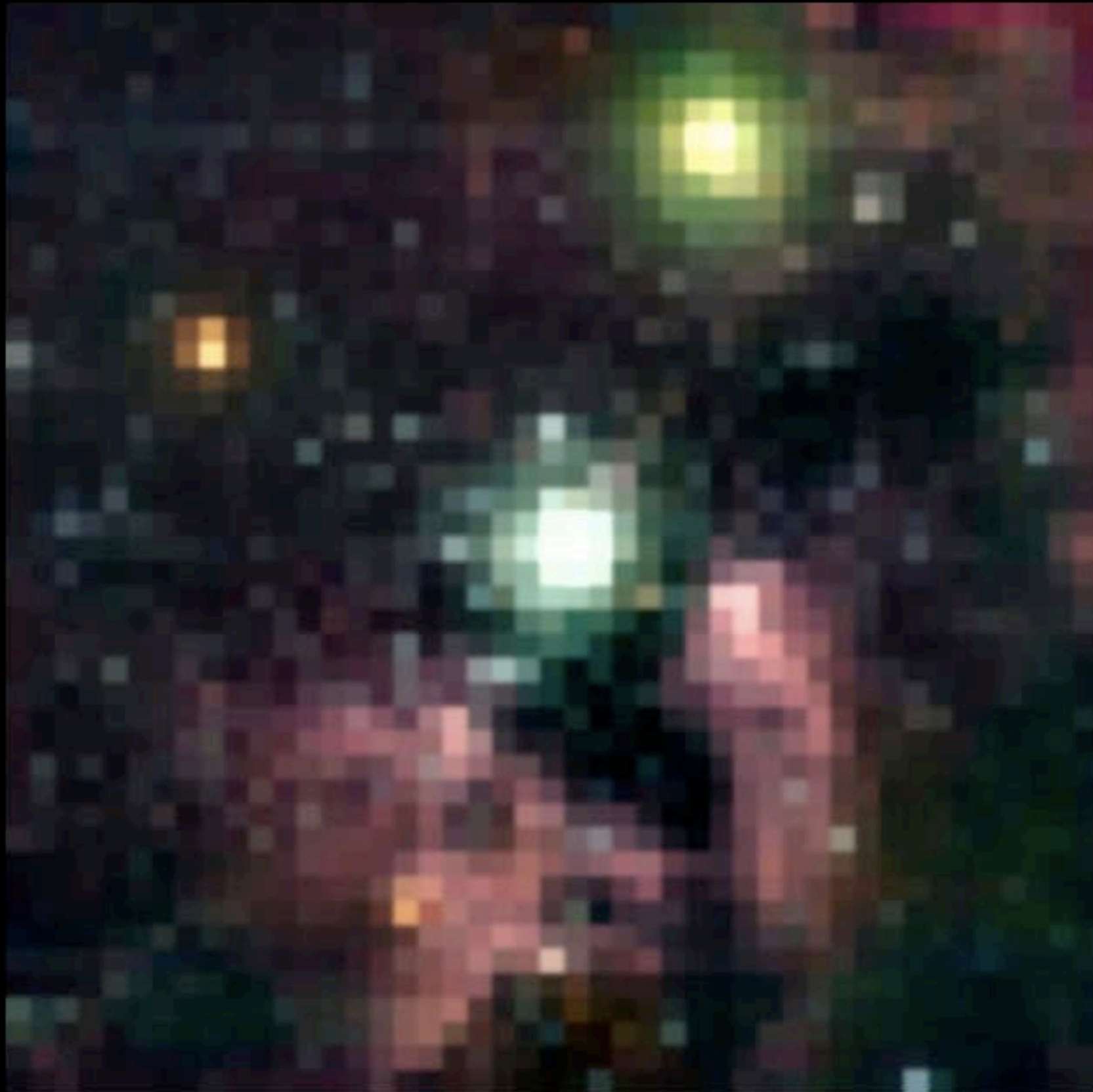

HST



# HIGH SPATIAL RESOLUTION

1 arcsecond



VLT+AO



# HIGH SPATIAL RESOLUTION

1 arcsecond



E-ELT





# AN AO MILESTONE: MAD

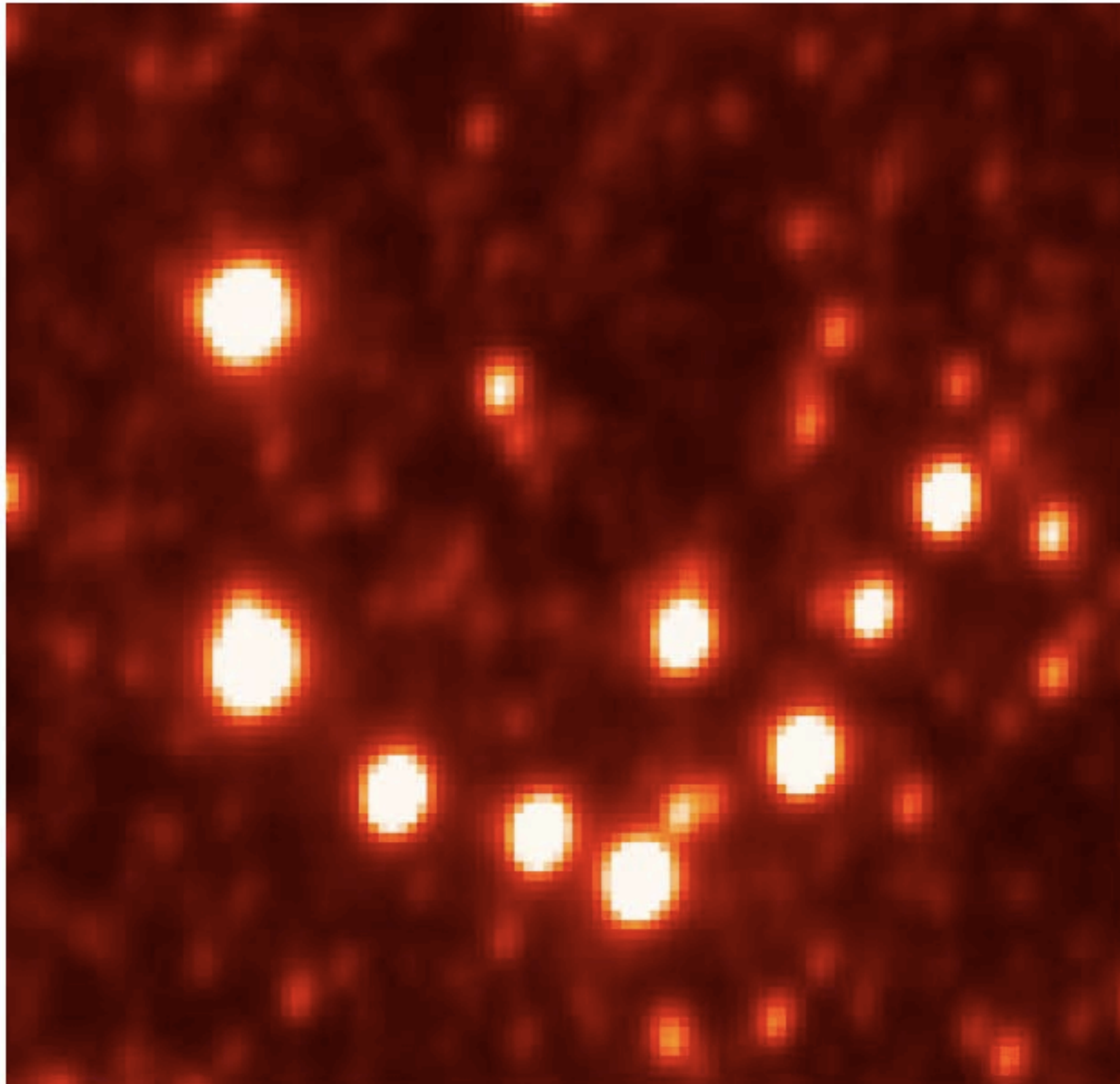

Field: 15x15"

MCAO:

- Guide stars at 2'
- K-band
- FWHM: 100-120mas
- Sr: >20%
- 0.7" seeing
- Exposure 360 s

ISAAC seeing: ~ 0.5"

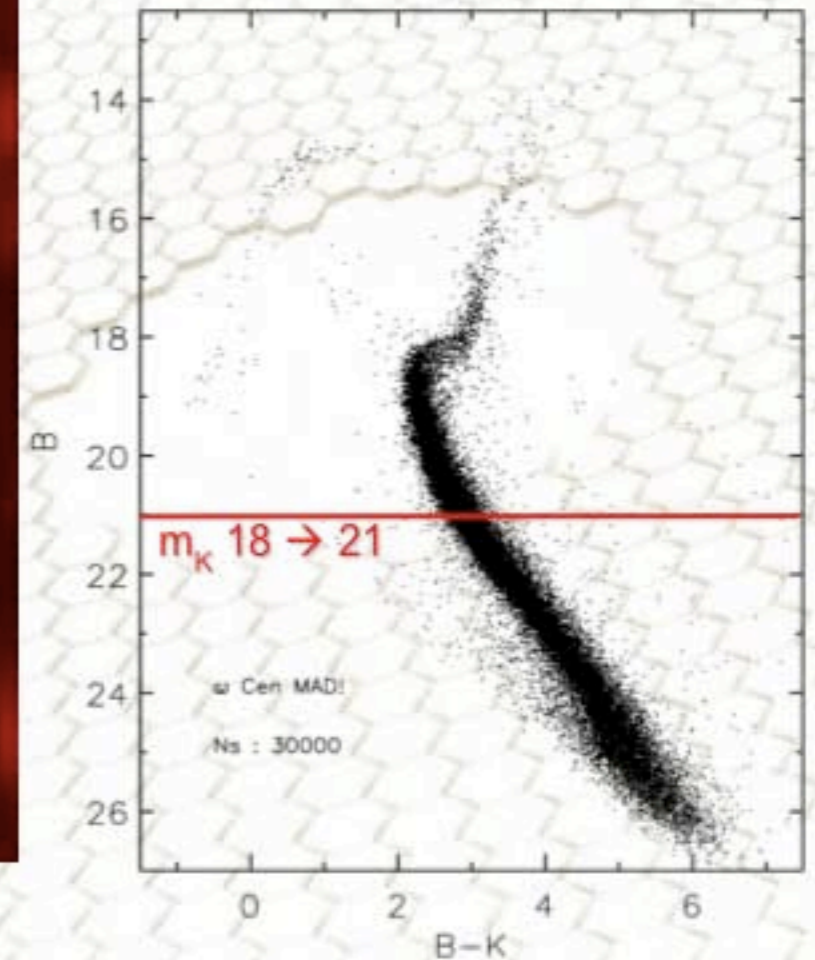





# AN AO MILESTONE: MAD

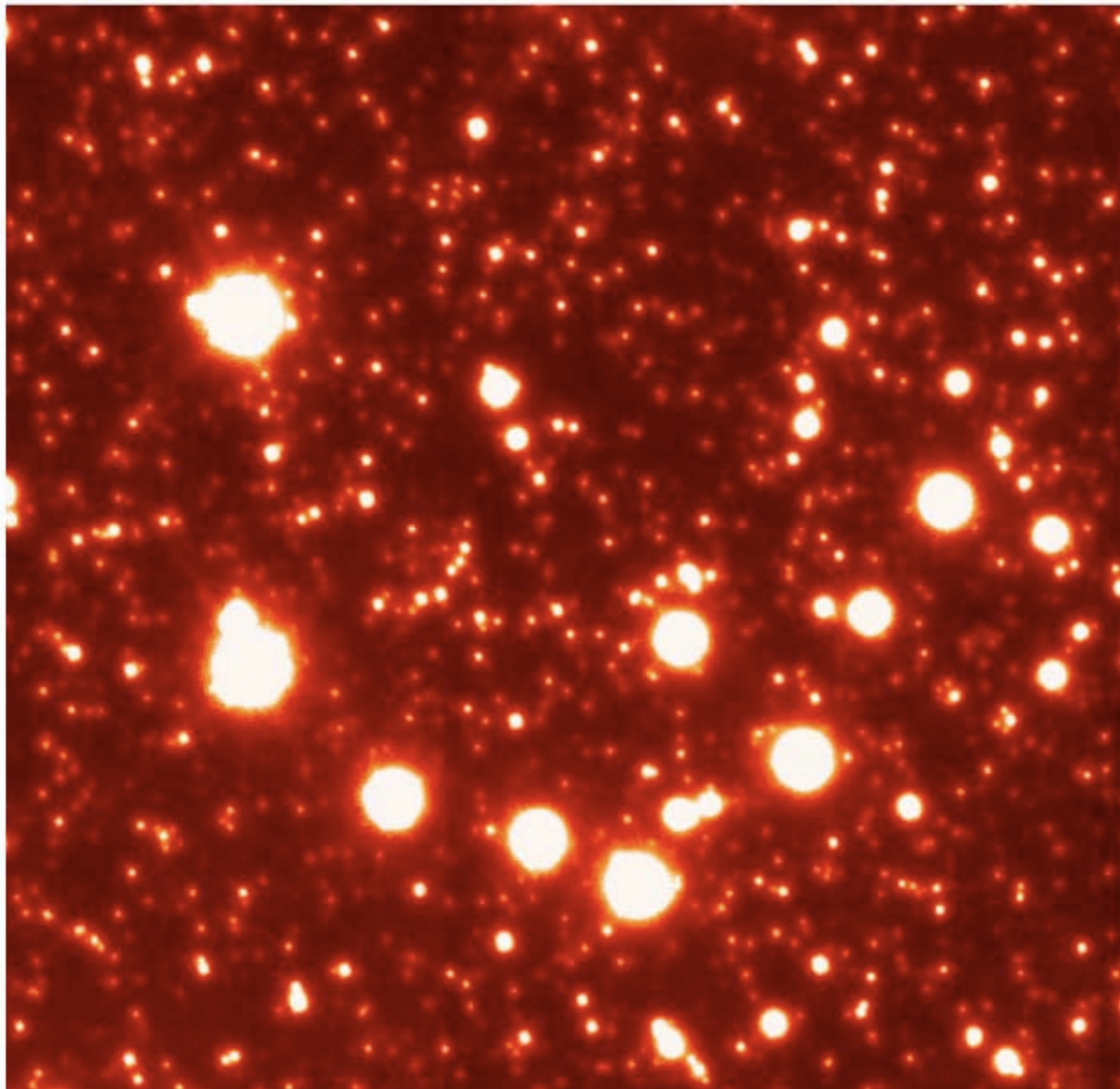

Field: 15x15"

MCAO:

- Guide stars at 2'
- K-band
- FWHM: 100-120mas
- Sr: >20%
- 0.7" seeing
- Exposure 360 s

ISAAC seeing: ~ 0.5"

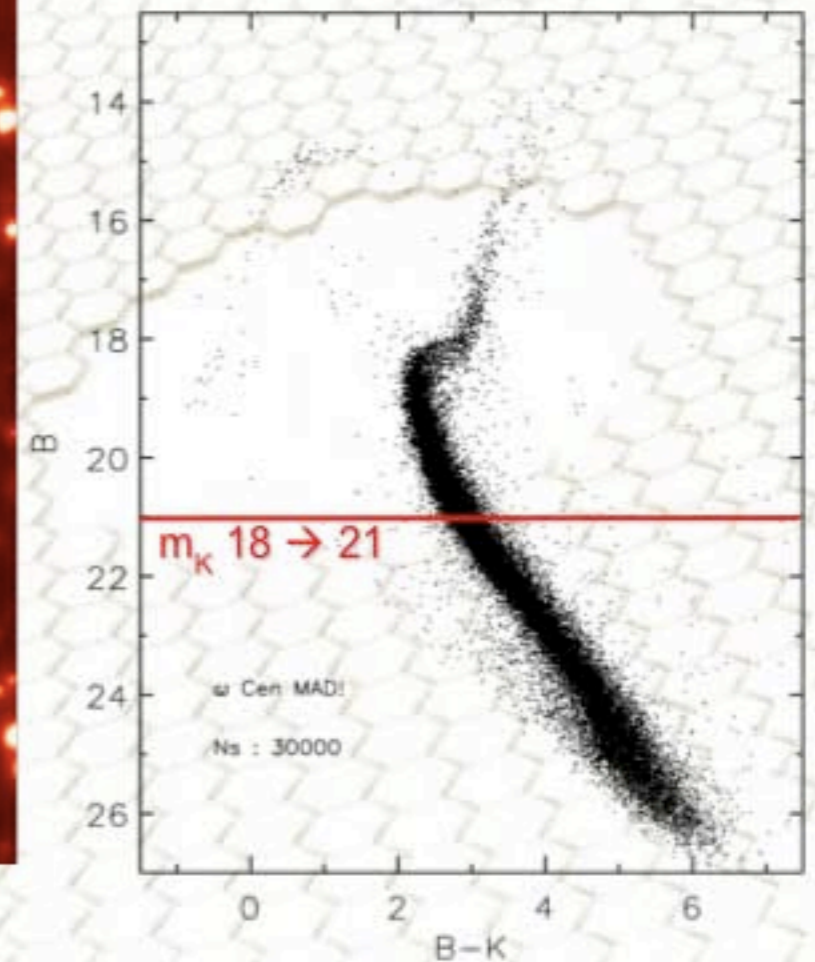





# ELT SCIENCE CASE DEVELOPMENT IN EUROPE



Florence  
2004

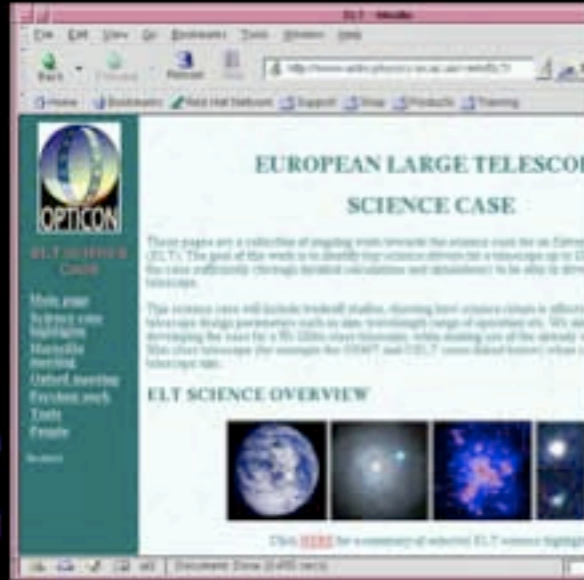

Web  
site

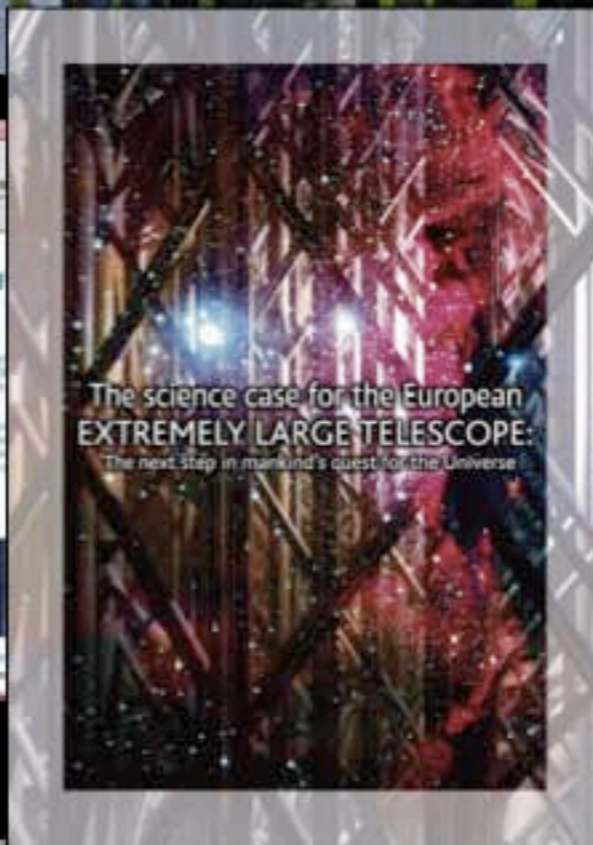

Marseilles 2003

Science case  
documents

Marseilles 2006







# DRM CASES

Input from: Community, SWG  
Simulations: EScO, Community

## Planets & Stars

- \* S3: From giant to terrestrial exo-planets: detection, characterisation and evolution (demo case)
  - 1- Direct imaging of terrestrial and giant exo-planets
  - 2- Detection of New Earths
  - 3- Rocky planets in the habitable zones of low-mass stars and brown dwarfs
  - 4- Physical properties of Earth-sized planets
- \* S9: Circumstellar disks
  - 1- Imaging the planet-forming regions of circumstellar disks
  - 2- Dynamics and chemical evolution of circumstellar disks
- \* S5: Young stellar clusters and the Initial Mass Function
  - 1- Characterising the lowest mass freely floating objects
  - 2- The Centres of Massive Dense Young Clusters: deep ELT infrared imaging and 3D spectroscopy
  - 3- The low-mass Initial Mass Function in the Magellanic Clouds
  - 4- Giant-planet-mass objects in the Large Magellanic Cloud

## Stars & Galaxies

- \* G4: Imaging and spectroscopy of resolved stellar populations in galaxies (demo case)
  - 1- The Resolved Stellar Populations of Elliptical Galaxies
  - 2- The Chemo-Dynamical Structure of Galaxies
  - 3- First Stars relics in the Milky-Way and satellites
- \* G9: Black holes and AGN
  - 1- A Survey of Black Holes in Different Environments
  - 2- High precision dynamics of black hole/star binaries: a test of General Relativity

## Galaxies & Cosmology

- \* C10: The physics of high redshift galaxies (demo case)
  - 1- The Physics and Mass Assembly of Galaxies out to  $z=6$
  - 2- High resolution imaging of high redshift galaxies
  - 3- ELT integrated spectroscopy of early-type galaxies at  $z > 1$
- \* C4: First light - the highest redshift galaxies
  - 1- The highest redshift galaxies at  $z > 6$
- \* C7: Is the low-density intergalactic medium metal enriched?
  - 1- Is the low density IGM at  $z=2-3$  metal-enriched?
- \* C2: A dynamical measurement of the expansion history of the Universe
  - 1- Monitoring the redshift drift of the Lyman-forest, a direct measurement of the dynamical evolution of the Universe





# EXOPLANET DETECTION

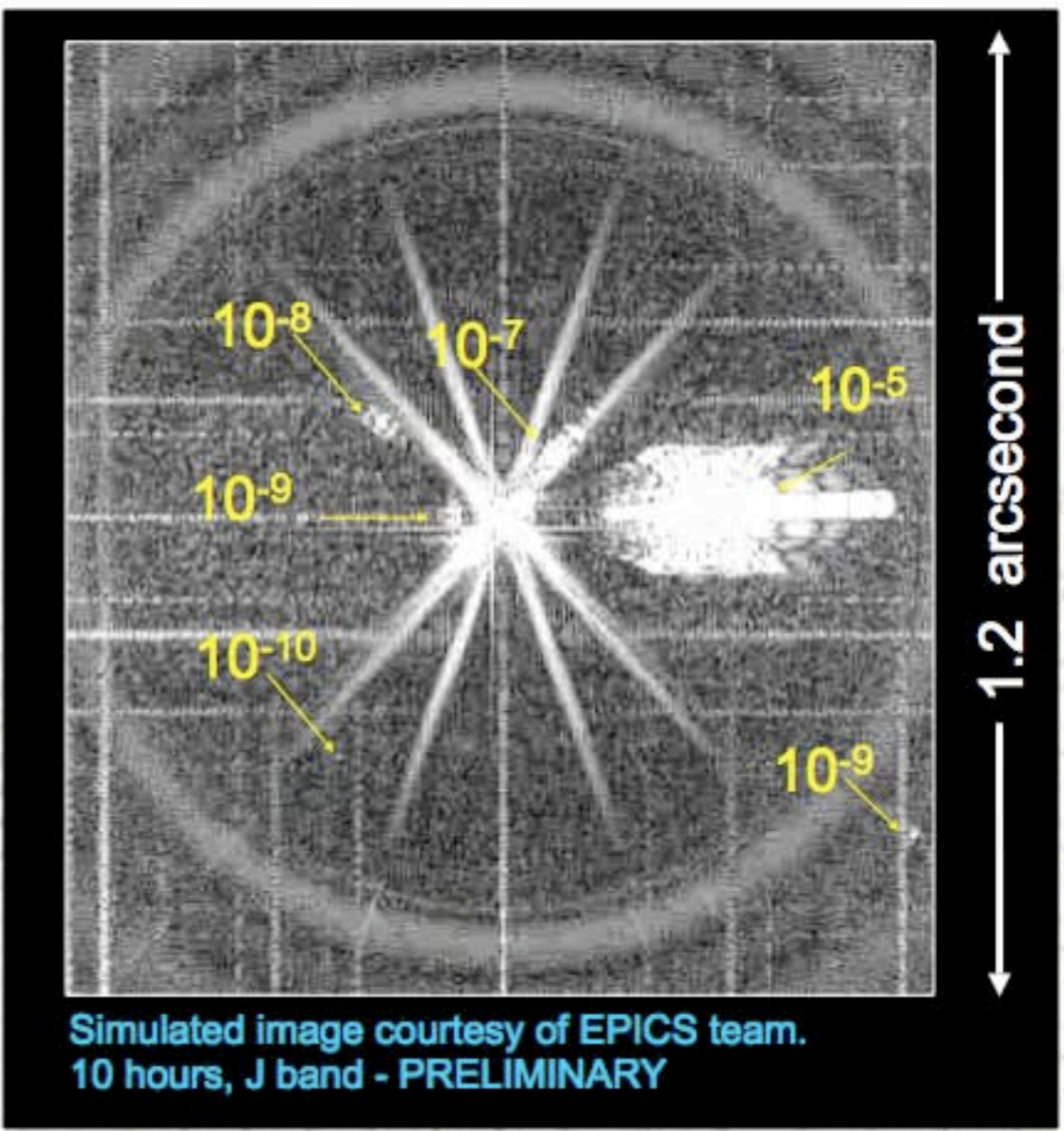
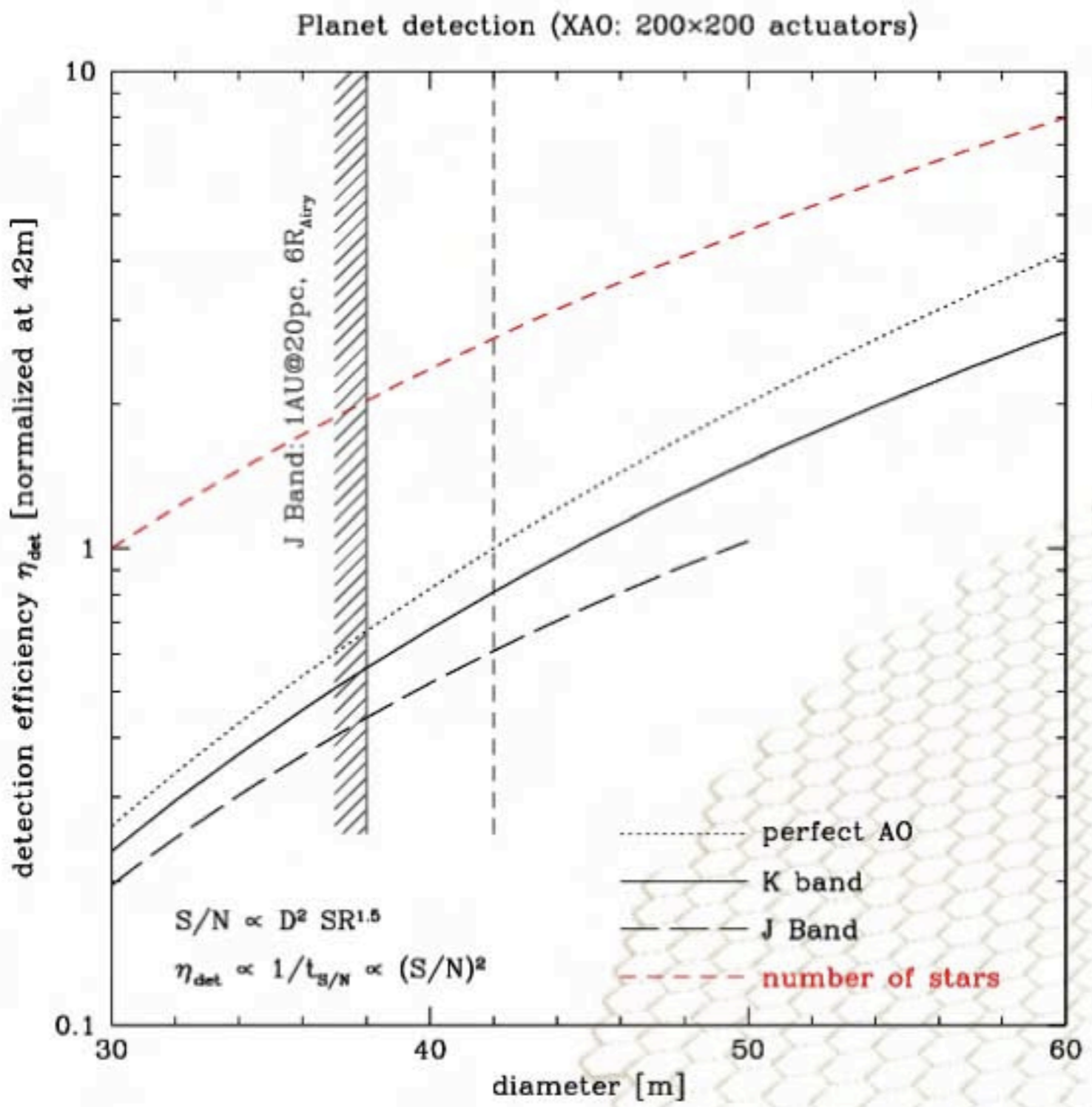





# THE SIMULATIONS

Example:  
Stellar population  
of a galaxy  
in a nearby galaxy cluster

I-band

10 hours

3x3 arcsec<sup>2</sup>

DM = 31.2

$\mu = 23 \text{ mag/arcsec}^2$

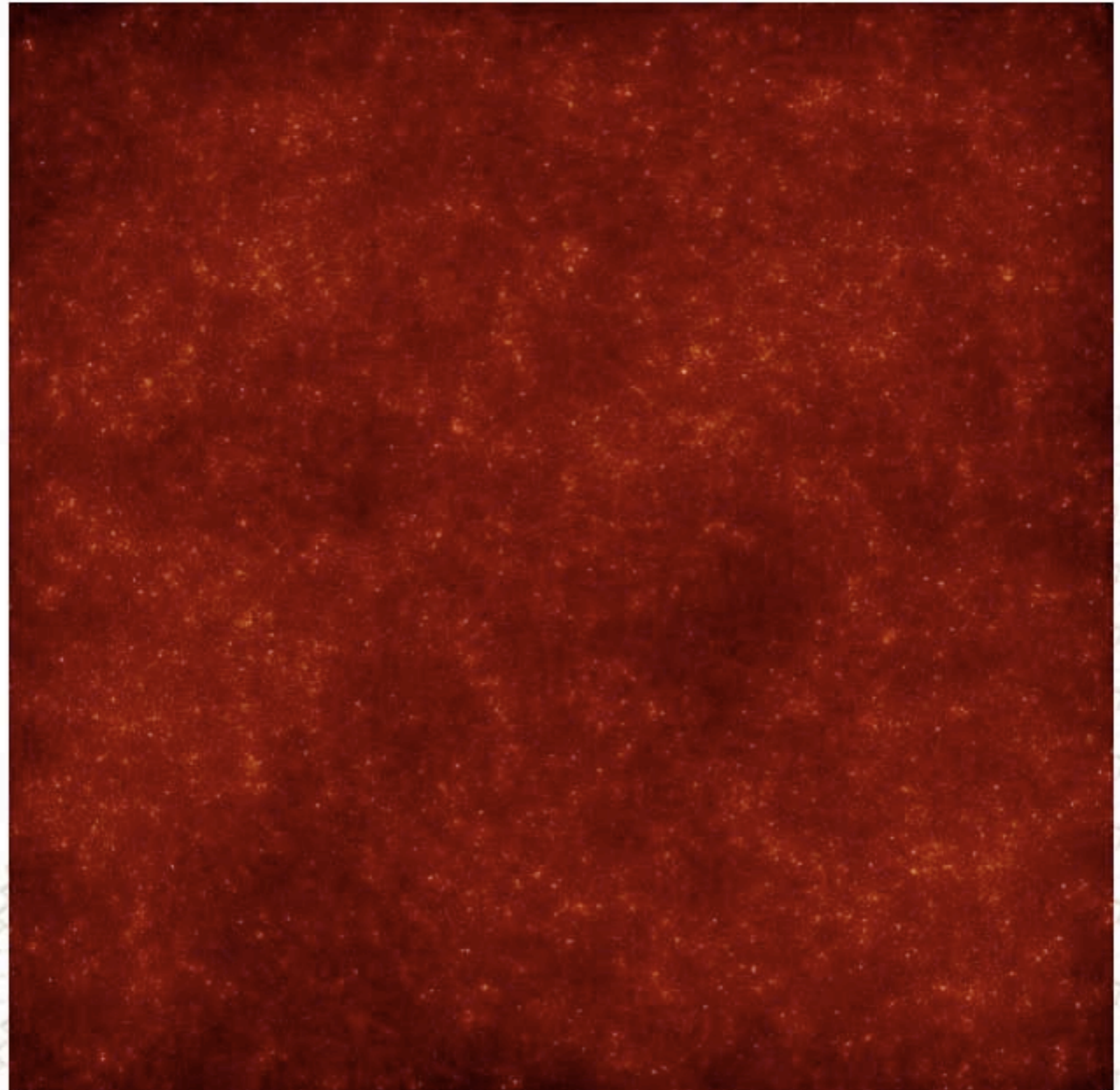
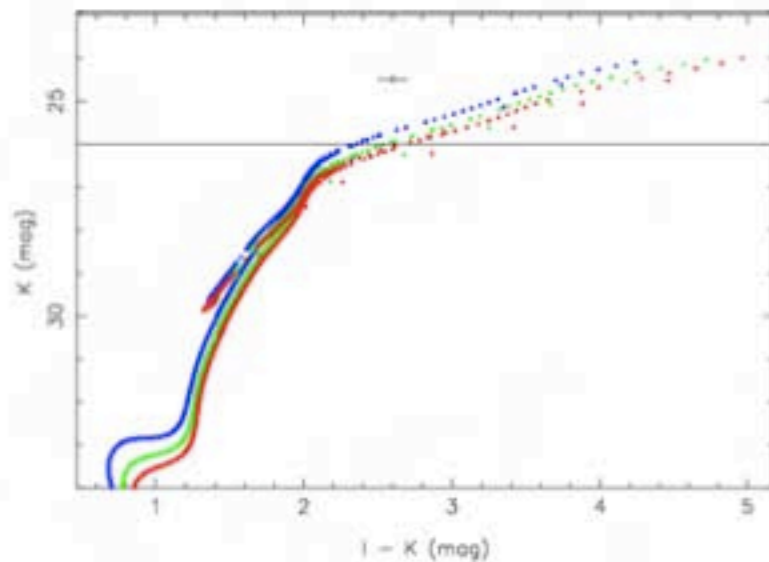



M87 (DM = 31.2)

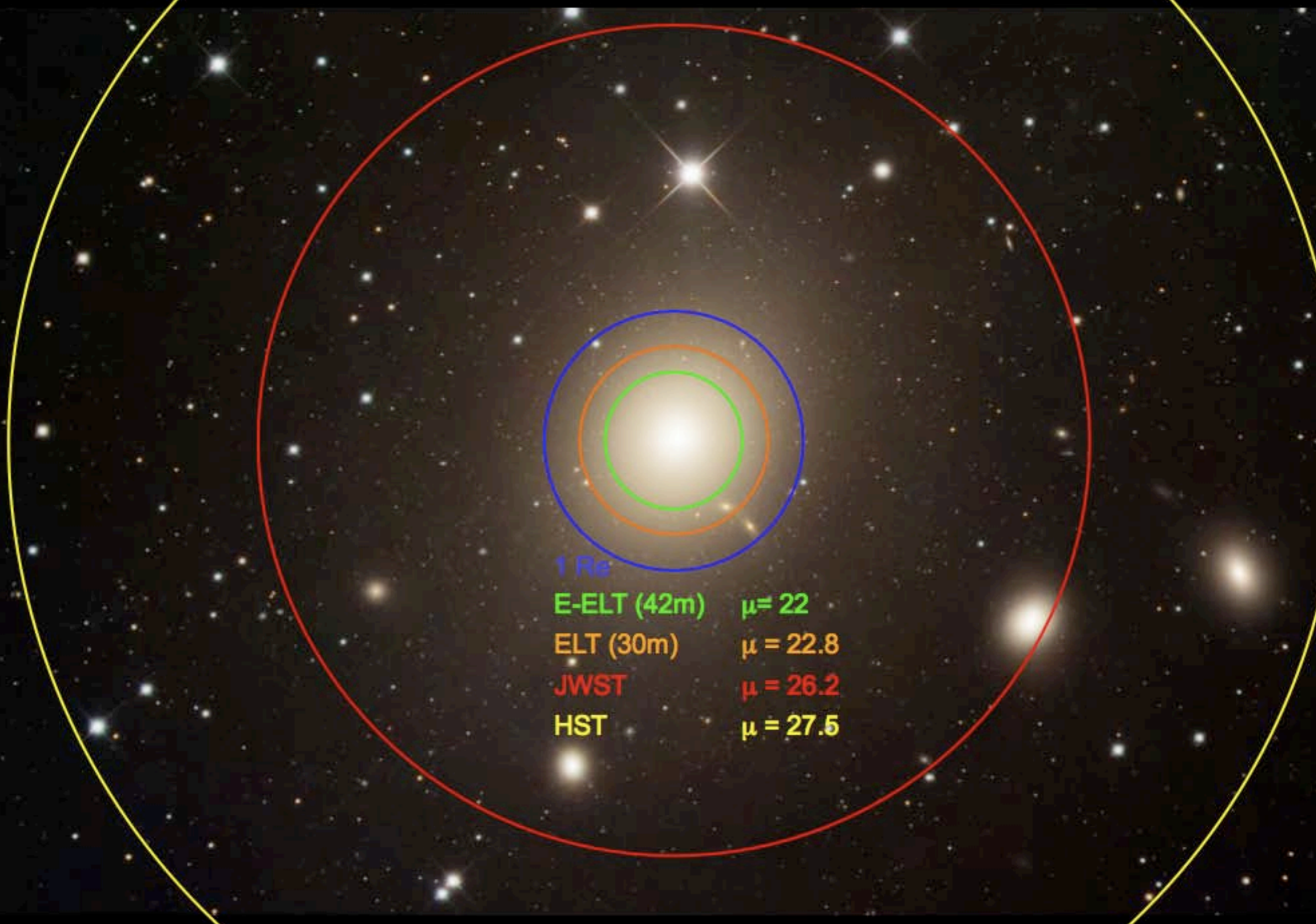

1 Re	
E-ELT (42m)	$\mu = 22$
ELT (30m)	$\mu = 22.8$
JWST	$\mu = 26.2$
HST	$\mu = 27.5$





# SUMMARY: POWERFUL PERFORMANCE

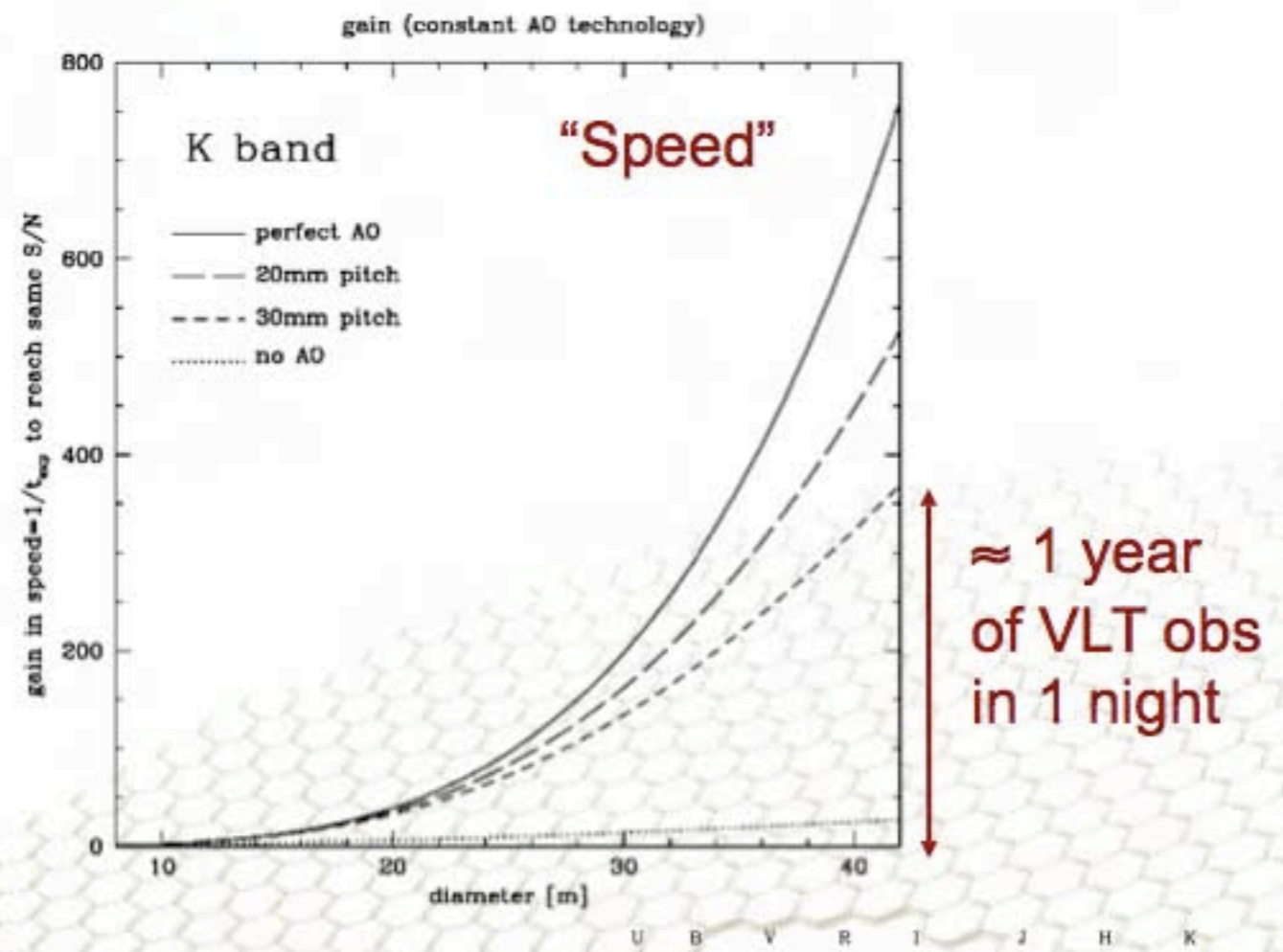
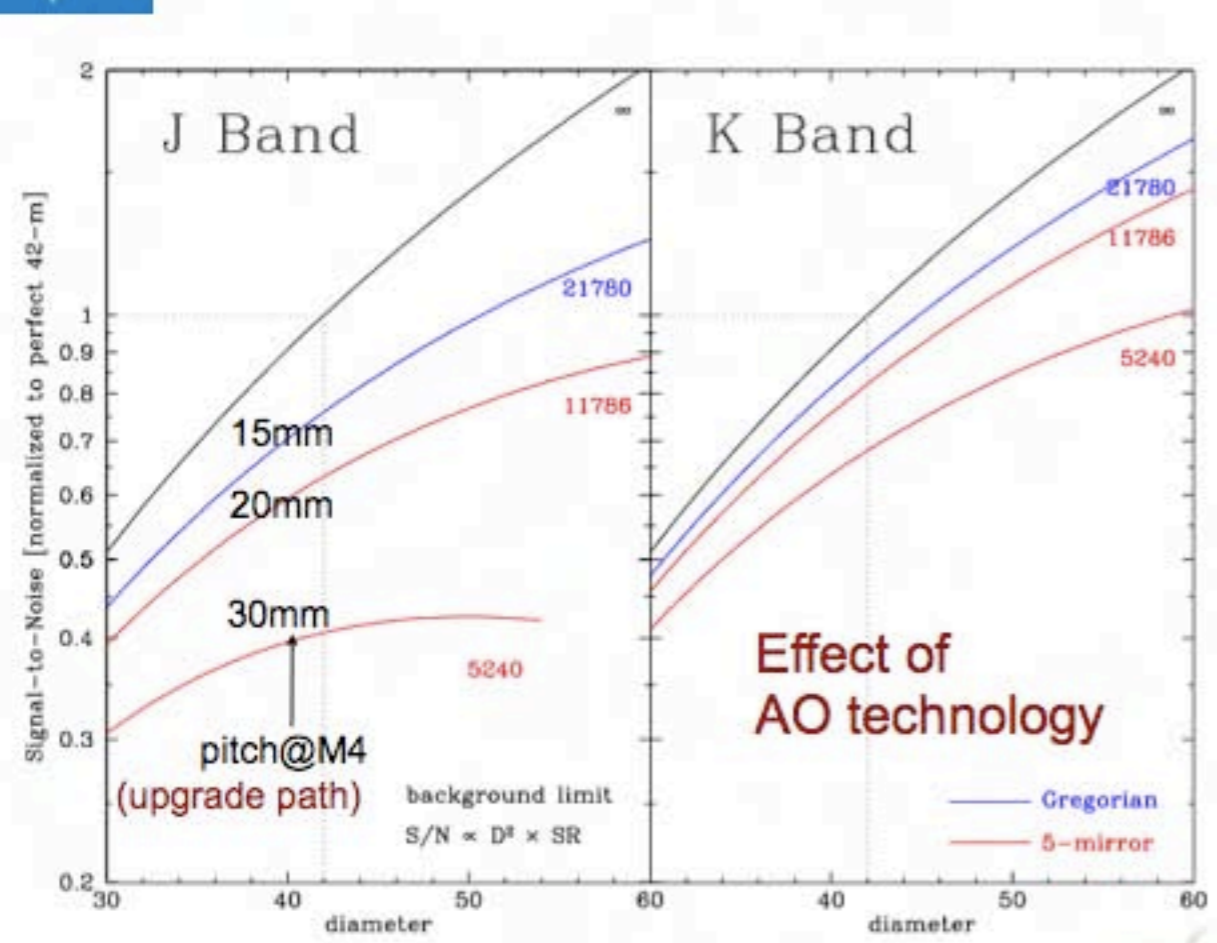

**$S/N = F / \sqrt{(F+B+\dots)}$**

Flux:  $F = F_0 \times SR \propto D^2 \times SR$   
 Bgd:  $B = sky \times pix^2 \propto D^2 \times D^{-2} \equiv B_0$

For faint sources:  
 **$S/N \approx F/\sqrt{B} \propto D^2 \times SR$**

For exo-planets:  
 **$S/N \approx F/\sqrt{B_{\star}} \propto D^2 \times SR^{3/2}$**

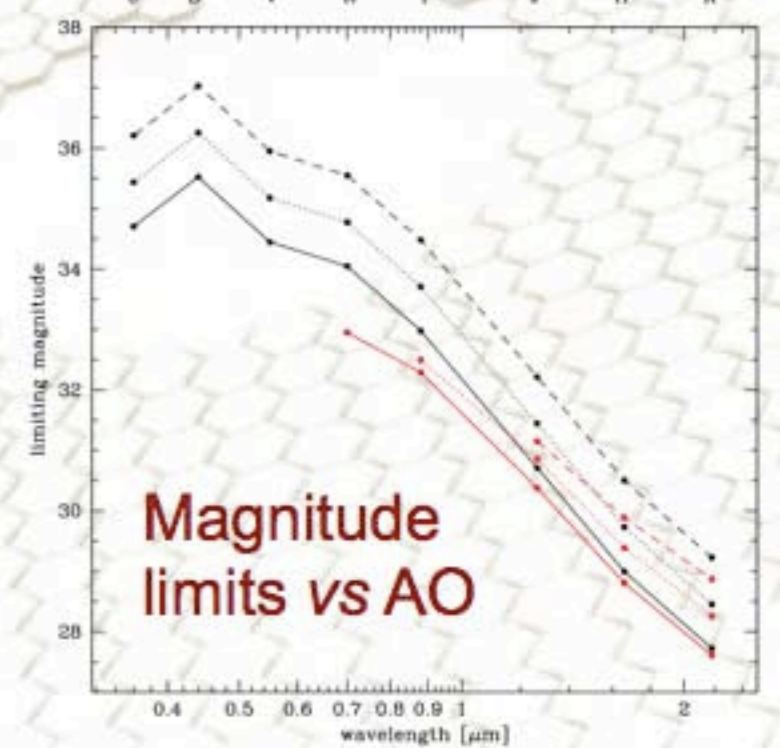
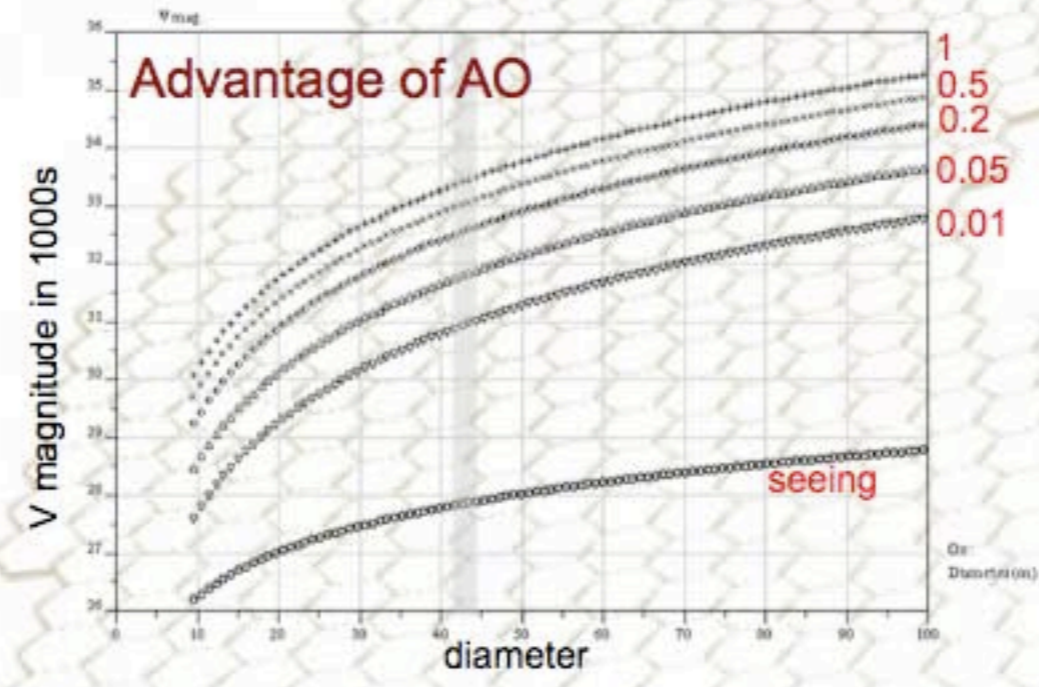





# STATUS OF THE DESIGN







# PROGRAMME ORGANIZATION

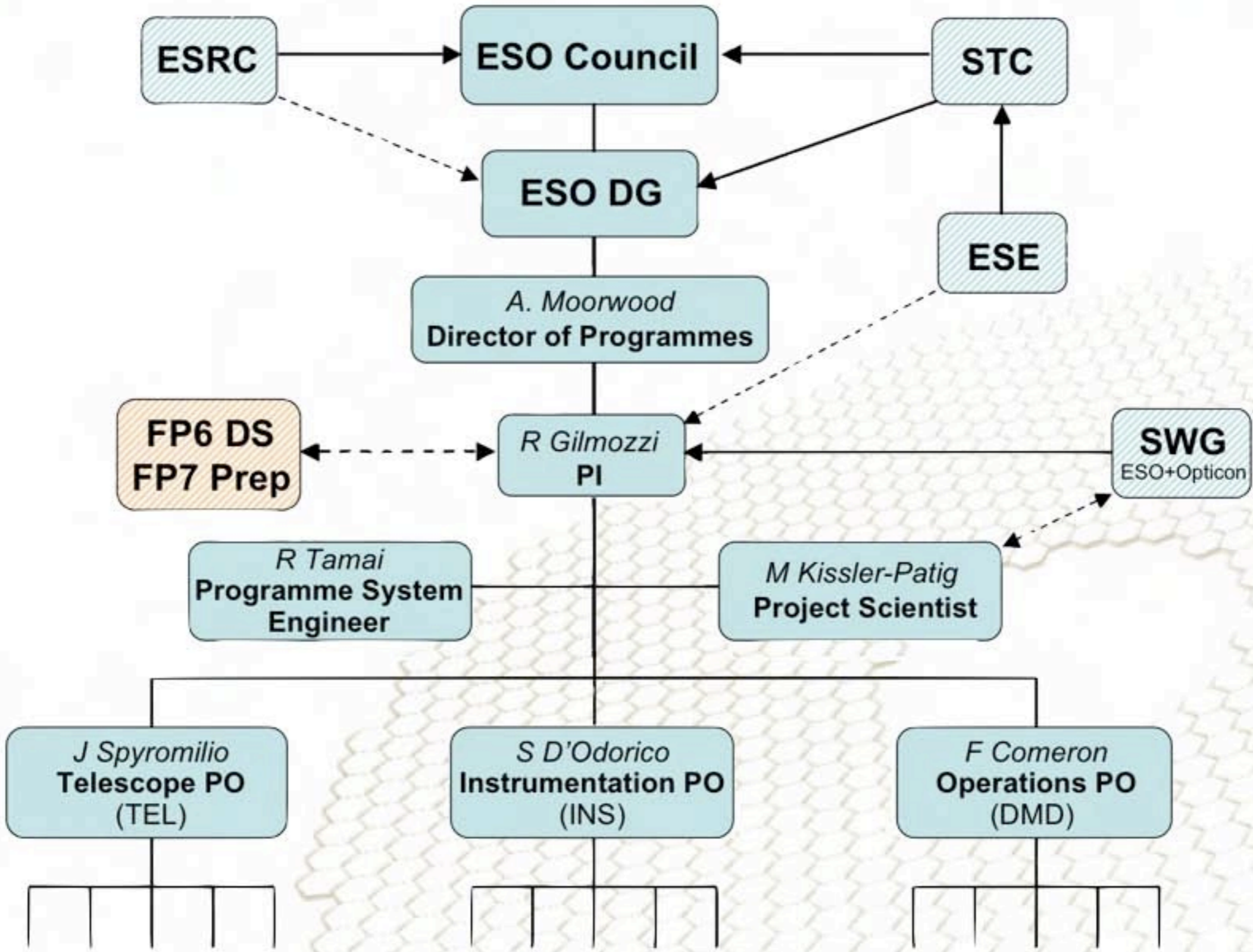





# THE FP INITIATIVES

- **FP6: ELT DS**

**Foster industrial and academic readiness to build an**

**Extremely Large Telescope**

➔ **Originally design independent**

**Realigned to the EELT specs after EELT BRD endorsed by ESO's committees and the wider community (Dec 2006)**

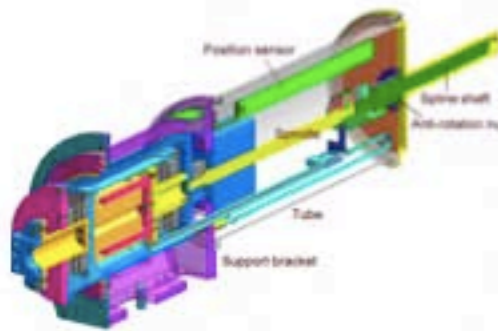

Metrology

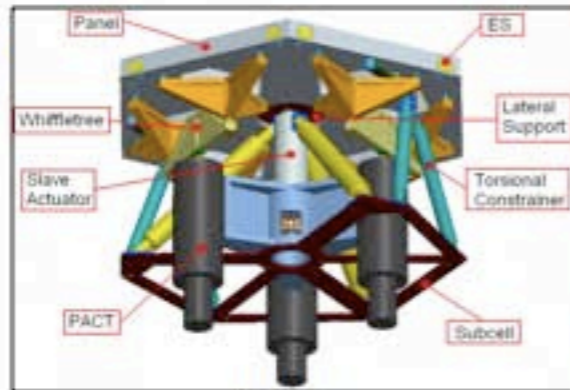

WEB

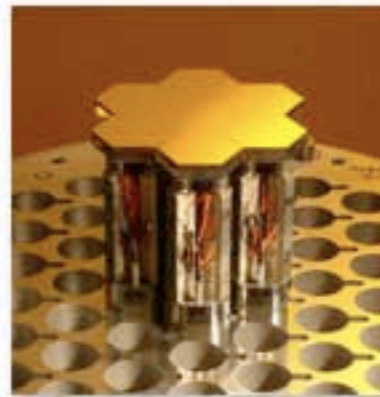

APE



Friction drive BB

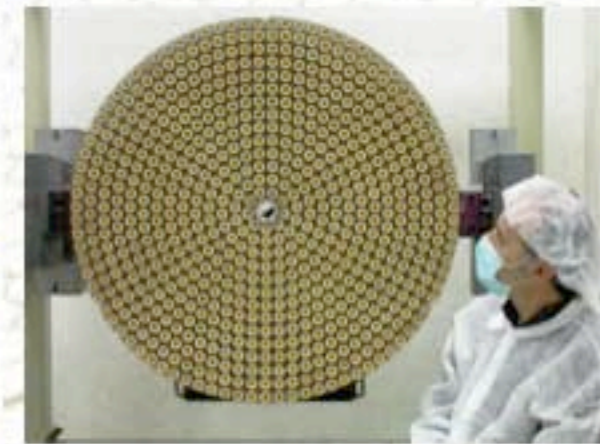

Large DMs

- **FP7: EELT Prep**

**Support preparedness to start construction phase**

**Funding scenarios, expanded partnership, international cooperation, centers of excellence, science access**

*Design Reference Mission*

*Upgrade paths*





# THE TELESCOPE

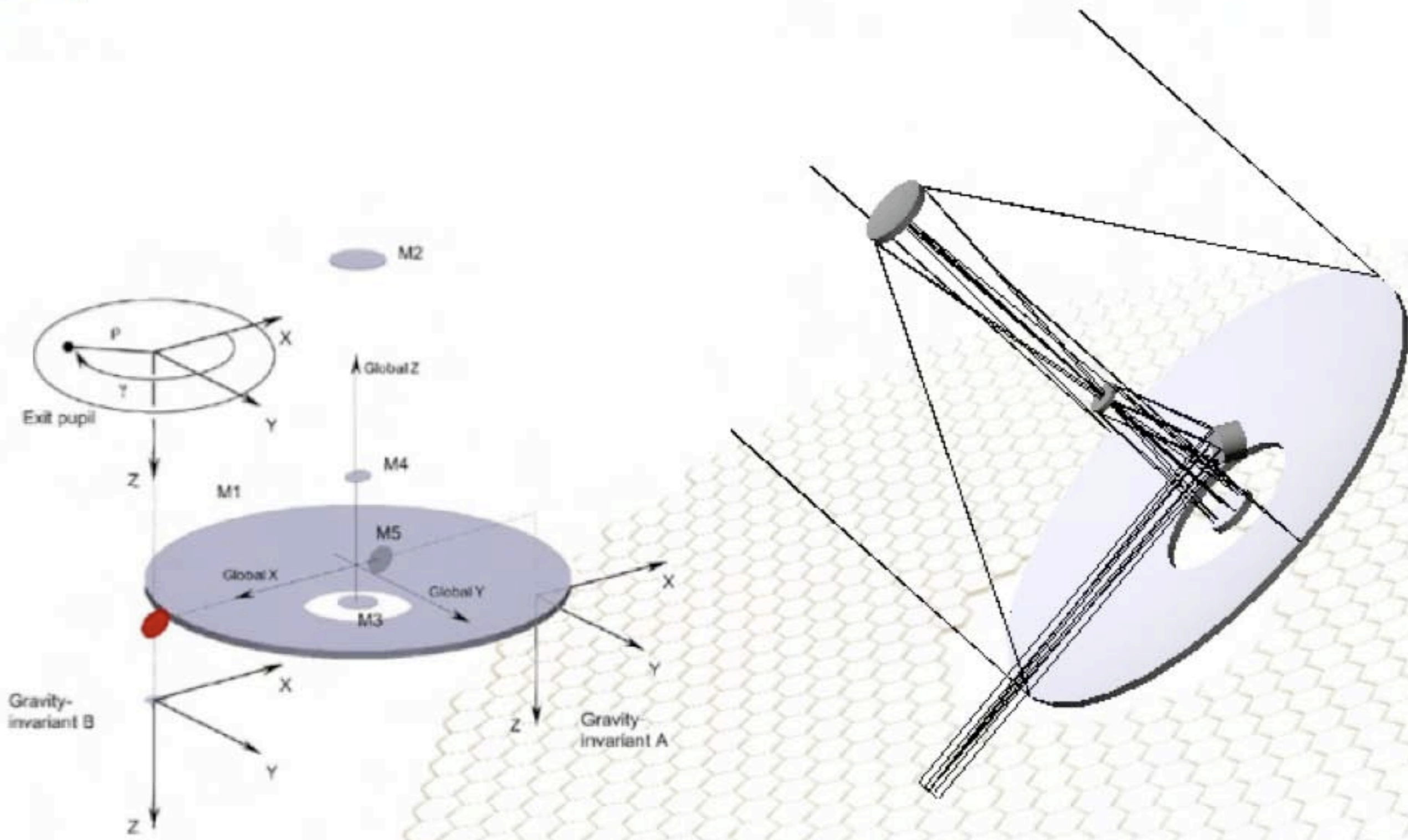





# TOP LEVEL REQUIREMENTS

- **Diameter:  $\geq 42\text{m}$  (area  $\geq 1200 \text{ m}^2$ )**
  - Alt-Az, F/15 to F/18, fully steerable (0-360,0-90). Operational ZD: 0-70
- **Adaptive telescope**
  - GLAO correction ( $\geq 5$  arcmin, 90% sky, 80% time)
    - better than 2x FWHM improvement for median seeing conditions
  - Post-focal: SCAO, MCAO, LTAO, ExAO, MOAO, ...
- **Science field of view:**
  - 10 arcmin unvignetted. Diffraction limited by design
  - 5 arcmin unobscured by guide probes
- **Wavelength range: 0.3 – 24  $\mu\text{m}$**
- **Transmission @Nasmyth:**
  - $>50\%$  at  $>0.35 \mu\text{m}$ ,  $>60\%$  at  $>0.4 \mu\text{m}$ ,  $>70\%$  at  $0.7 \mu\text{m}$ ,  $>80\%$  at  $> 1 \mu\text{m}$
- **Focal stations**
  - Two Nasmyth (multiple instruments, including gravity invariant option)
  - At least one Coudé
  - Fixed instrumentation (fast switching:  $< 10$  min same focus,  $< 20$  otherwise)





# NOVEL 5-MIRROR OPTICAL DESIGN

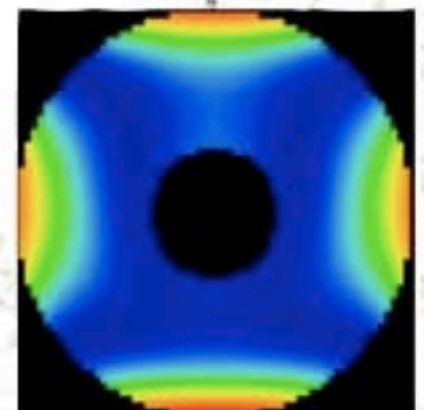
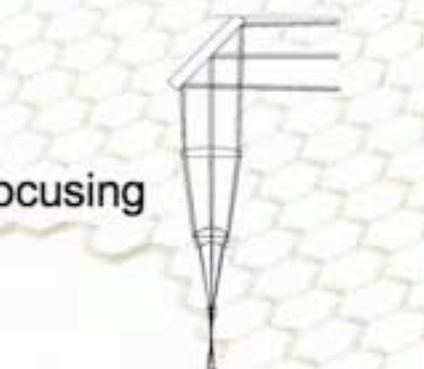
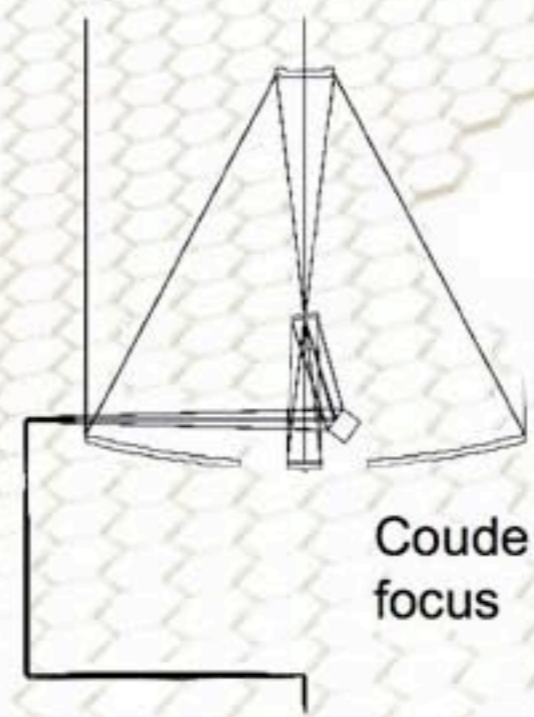
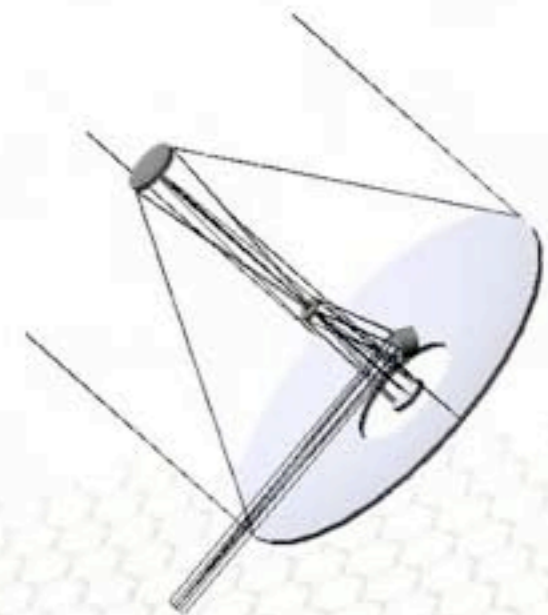
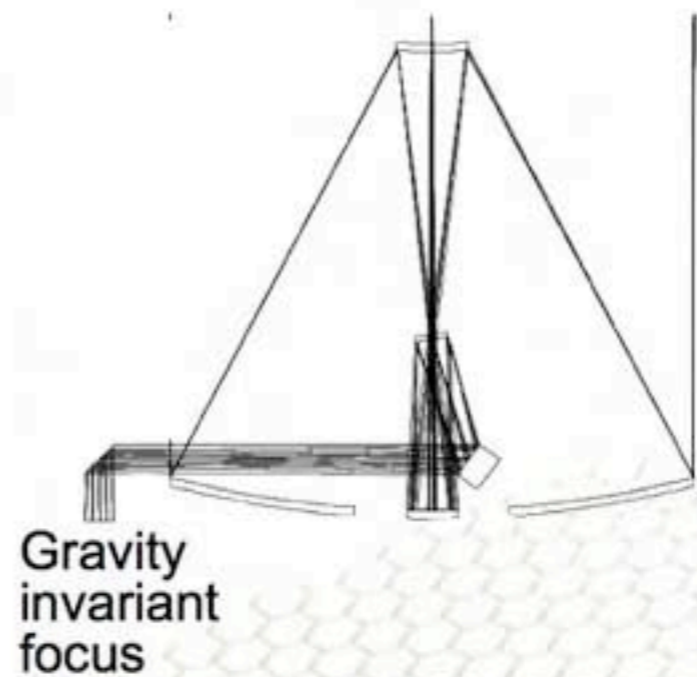
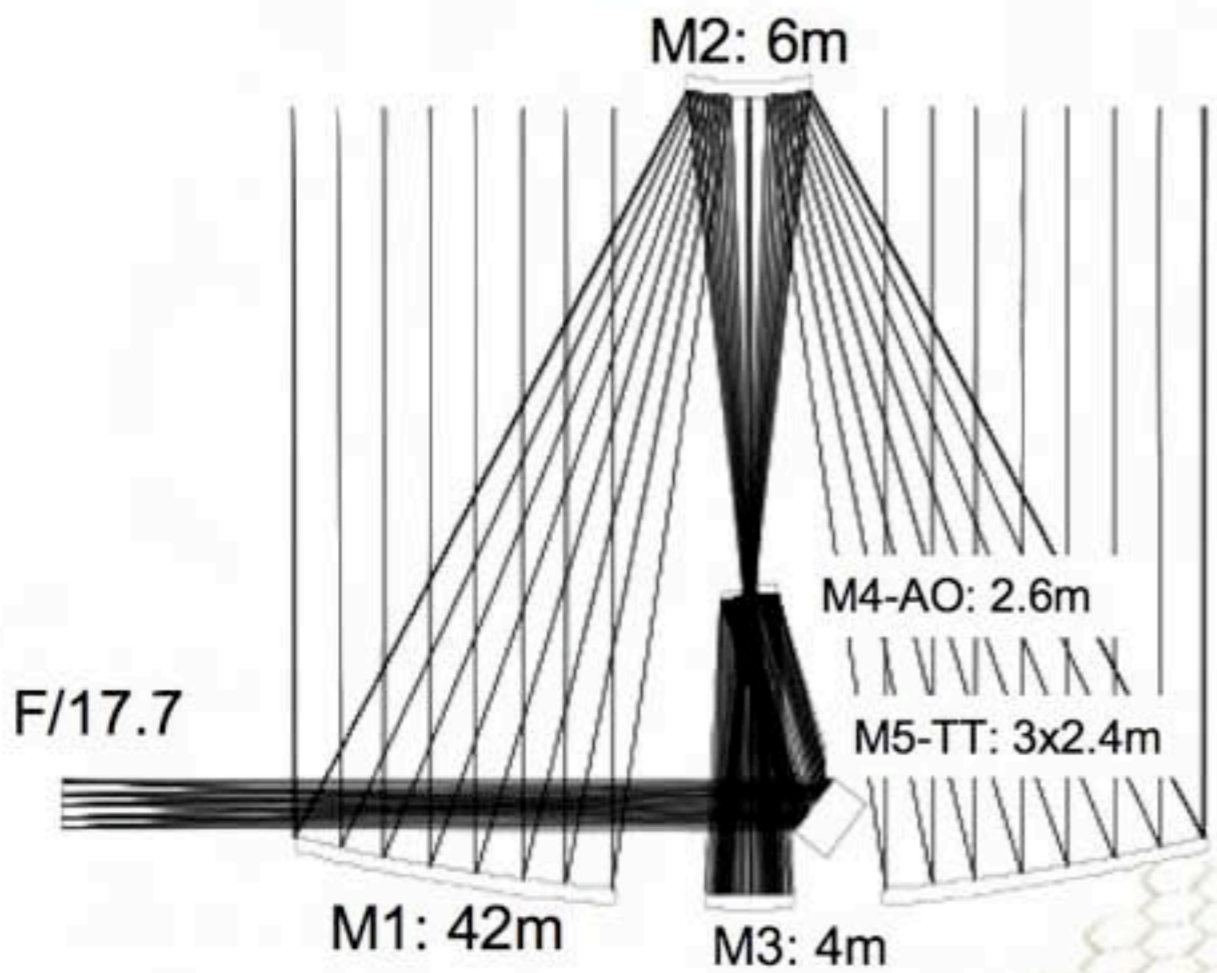
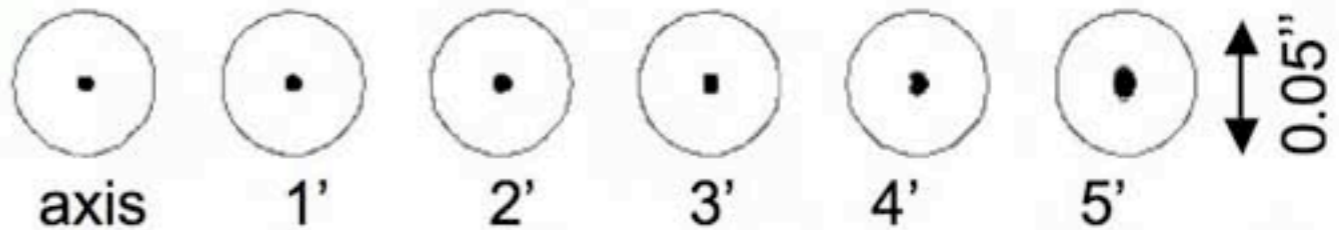

LGS wavefront  
 4.5' off axis  
 106 nm rms

**Main advantages:**

- *image quality*
- *flat, telecentric FoV*
- *zoom capability*
- *laser "friendly"*



# TELESCOPE MOUNT

- Two cradle solution
- **Two industrial contracts concluded**
- **FEED ongoing**
- Confirm cost and schedule
- Excellent stiffness ( $\geq 3\text{Hz}$ )

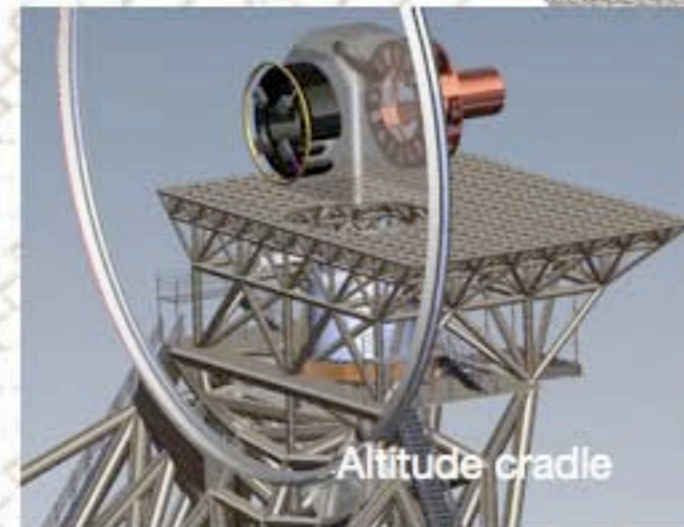
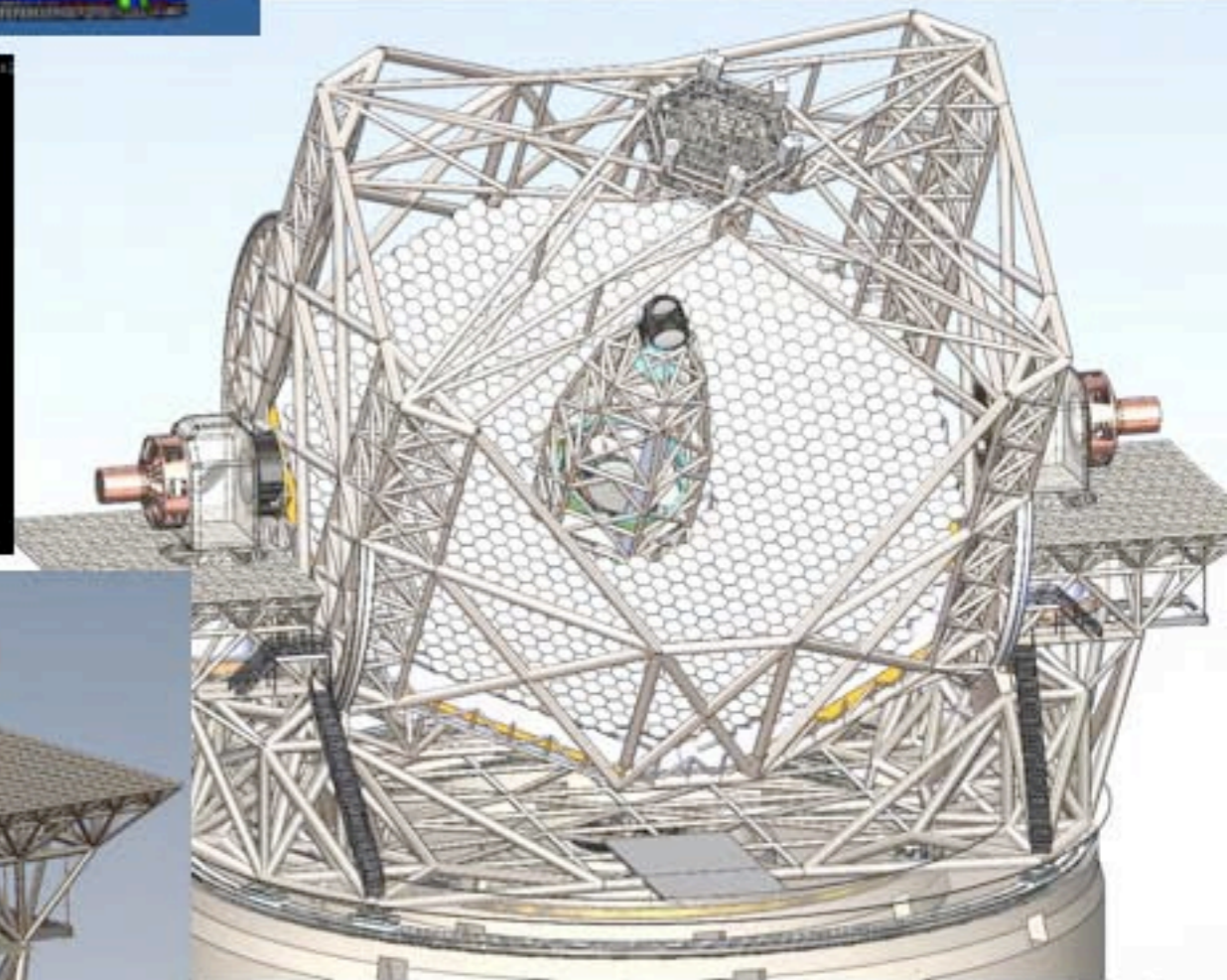
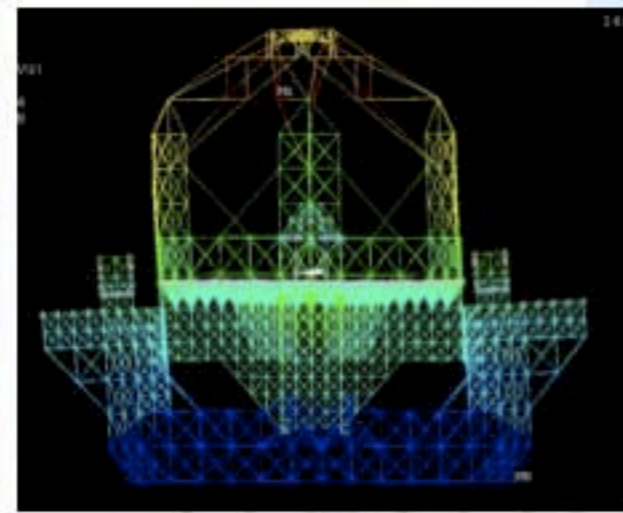
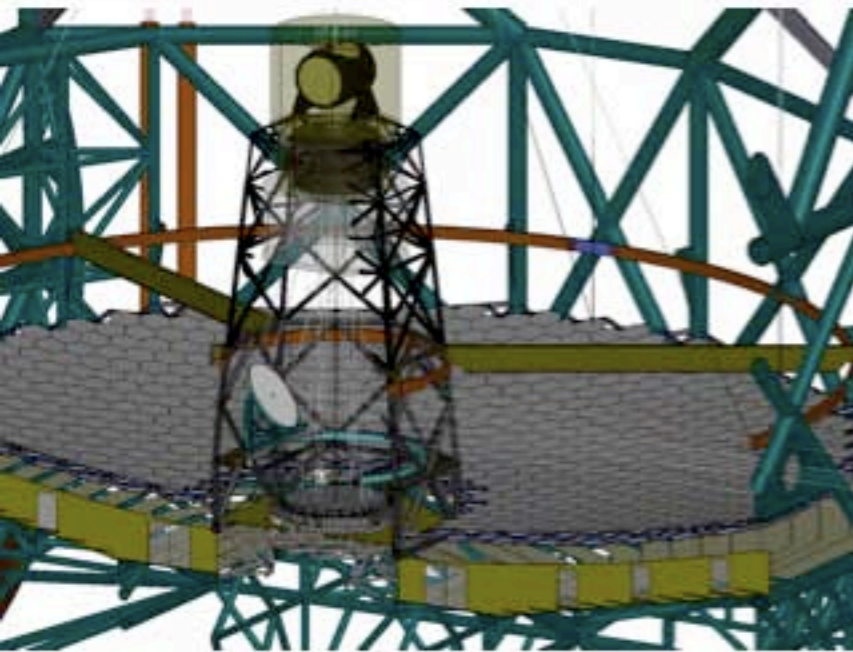
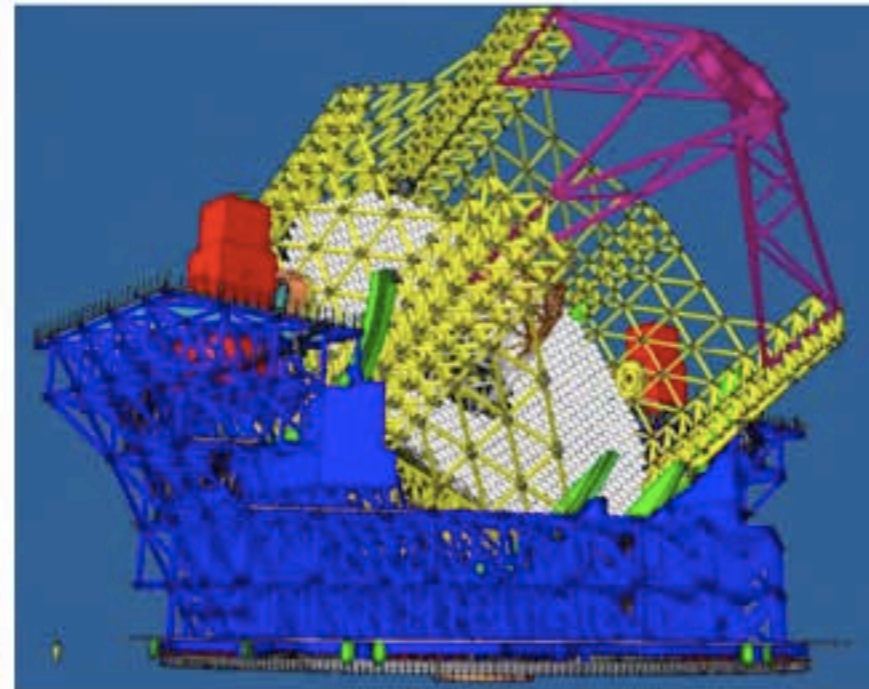
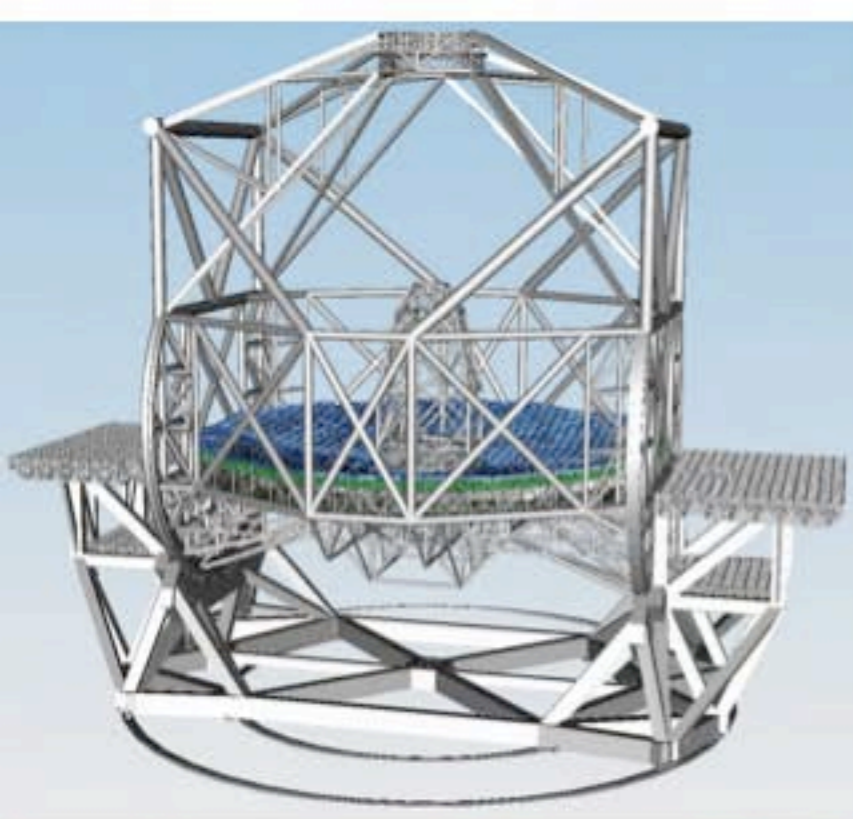

Azimuth track

Altitude cradle





# THE M1 MIRROR

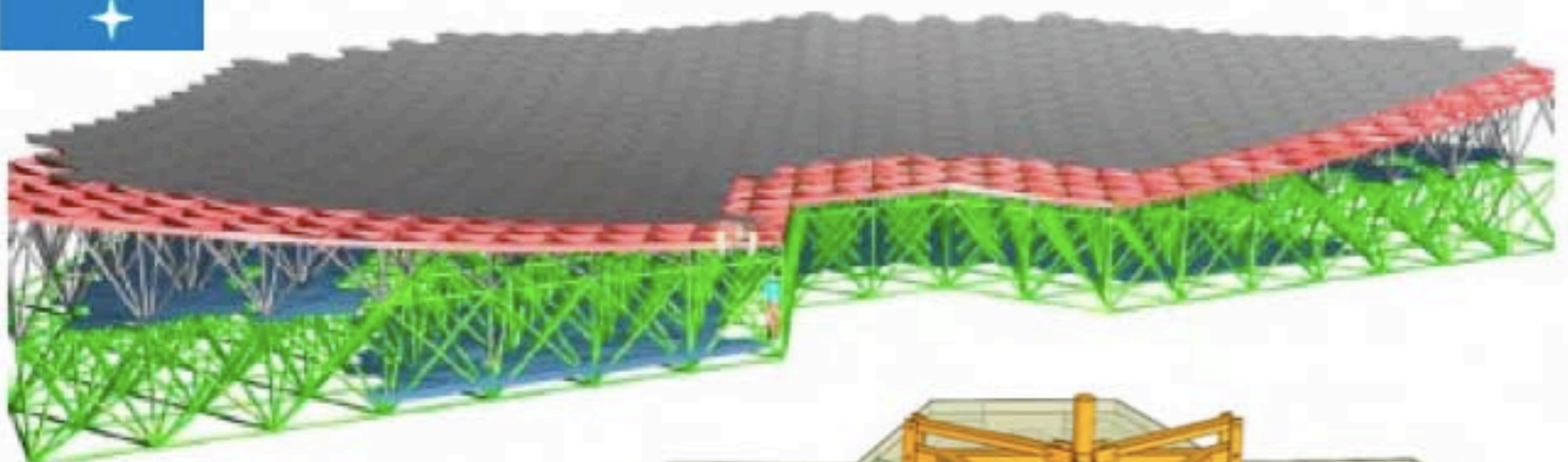

Segment dimensions:  
1428.64 mm – 1414.00 mm  
(1387.29 - 1427.13 @pupil)  
central thickness: 50 mm  
gap: 4 mm  
bevel 2: mm (goal 1.5)

1148 segments:  
984 mirror +  
1 spare/family

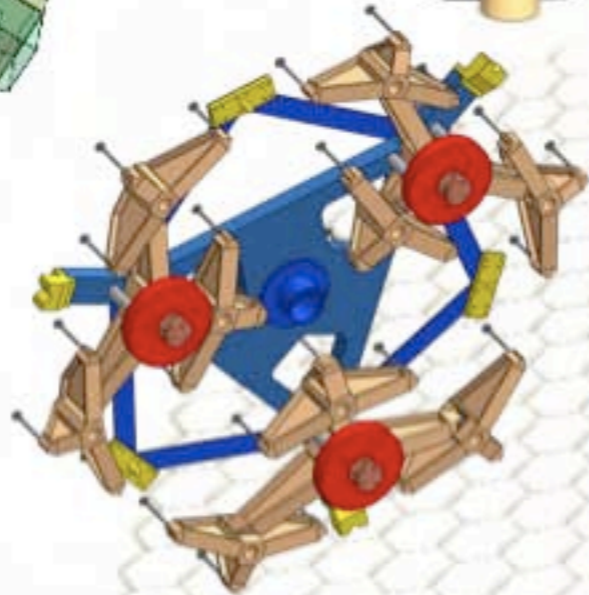
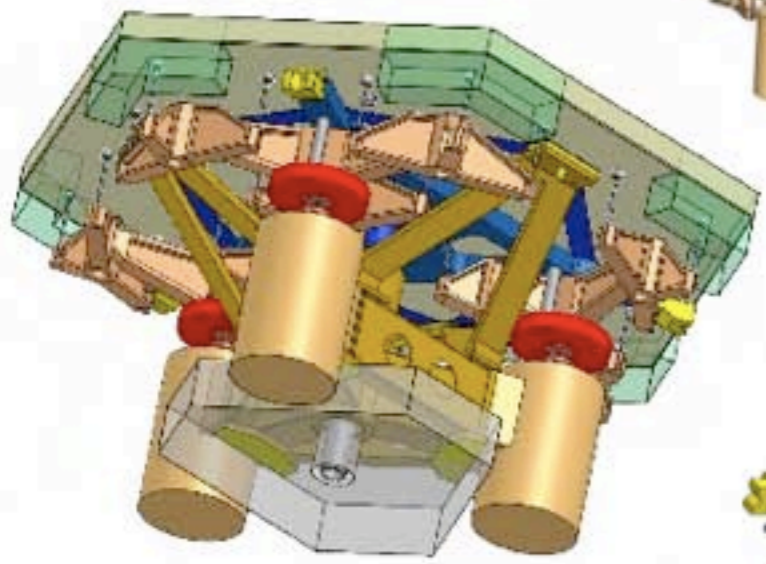
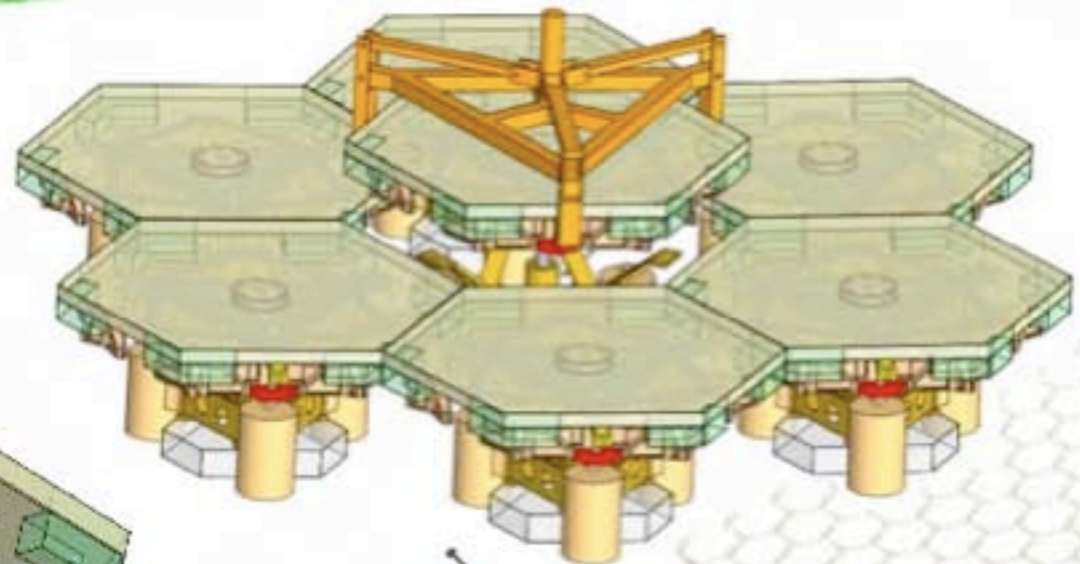

Wavefront degradation (0.496 um RMS) PSD along mirror modes

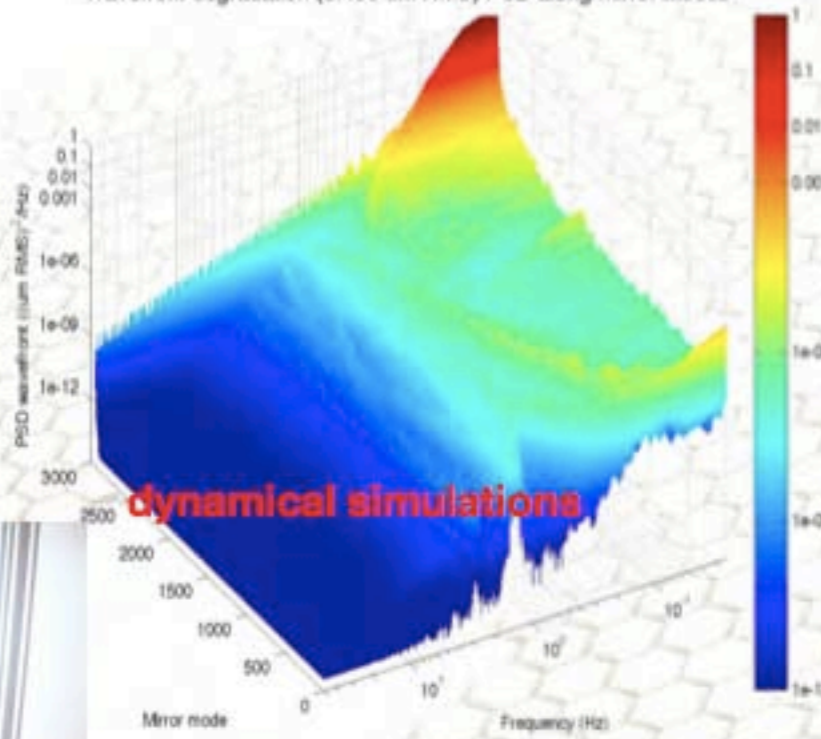

dynamical simulations

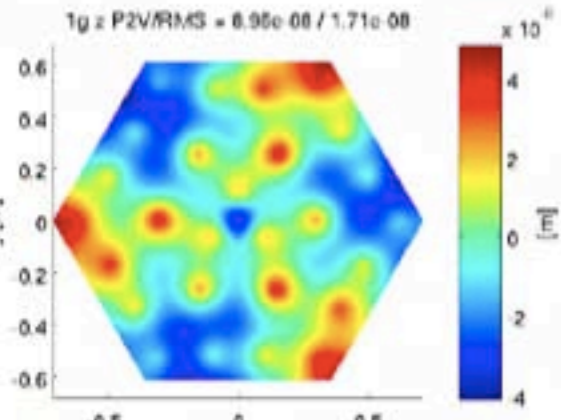

**2 x 7 prototype segments being produced by two independent contractors. Production processes being developed under contract to ESO**





# THE M2 UNIT

M2 cell design contract ongoing

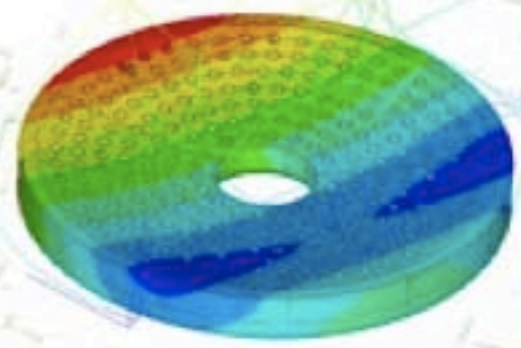
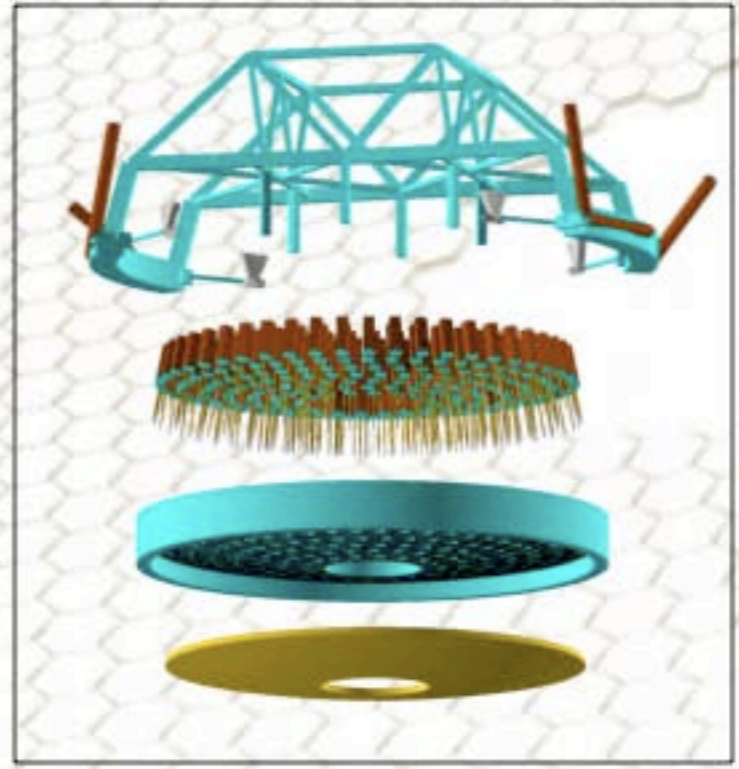
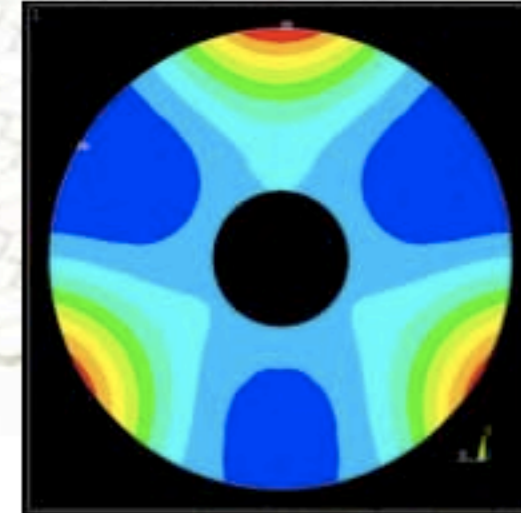
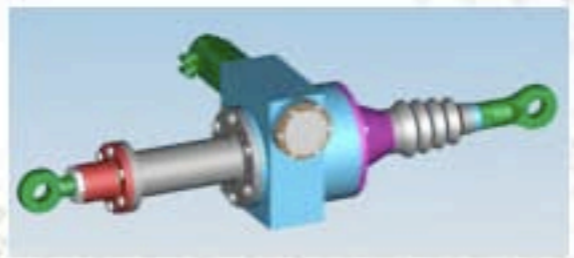
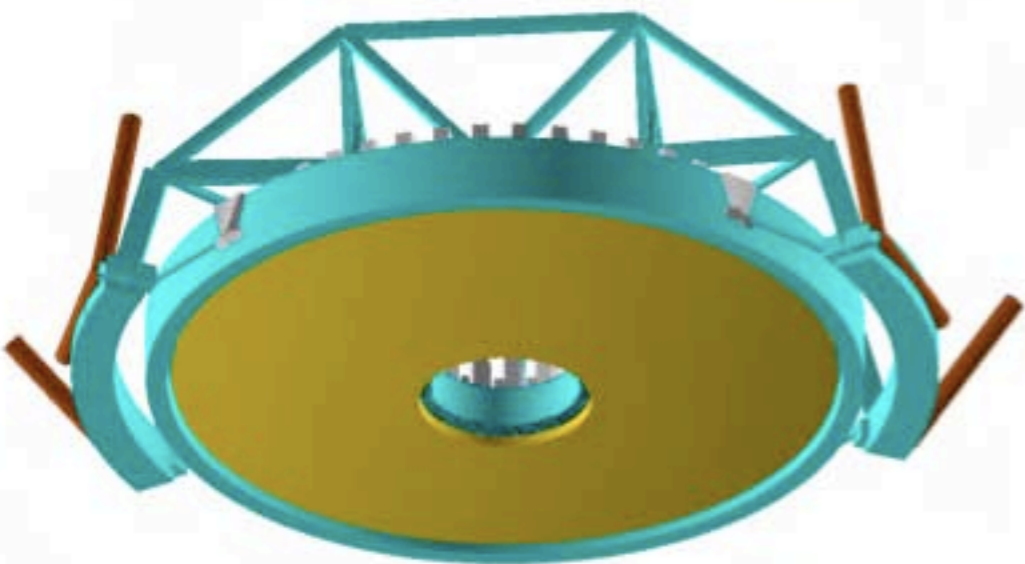
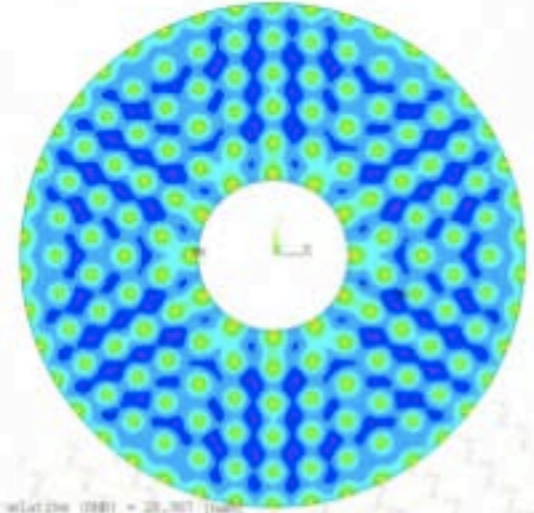
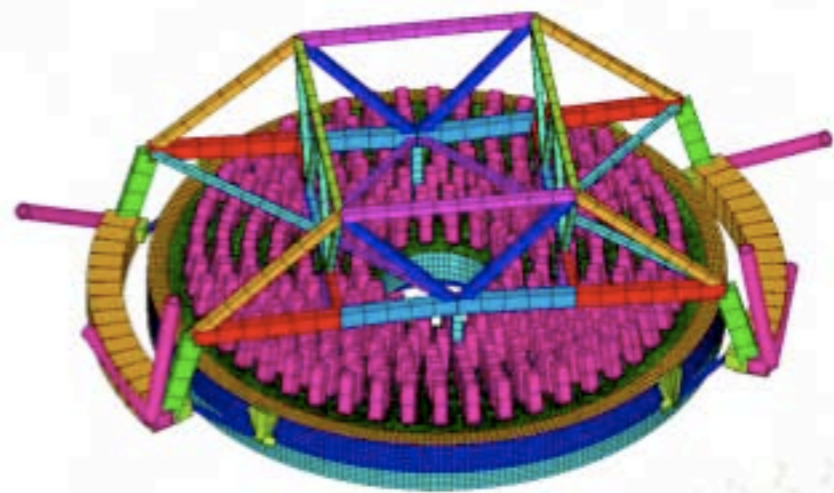
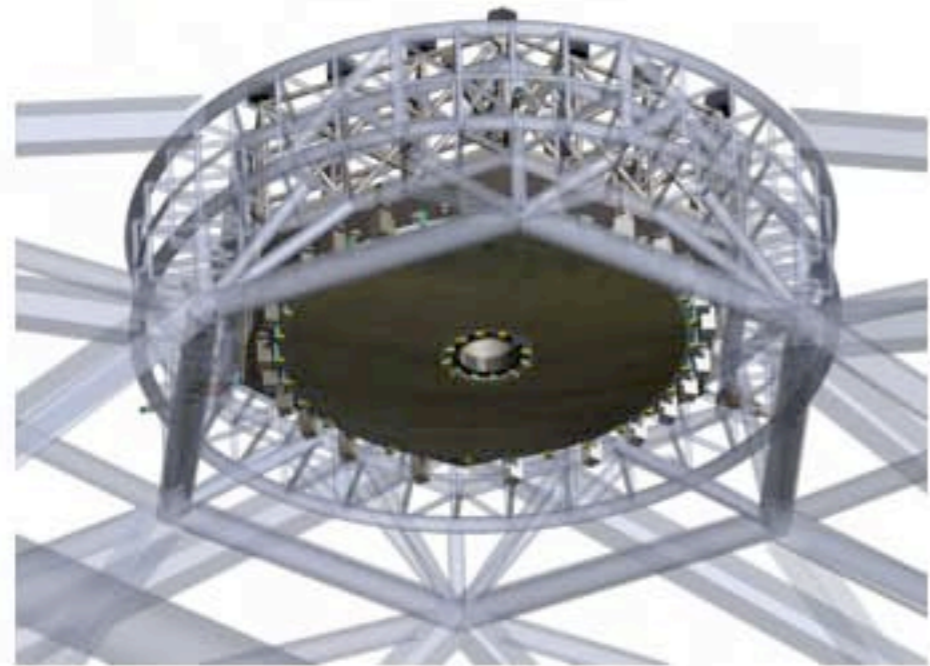





# THE M4 ADAPTIVE MIRROR

Two industrial studies will deliver working prototypes

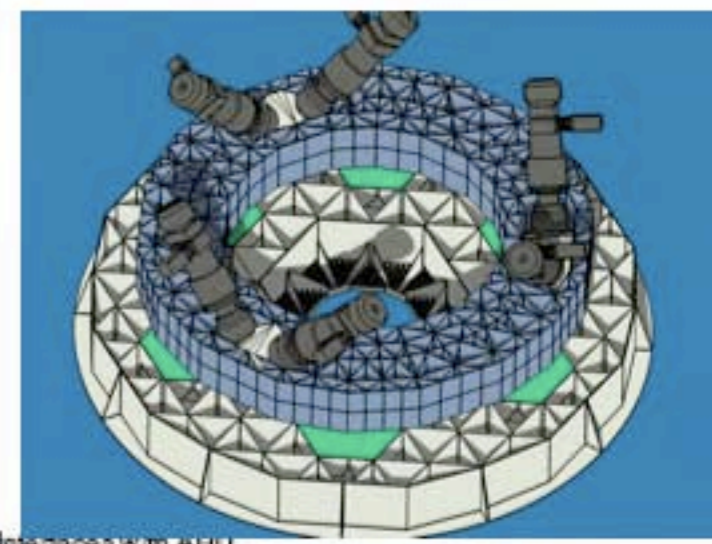

Interfaces with AFU

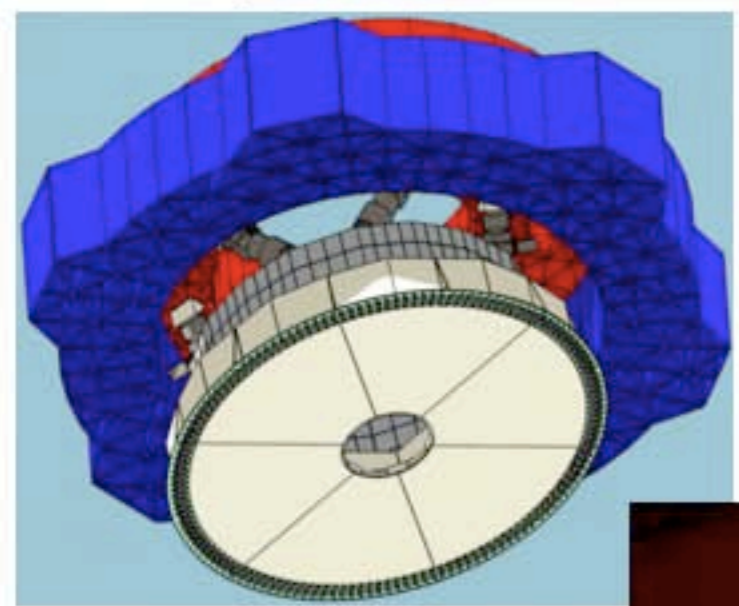

Two contracts running to PDR

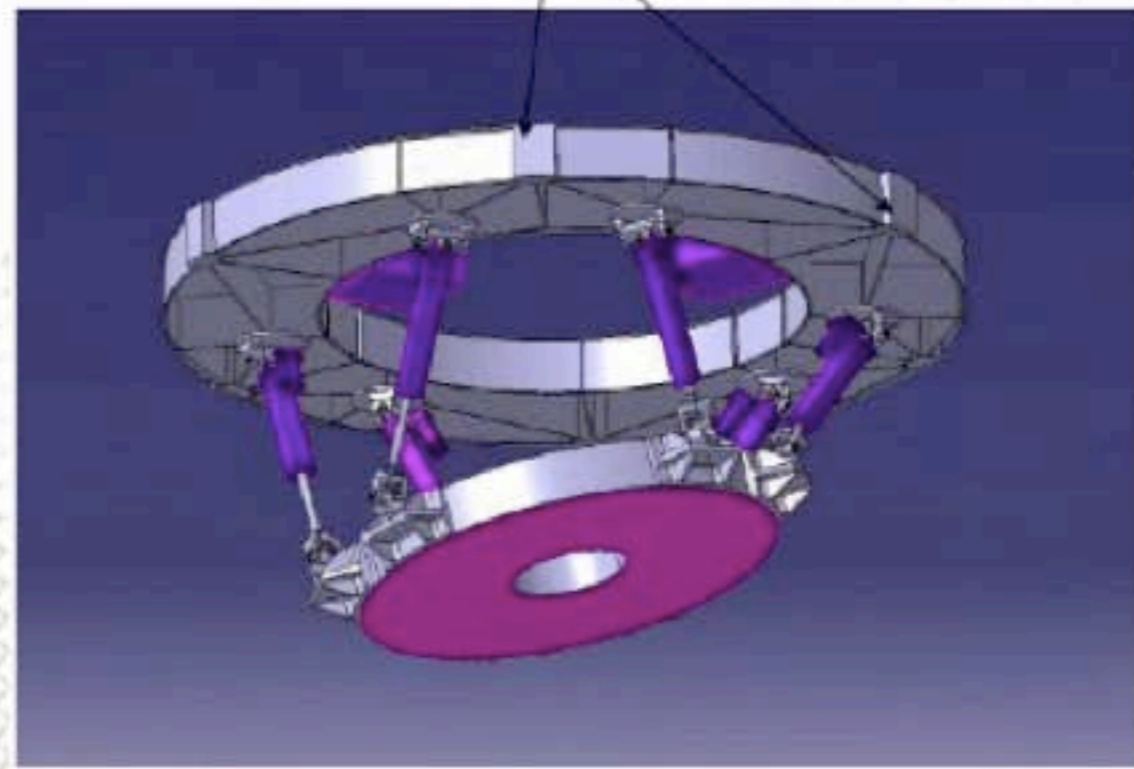
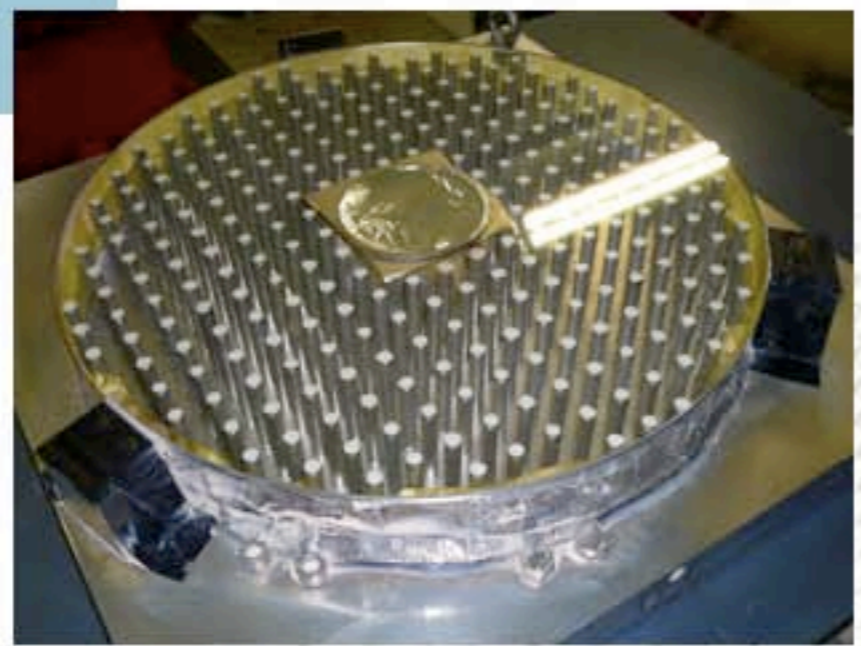

CAD view of the M4 mounting structure holding the 6 feet and the mirror

### Specs:

- diameter 2.6 m
- less than 10 tons
- fitting error < 145 nm RMS for median seeing

Either voice coil 30-mm pitch or piezo 20-mm pitch, resulting in 6000-10000 actuators

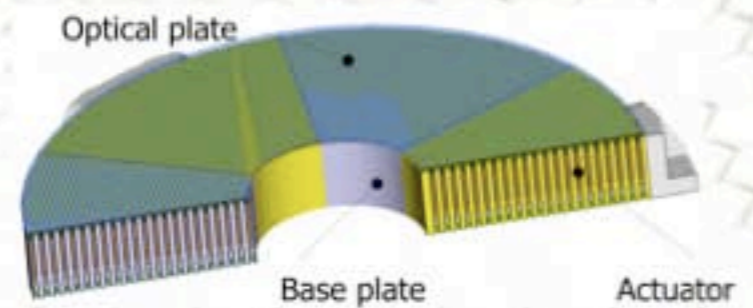





# THE M5 FIELD-STABILIZATION MIRROR

## M5 field stabilisation unit

Deliverable of industrial electromechanical study: scale 1 prototype

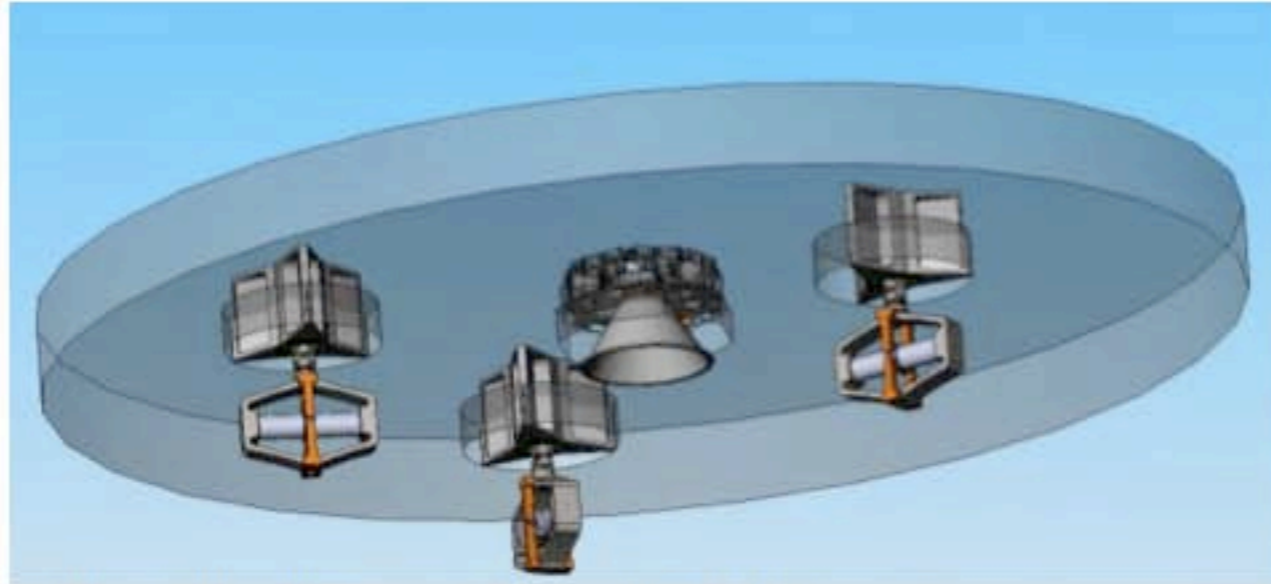

Backside with support elements and actuators



M5 actuator breadboard

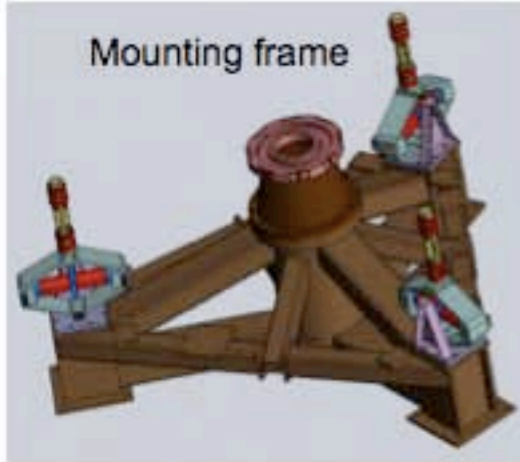

Mounting frame

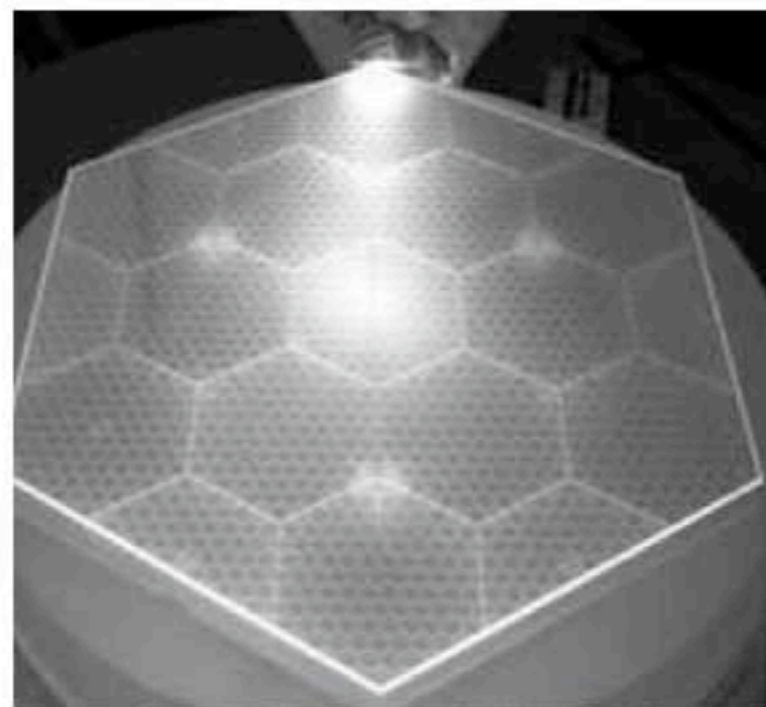

Example: ASMD mirror  
Lightweight ULE (JWST)

## M5 mirror

Flat, 3x2.4m  
ultra-lightweight mirror  
goal: 40 kg/m<sup>2</sup>

Example: ASMD mirror  
(1.4 m - JWST study)

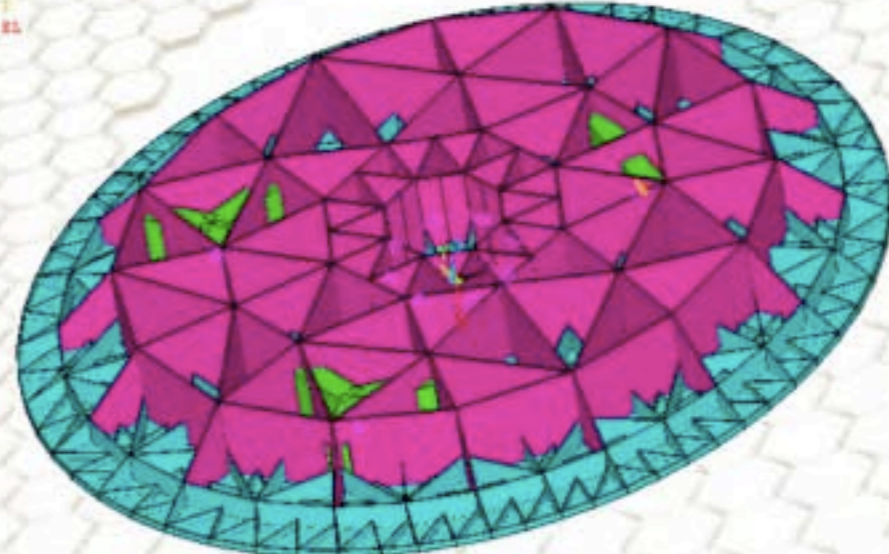
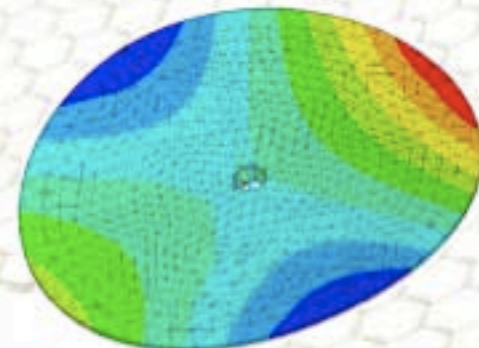
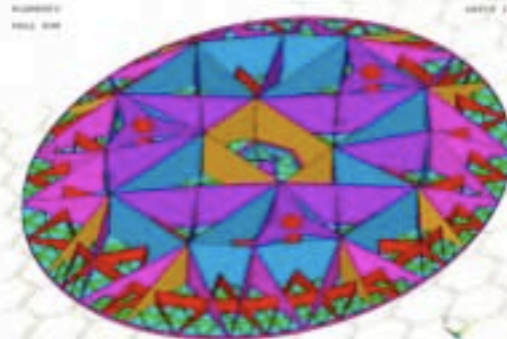

Alternative SiC design (67 kg/m<sup>2</sup>) design



# THE DOME

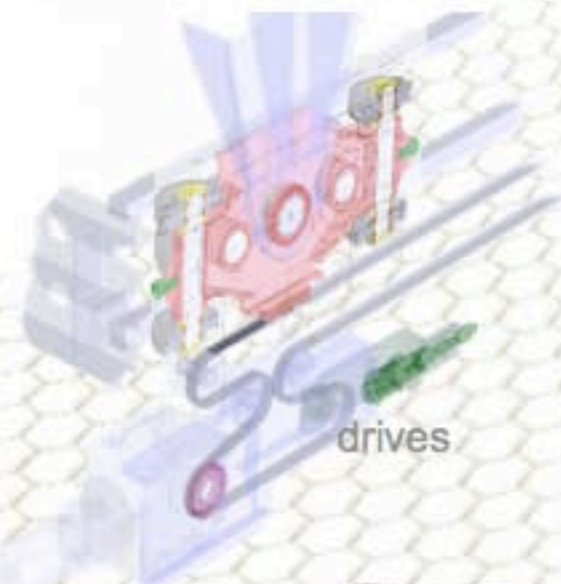
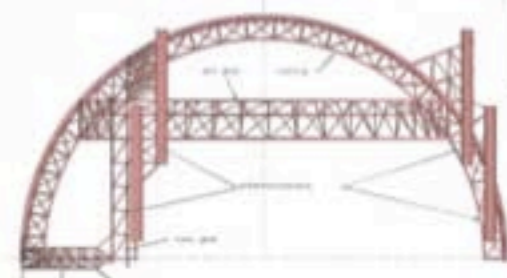
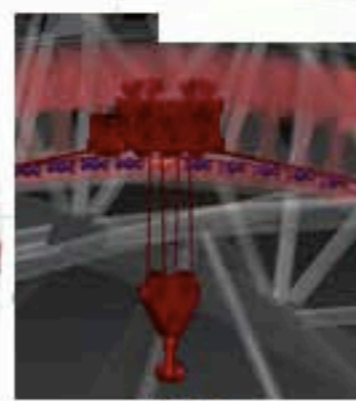
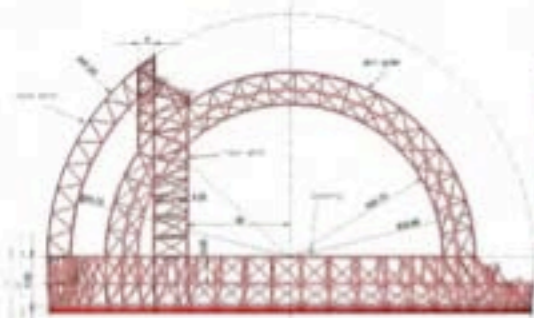
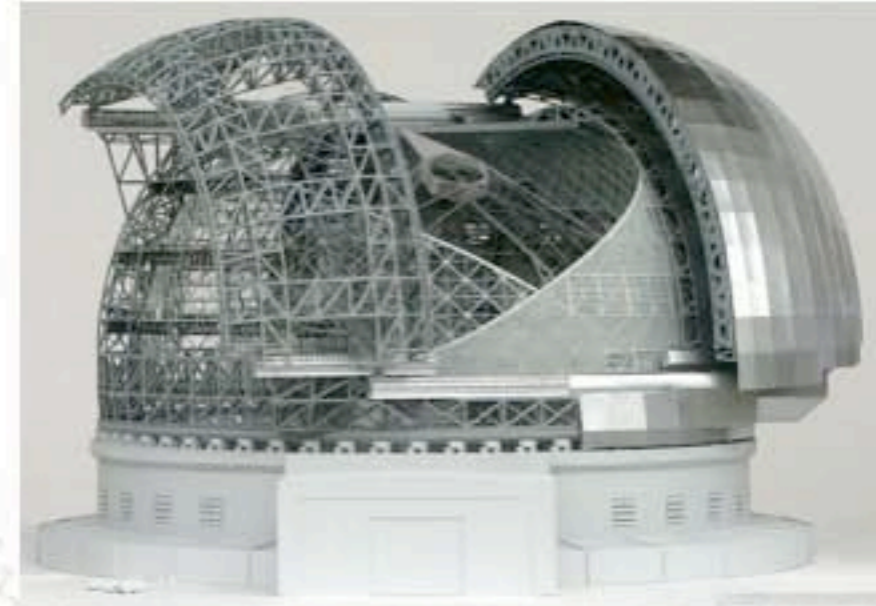
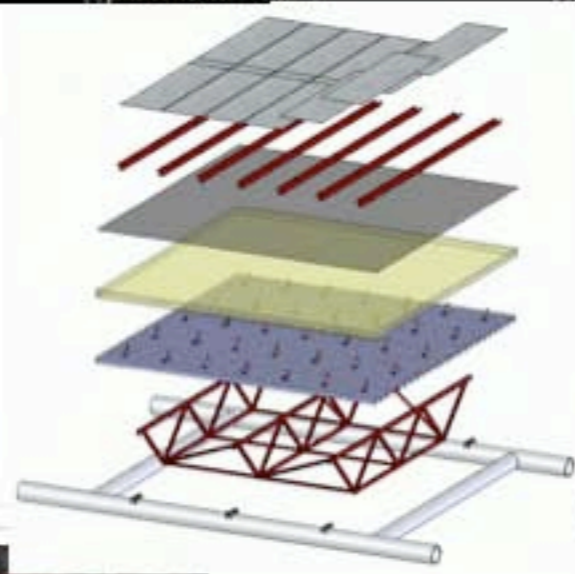
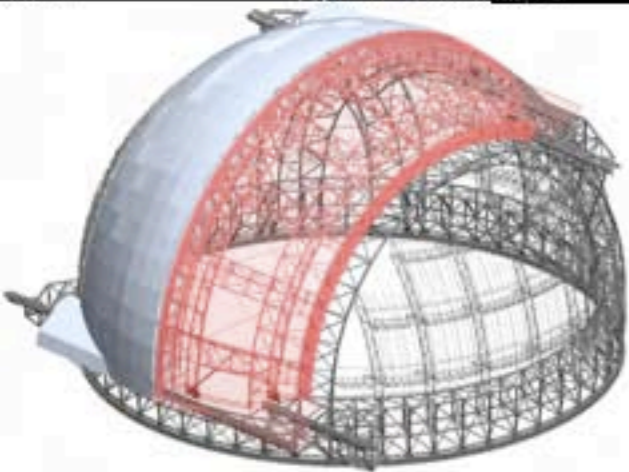
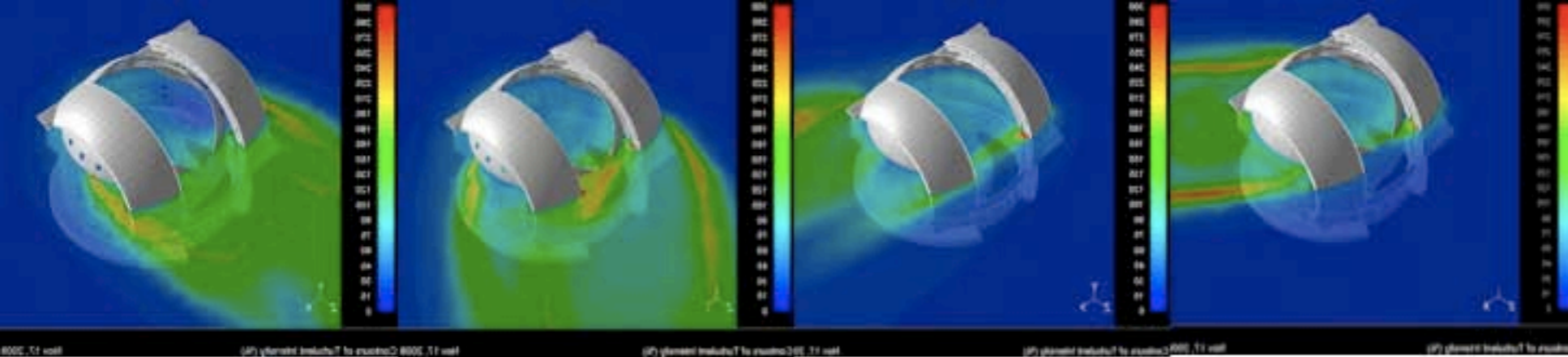

Two preliminary design contracts concluded providing schedule and cost. FEED ongoing

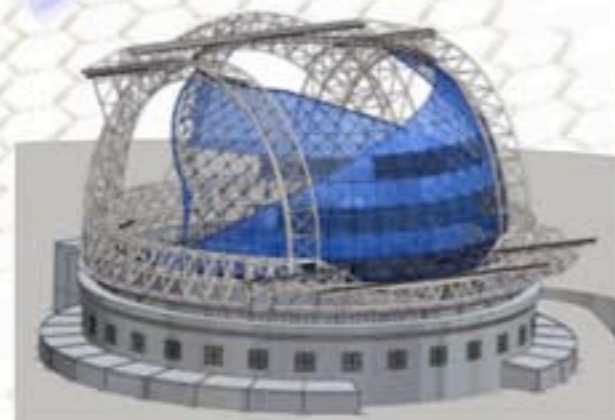
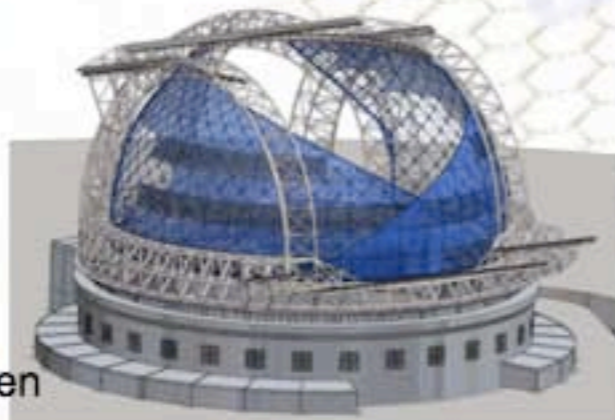
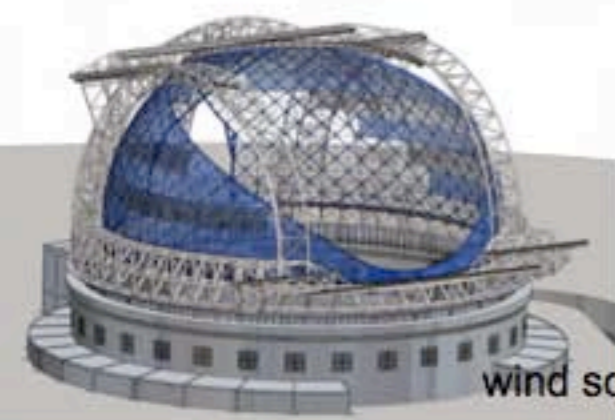





# FE MODELS

## Global FE Models

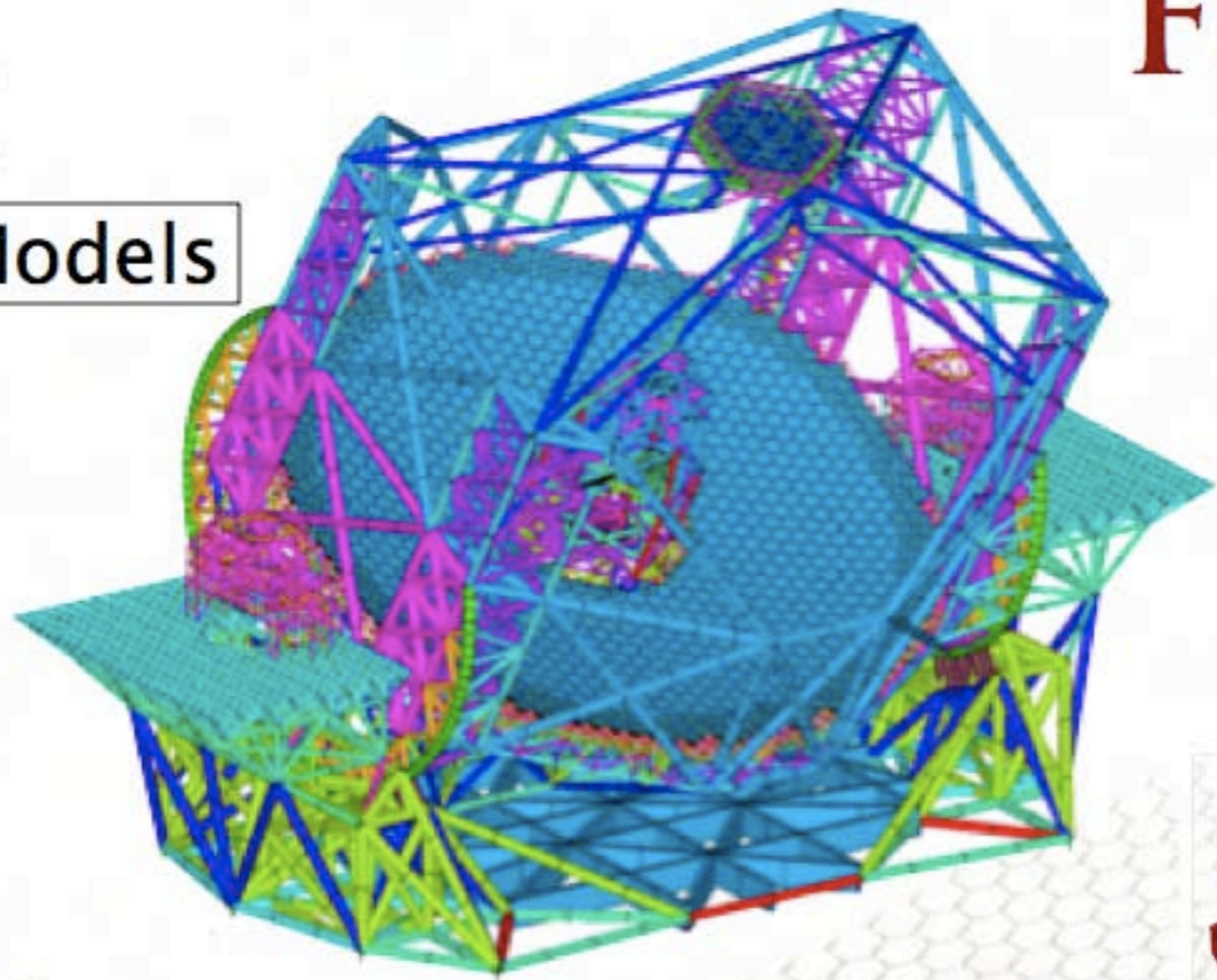
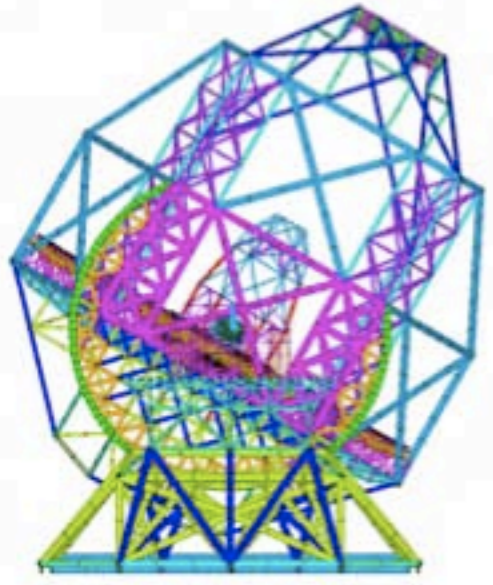

100,000 elements  
36,000 nodes

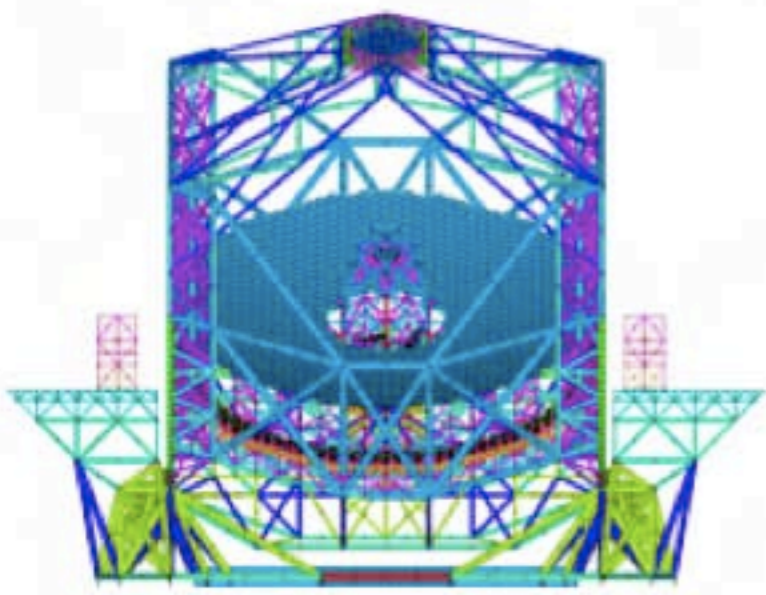

M2 Unit  
250,000 elements  
240,000 nodes

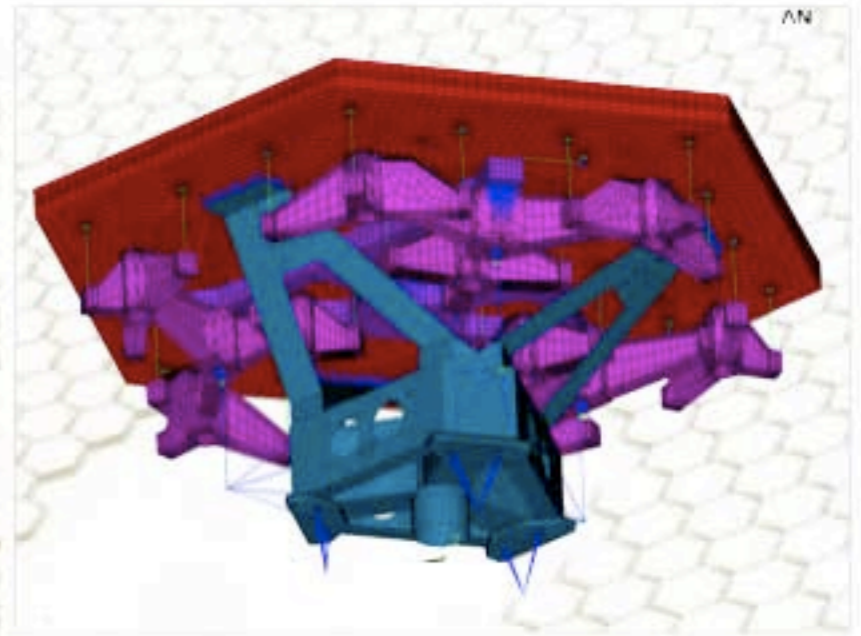
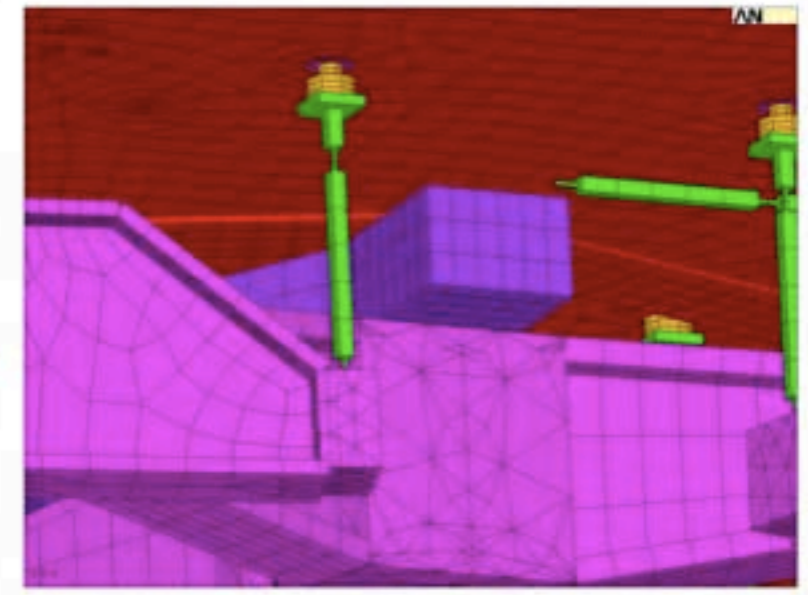
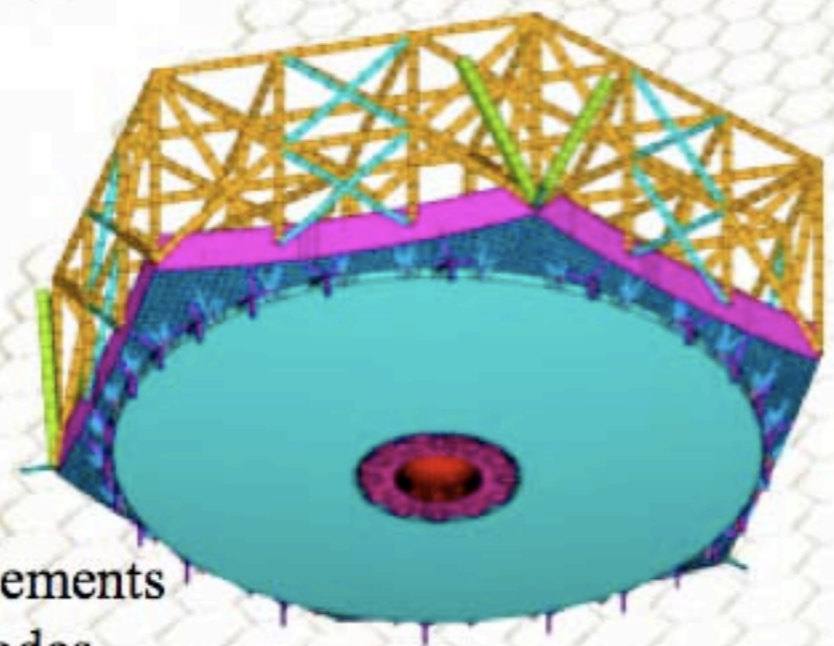

M1 Segment Support  
155,000 elements  
389,000 nodes

## Subsystems and local FE Models





# ALIGNMENT CONTROL SCENARIO

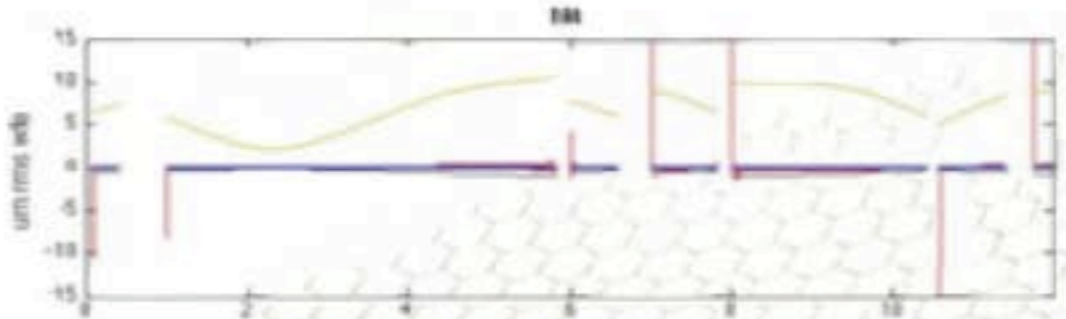
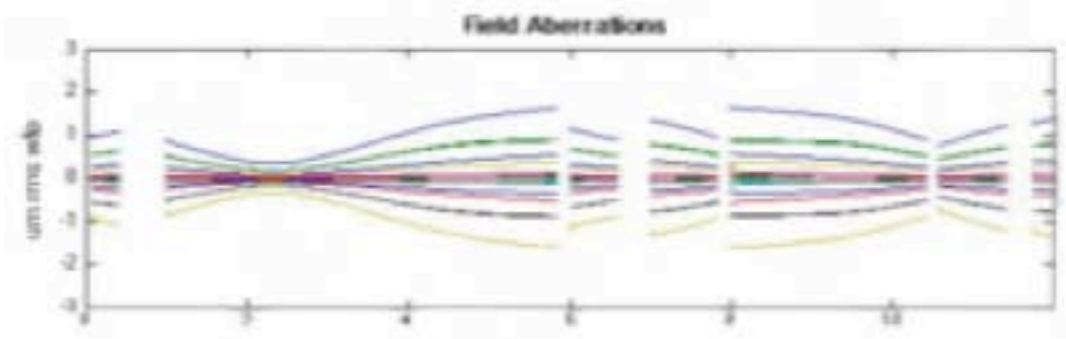
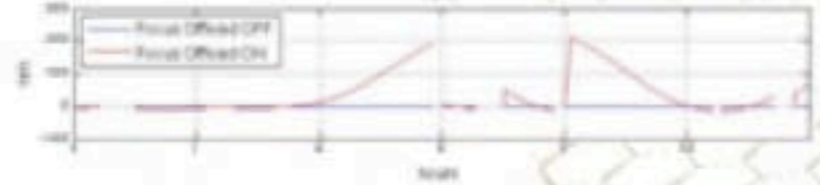
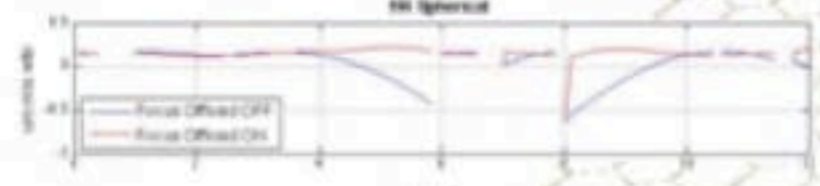
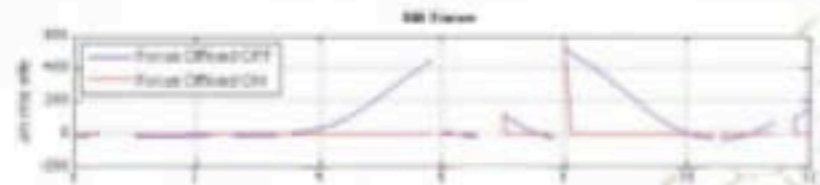
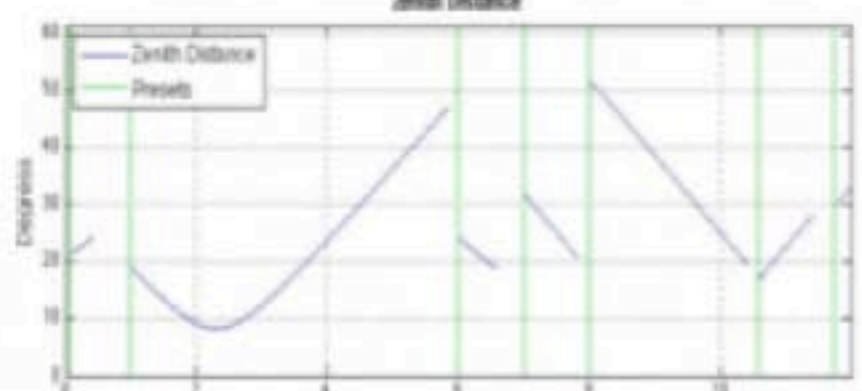
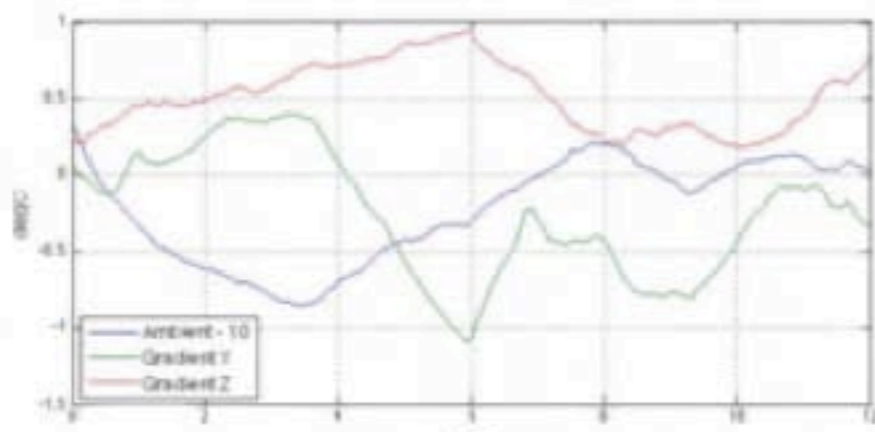

Figure 3 Field Aberrations and  $M1$  /  $M2$  Alignment Off

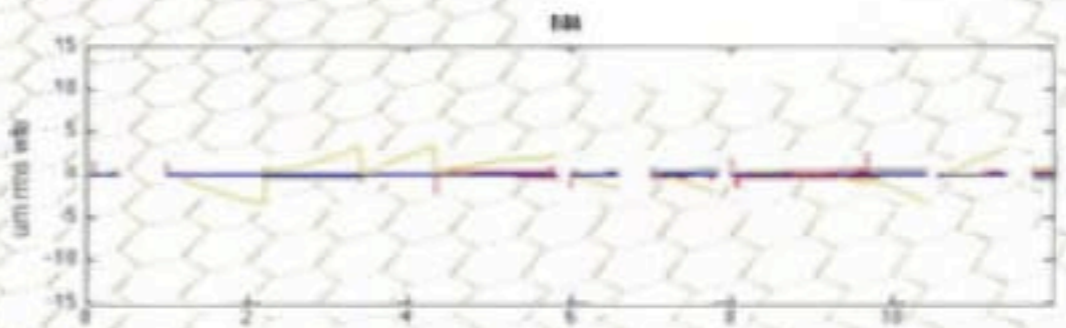
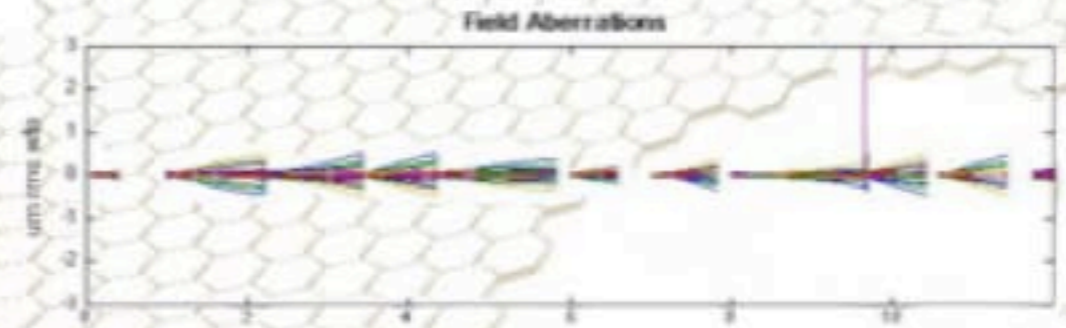
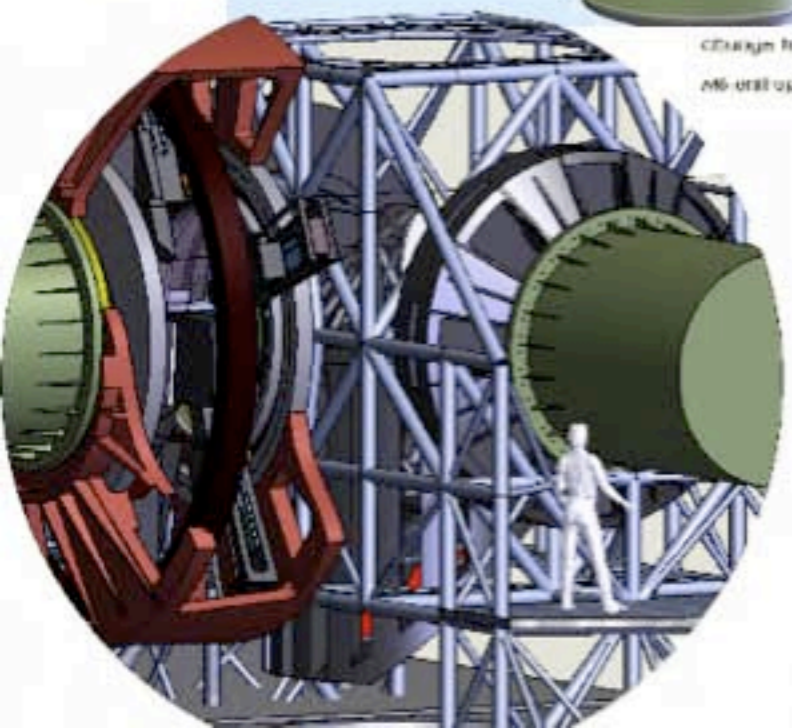
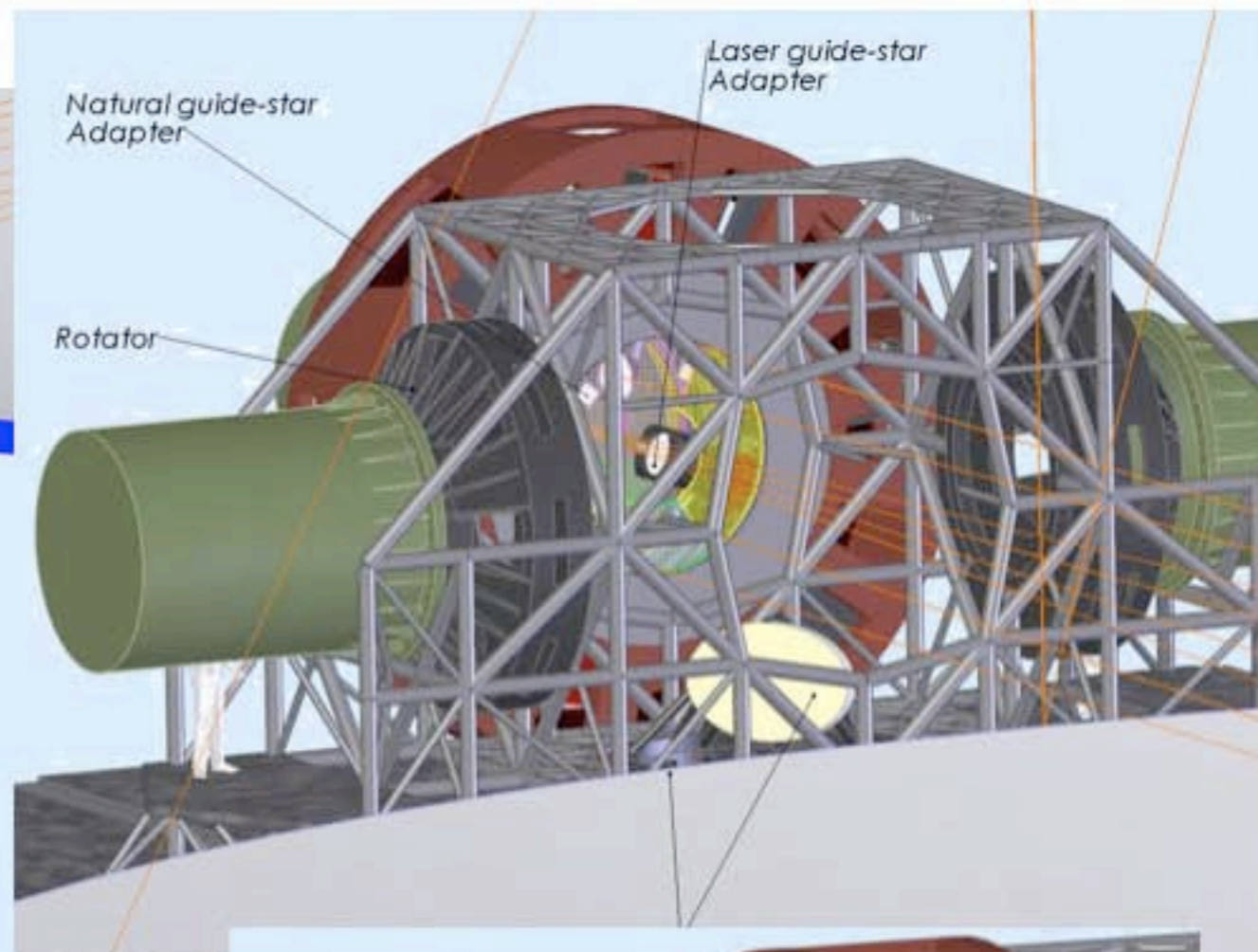
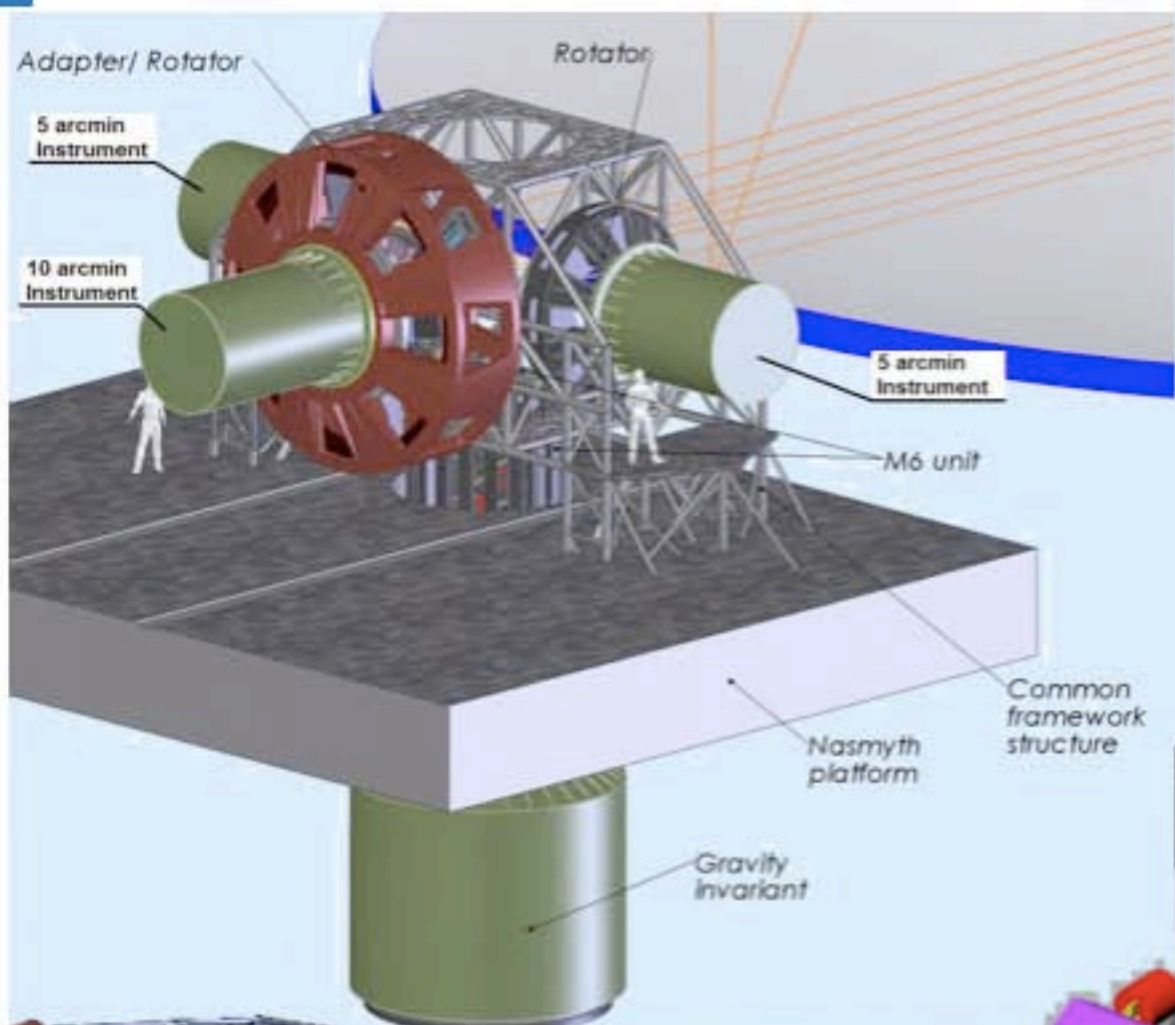

Figure 4 Field Aberrations and  $M1$  /  $M2$  Alignment On





# PRE FOCAL STATIONS



change to gravity invariant  
M6 unit upward rotation

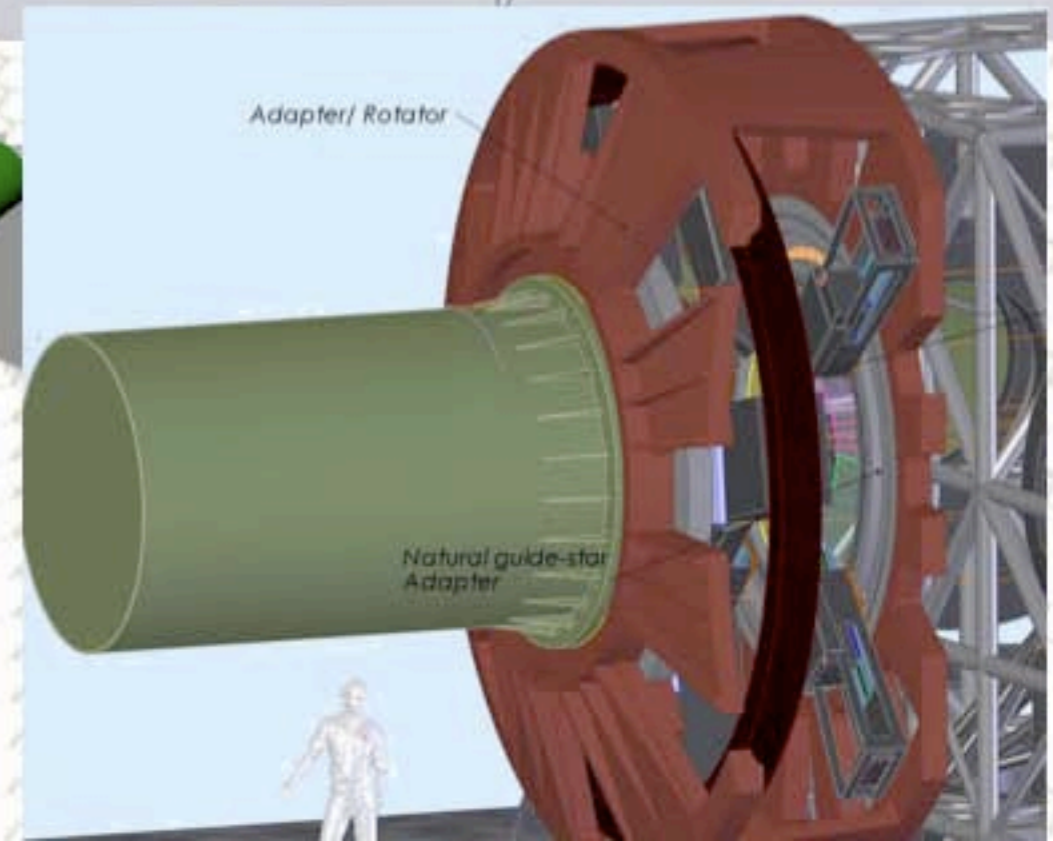
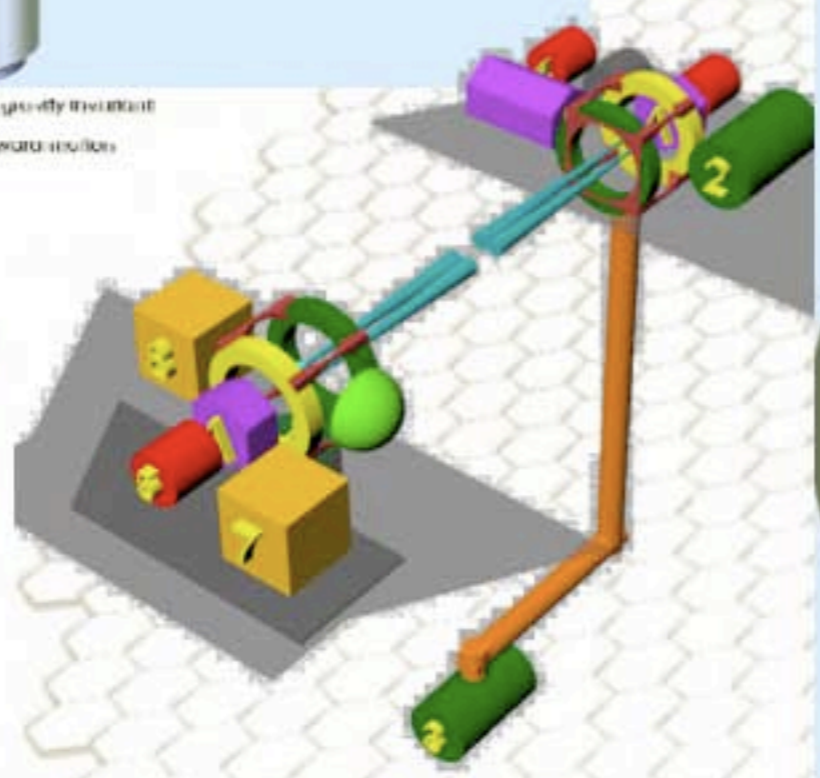





# INSTRUMENTATION: PHASE A STUDIES

ACRONYM (P.I.)	INSTRUMENT TYPE
<i>EAGLE</i> (J.G. Cuby)	<b>Wide Field, Multi IFU NIR Spectrograph with MOAO</b>
<i>EPICS</i> (M. Kasper)	<b>Planet Imager and Spectrograph with XAO</b>
<i>MICADO</i> (R. Genzel)	<b>Diffraction-limited NIR Camera- AO assisted</b>
<i>HARMONI</i> (N. Thatte)	<b>Single Field, Wide Band Spectrograph - AO assisted</b>
<i>CODEX</i> (L.Pasquini)	<b>High Spectral Resolution, High Stability Visual Spectrograph</b>
<i>METIS</i> (B. Brandl)	<b>Mid Infrared Imager &amp; Spectrograph –AO assisted</b>
<i>OPTIMOS</i> (F.Hammer,- O.LeFevre)	<b>Wide Field , Visual, MOS (fibre or slit-based)- AO assisted?</b>
<i>SIMPLE</i> (L. Origlia)	<b>High Spectral Resolution NIR Spectrograph –AO assisted</b>
	<b>POST –FOCAL ADAPTIVE OPTICS MODULES</b>
<i>MAORY</i> (E. Diolaiti)	<b>Multi Conjugate AO module (high Strehl, field up to 2’)</b>
<i>ATLAS</i> (T. Fusco)	<b>Laser Tomography AO Module (high Strehl, narrow field)</b>





# PARAMETER SPACE

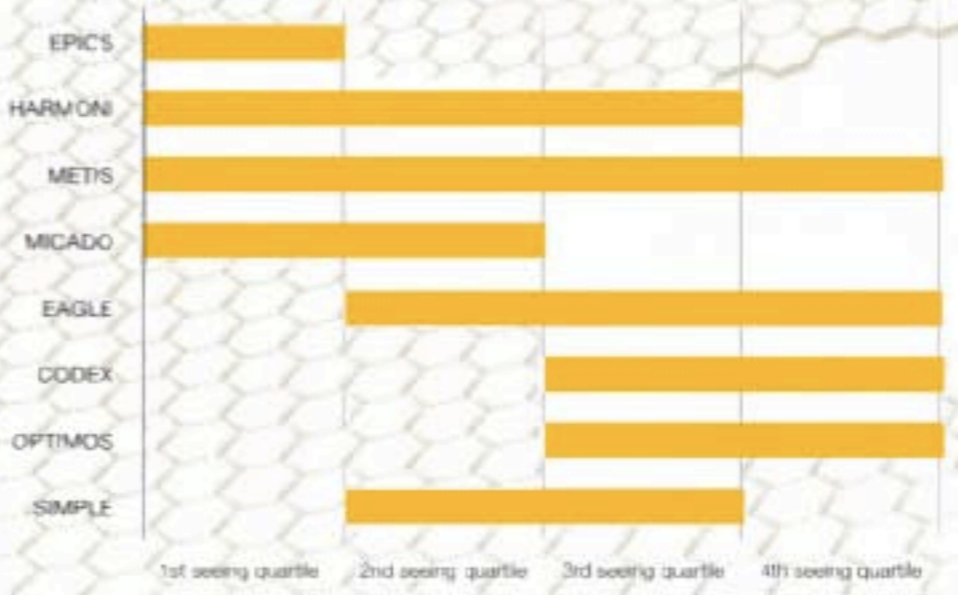
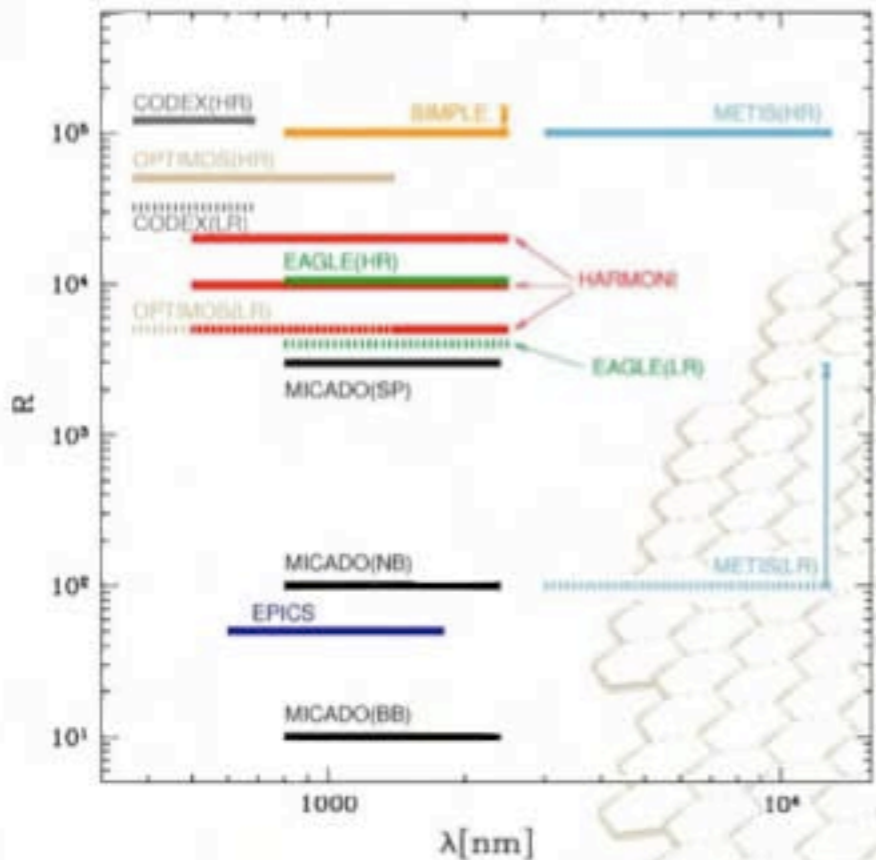
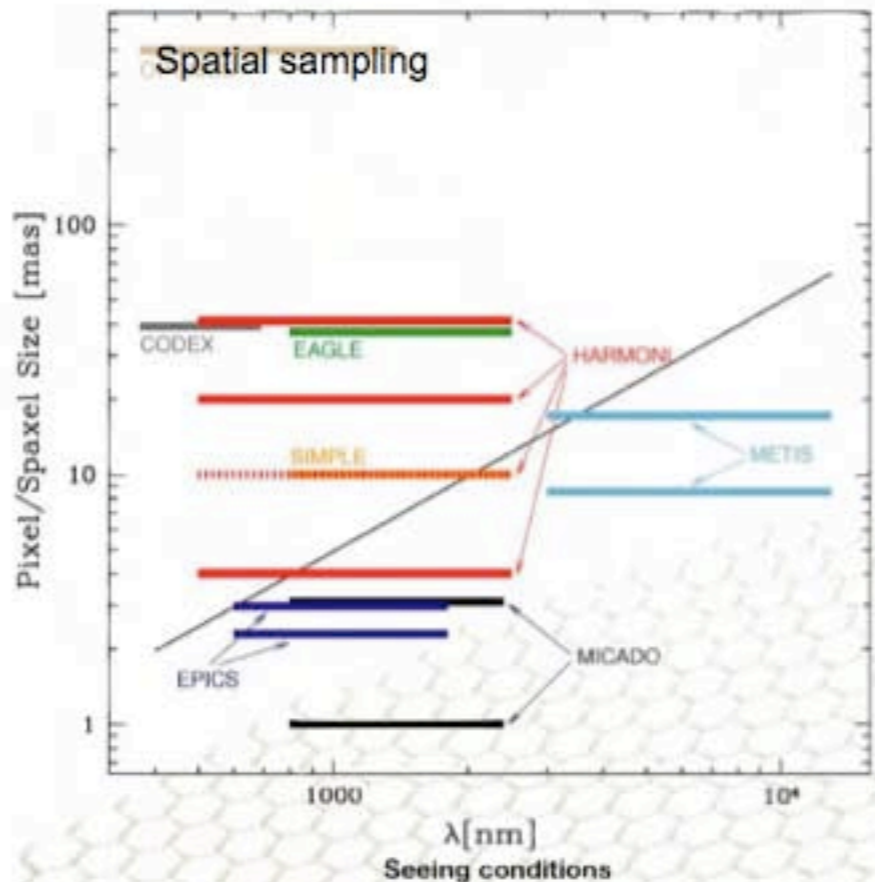
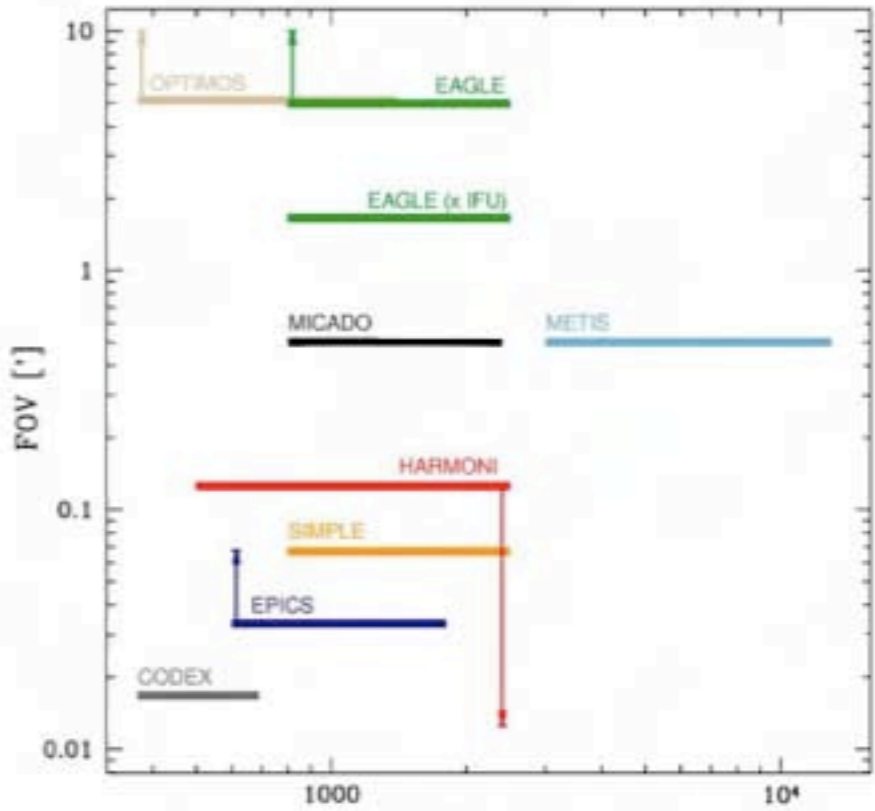

The current suite of instruments nicely covers the various seeing conditions. A plan for sequential implementation of the instruments at the E-ELT should take into account that at a given time all seeing quartiles can be used by the present instruments.





# MICADO

Concept for MICADO and its cryostat, approximately 2m across

Concept for MICADO optics

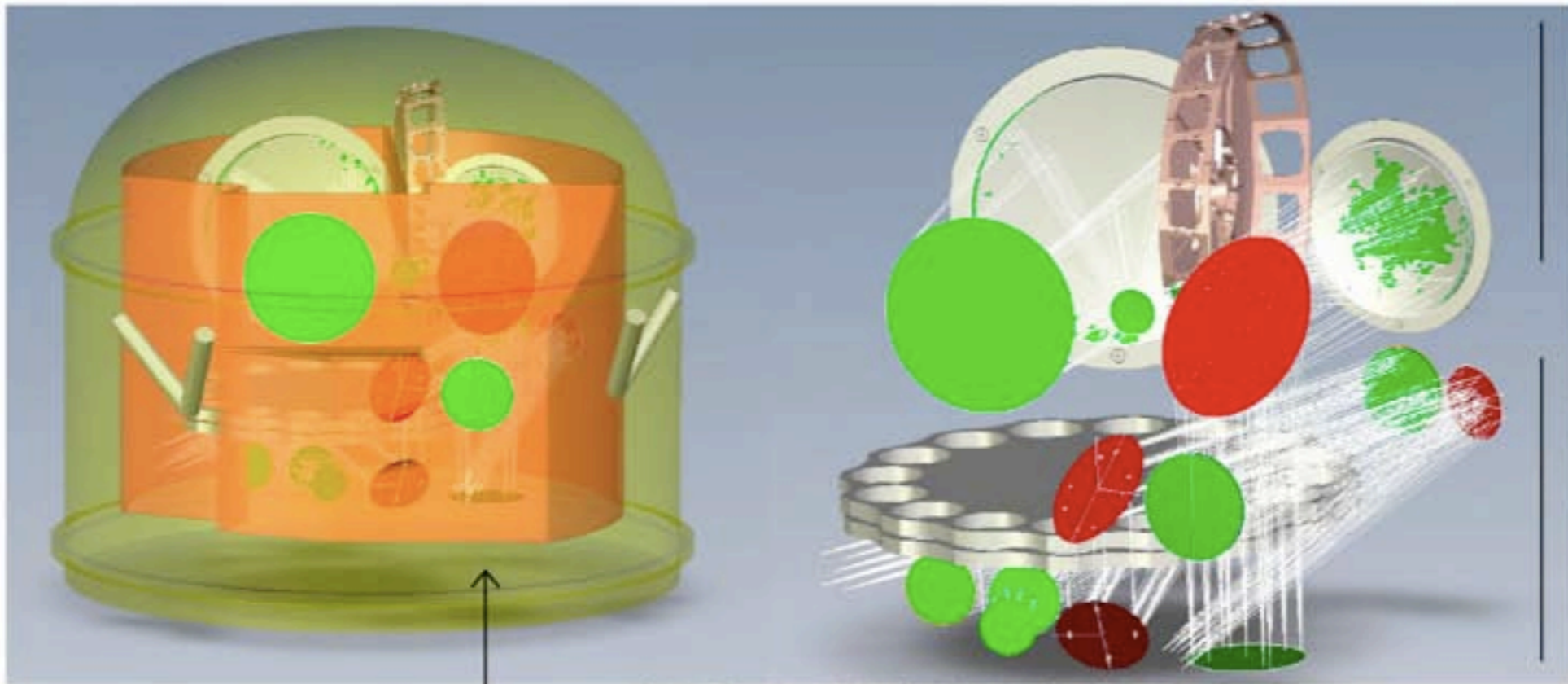

modified Offner relay for high throughput with a single large filter wheel

'Christmas Tree' Arm with 2 large filter wheels and exchangeable fold optics

instrument rotates about this axis, and mounts to the MCAO system MAORY

entrance window





# MICADO

## Crowded Field Photometry: MICADO vs JWST

Resolution gives an effective sensitivity gain – cf. 3mag for MAD vs ISAAC

5-hr K-band simulated exposure

Omega-Cen

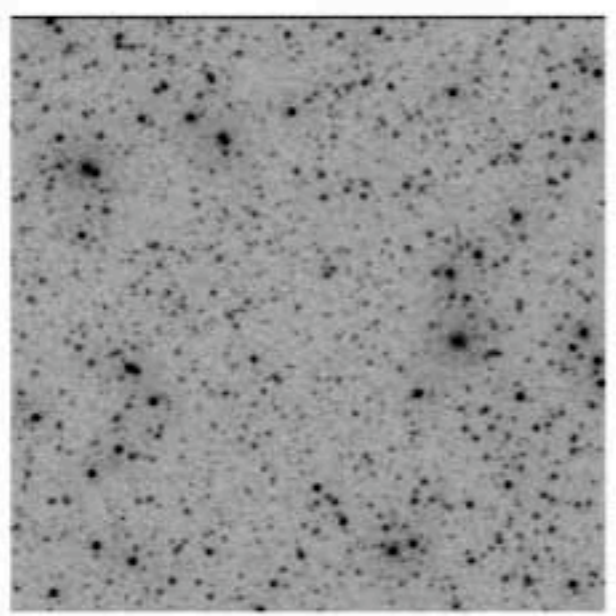

MICADO

MAD

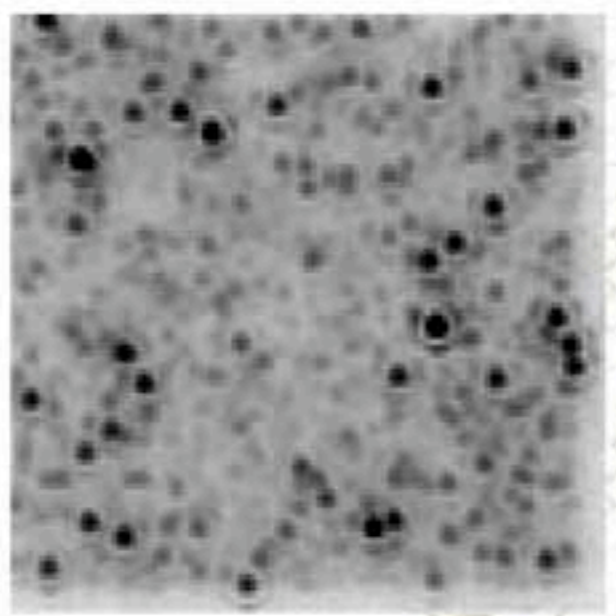
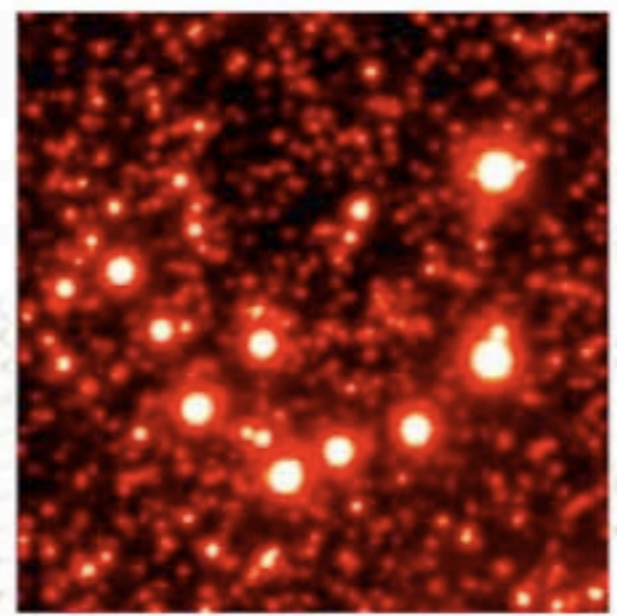

JWST

ISAAC

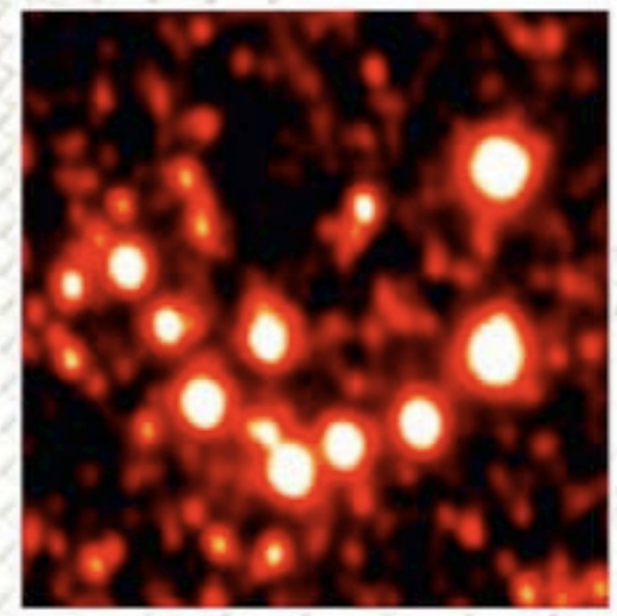







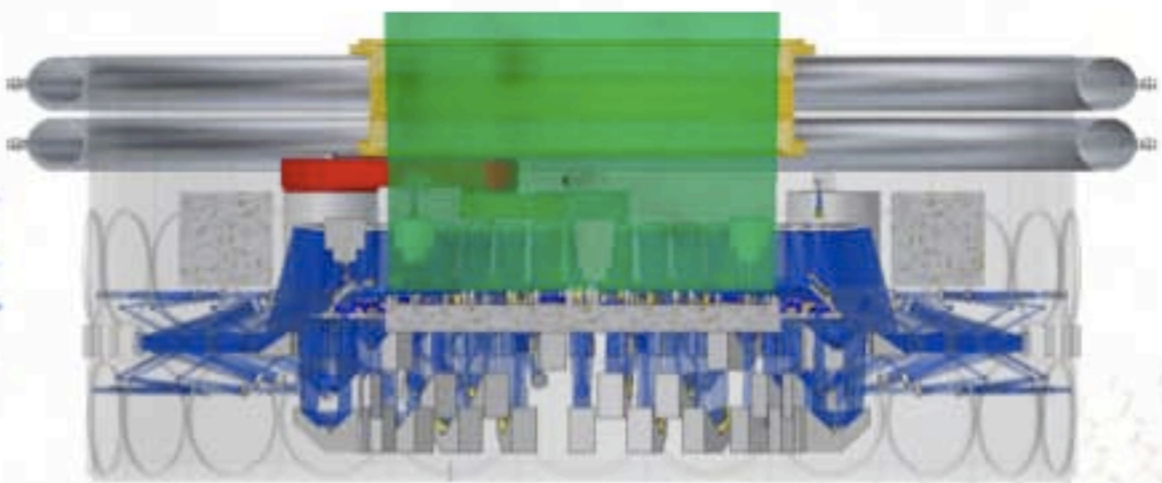
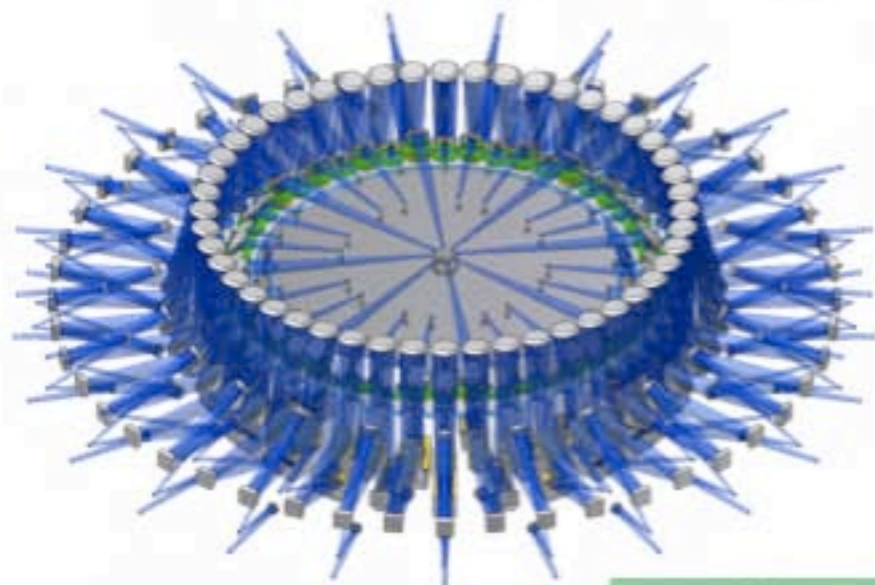
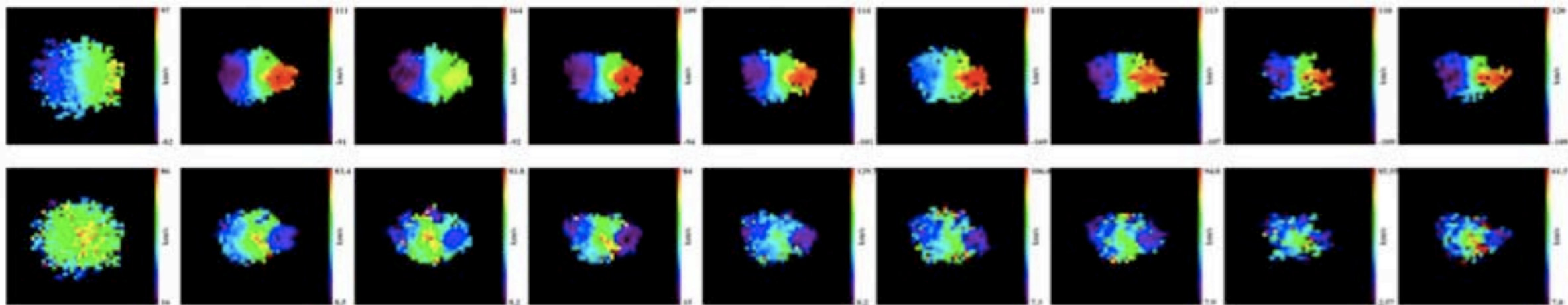

**EAGLE**

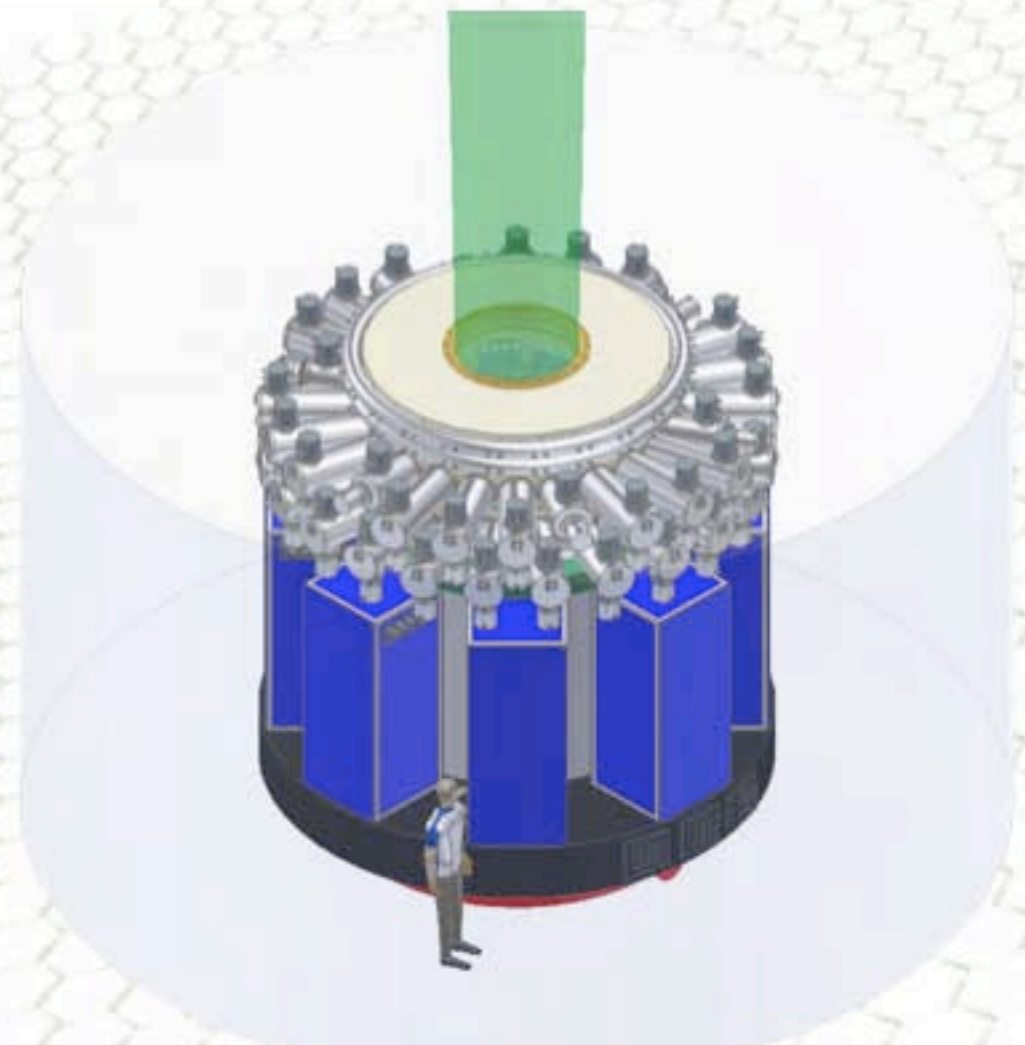
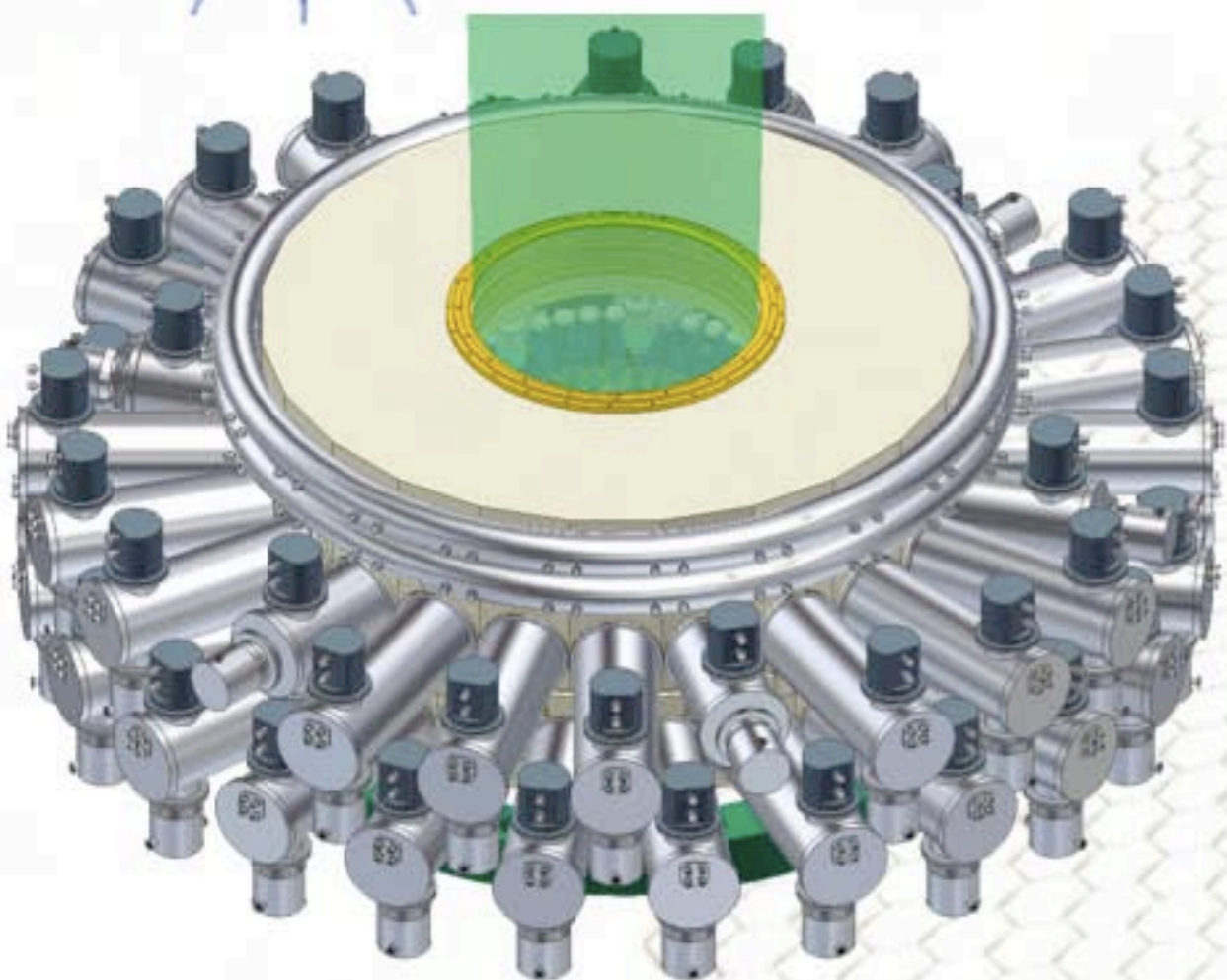





# INSTRUMENT PHASE A MILESTONES

Study	ESO Responsible	K.O. meeting	End Phase I Review	Delivery Final Report	Study Review TBC
EAGLE	Ramsay	27/09/2007	07/07/08	September 2009	October 2009
EPICS	Kasper	24/10/07	24/09/08	January 2010	February 2010
MICADO	Kissler-Patig	20/02/08	11-12/12/08	October 2009	November 2009
HARMONI	Vernet	01/04/08	11/02/2009	November 2009	December 2009
METIS	Siebenmorgen	07/05/08	26/01/09	November 2009	December 2009
CODEX	Pasquini	16/09/08	02/2009	November 2009	December 2009
OPTIMOS	Ramsay	10/2008	06/2009	December 2009	January 2010
SIMPLE	Käufel	10/2008	04/2009	December 2009	January 2010
MAORY	Marchetti	09/11/07	24/10/08	December 2009	January 2010
ATLAS	Paufique	19/09/08	04/09	December 2009	January 2010





# POSSIBLE INSTRUMENT DISTRIBUTION

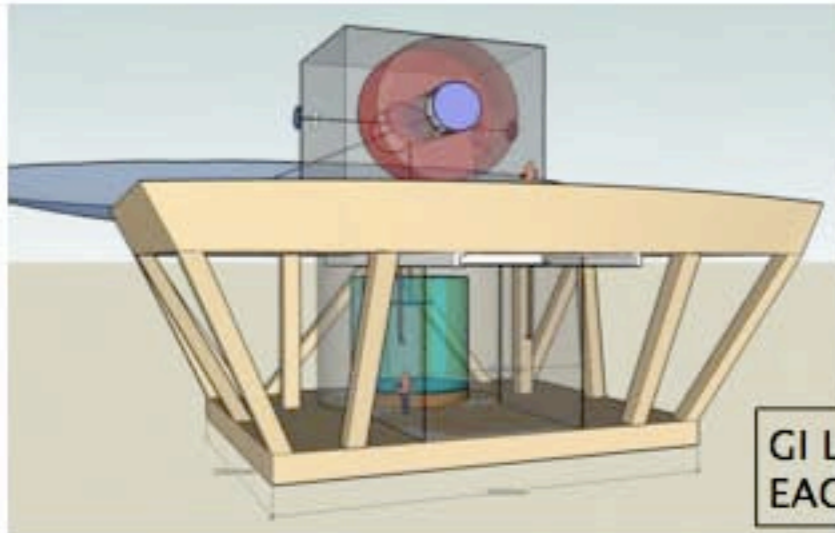
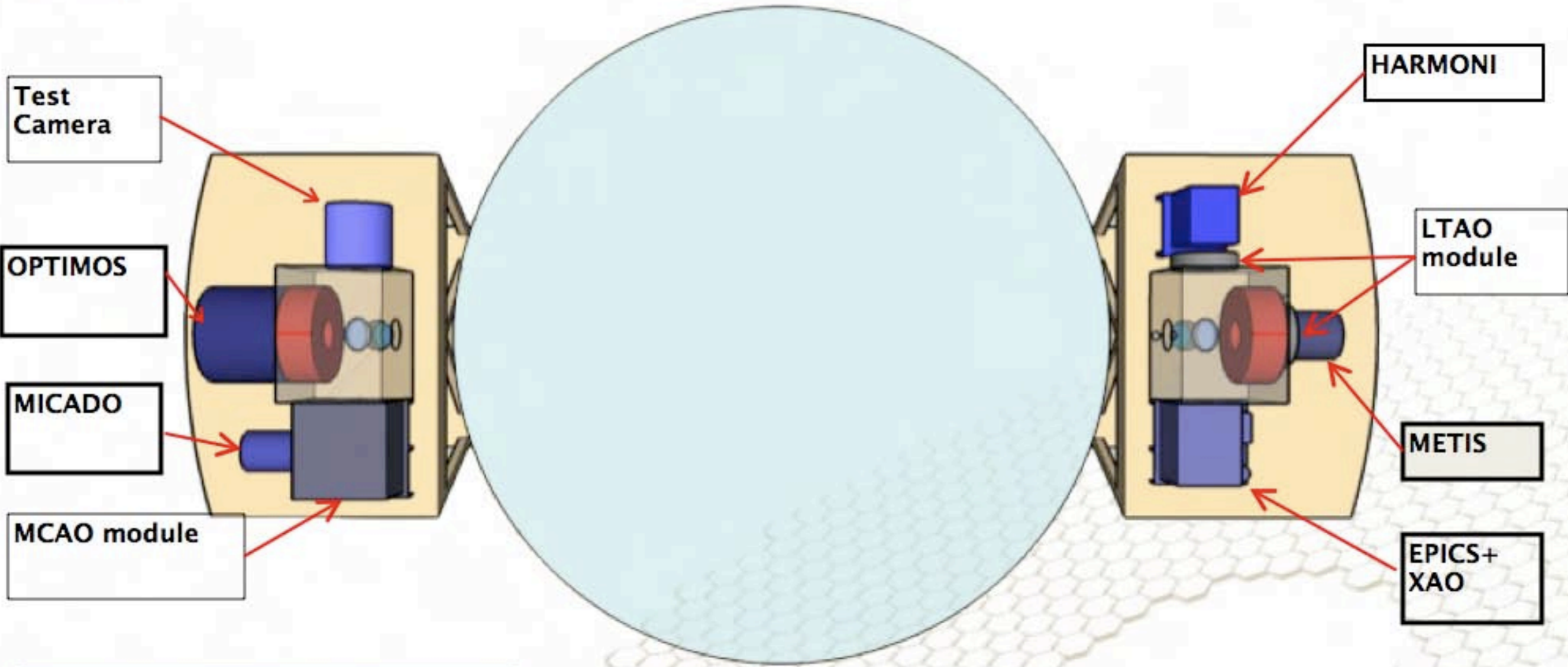

GI Location envisaged EAGLE and SIMPLE



Coudé Location envisaged for CODEX





# LASERS

- 4 laser stations consisting of:
  - 6 laser units of ~25 W ; 4 required for telescope GLAO
  - 4 Launch telescopes of 40cm (30 cm useful aperture)
  - 4 beam relay units beam steering, field selector and beam diagnostic tools compatible with 2 laser beams
  - 4 TBD-m baffles: probably closed tube (TBC)

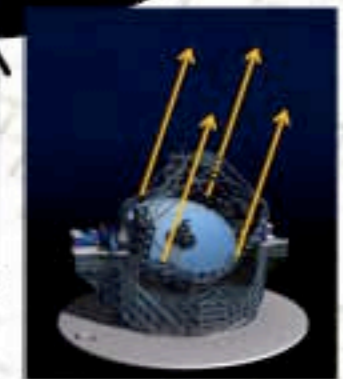
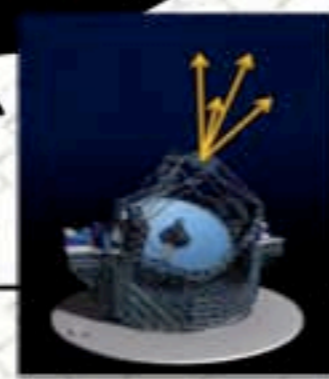
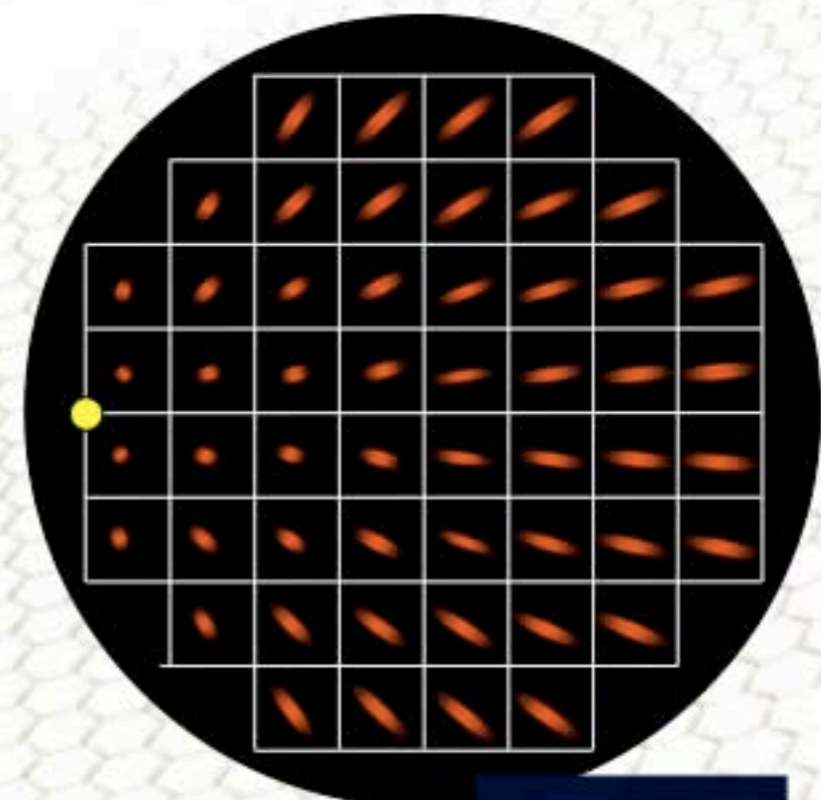
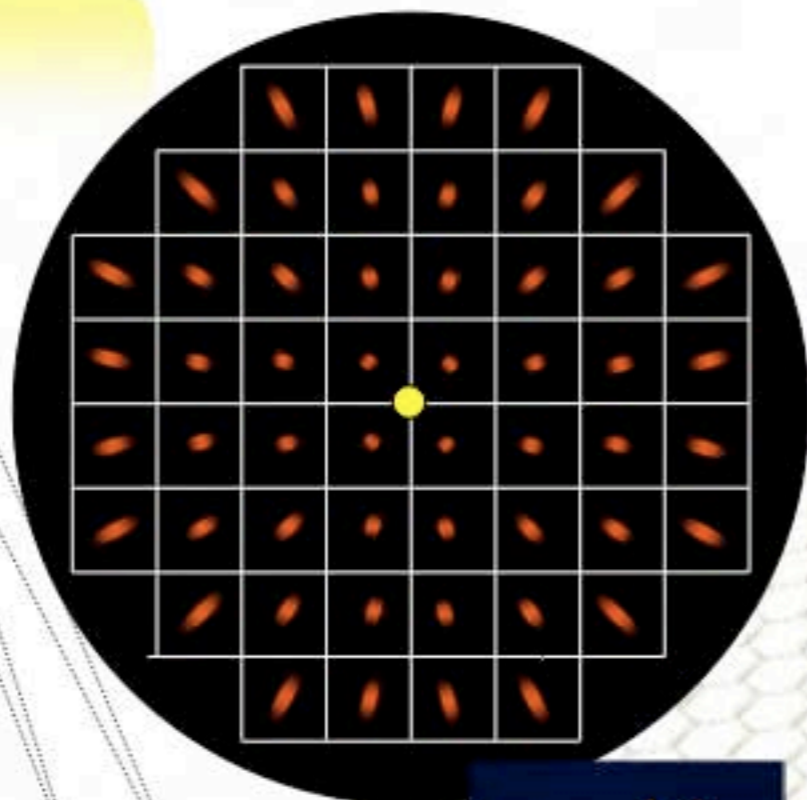
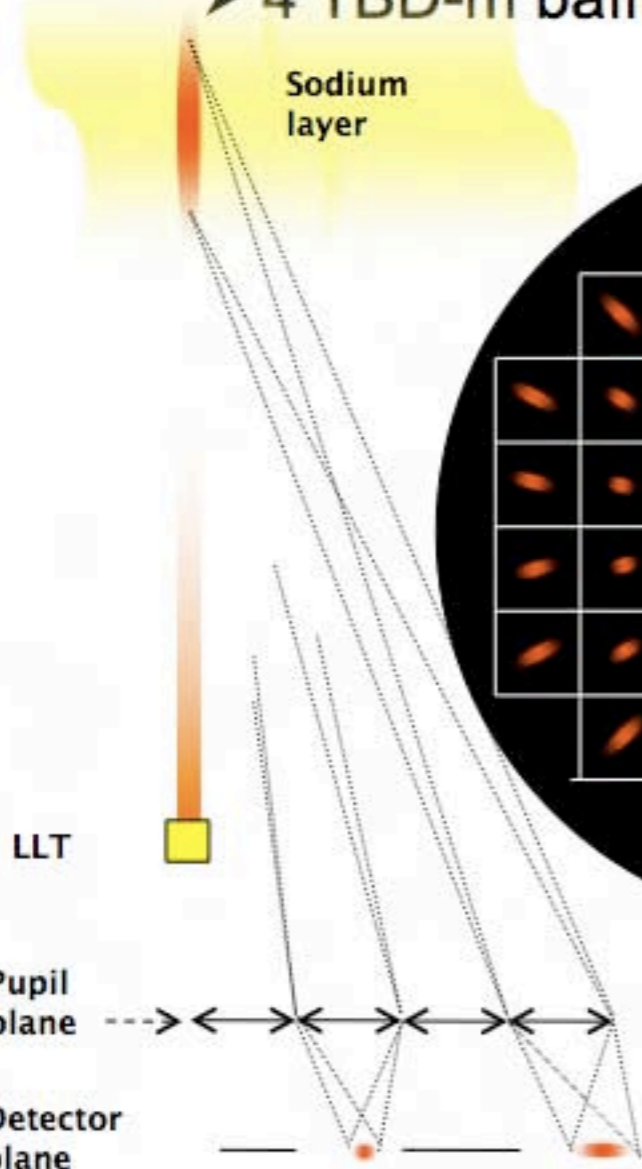
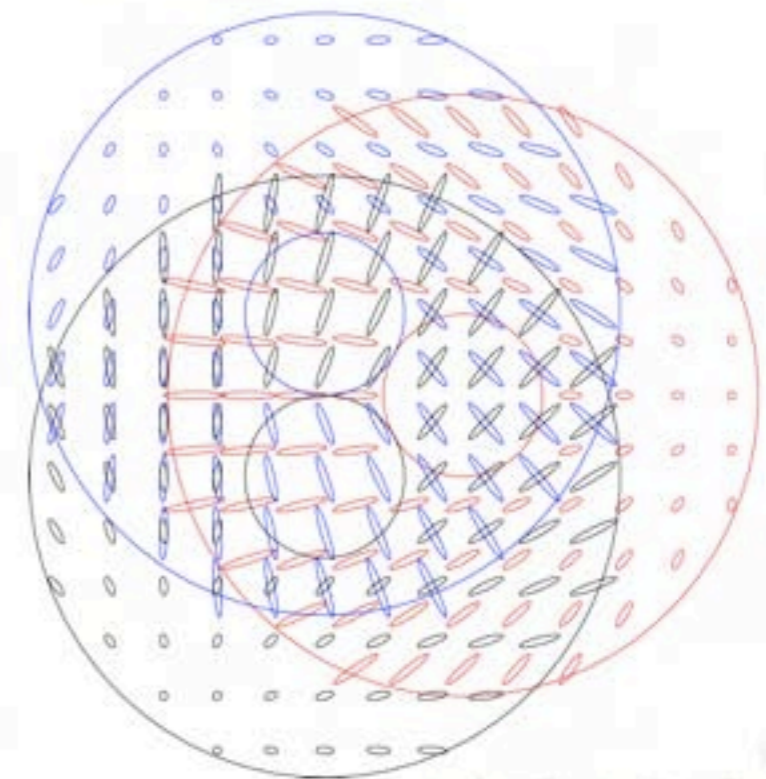





# INFRASTRUCTURE

The infrastructure plan includes:

- 10 km of paved road
- 10 MWatts of local generated power
- Wind turbines
- Water capacity of 500 cubic metres
- Telecommunications in and out of the site
- Accommodation for 100 staff
- Control building and laboratories separated from the dome.
- Temporary accommodation during construction.

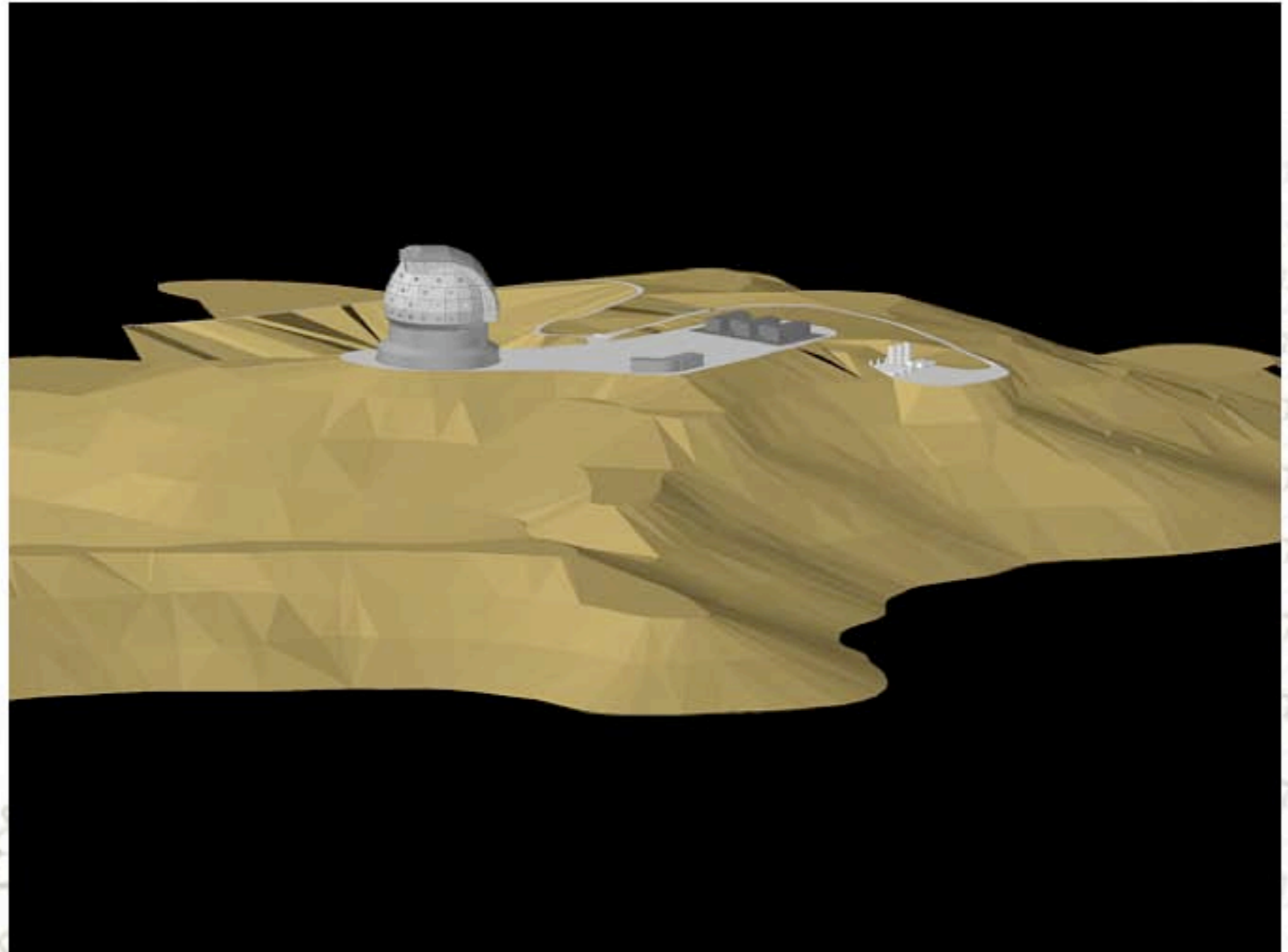





# OPERATIONS

- Science operations modes further developed
  - Service Mode (fully flexible scheduling, without real-time interaction by the user); **[baseline per DRM]**
  - Remote Mode (highly flexible scheduling giving the remotely located user the possibility of interacting with the observatory in real time);
  - Visitor Mode (non-flexible time allocation with the presence of the observer at the facility).
- Developed manpower requirements for observatory
  - based on identified operational and maintenance tasks
- Requirements on telescope (from TLRs), instruments, and operations (SciOps + daily engineering and maintenance activities), and their interfaces, have been consolidated.





# SITE CHARACTERIZATION

SSAC nominated

Selection by end 2009

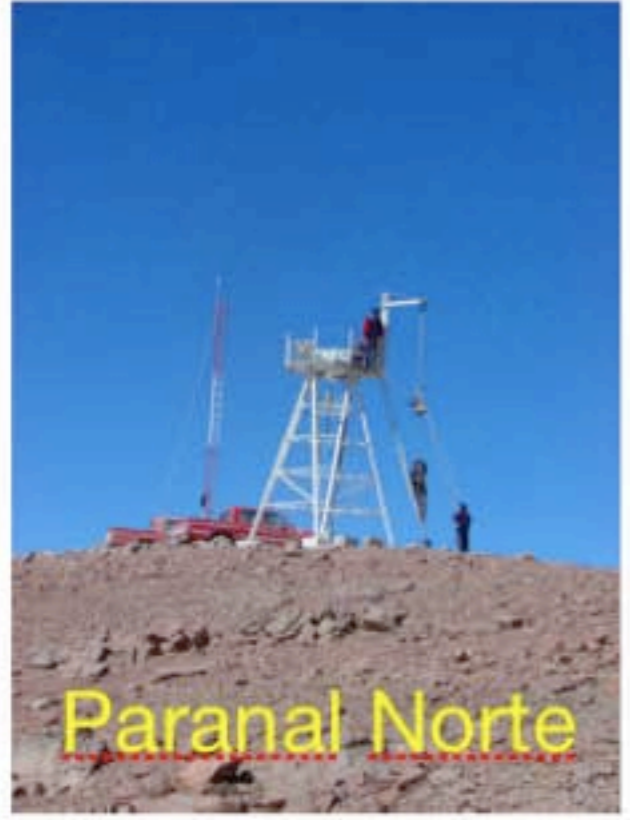

Site characterization on-going for 5 sites







# STATUS OF PHASE B CONTRACTS

- **Preliminary design dome (done)**
  - Delta study doors (done)
  - Wind tunnel (done), detailed CFD (in the pipeline)
- **Preliminary design mount (done)**
  - Delta study interfaces (almost done)
- **Preliminary design primary mirror cell (done)**
  - SOW and TecSpec for prototype units & actuators & edge sensors
- **Preliminary design M2 cell (underway)**
- **Preliminary design M3 cell (underway)**
- **Preliminary design PFS (underway)**
- **Prototype M1 segments (underway)**
  - Two different technologies, 7 segments each
- **Preliminary design/prototypes M4 (2x, underway)**
- **FEED studies (underway)**
  - 2x mainstructure, 2x dome





# CONCLUSIONS

- **The E-ELT is in the detailed design phase**
- **The Phase B is proceeding well**
  - On time and in budget
- **Consolidation with industry:**
  - Mitigation of cost and schedule uncertainties.
  - Subsystem costs from industry within global BRD envelope.
  - Construction timescales for subsystems compatible with global project schedule.
  - 90% of telescope subsystems are already in the industrial study pipeline.
  - Final costing based largely on firm fixed price offers for construction.
- **If approved, construction will take seven years**
  - First light possible in 2018