

NEON Observing School 2008

Introduction to Spectroscopic Techniques (low dispersion)

M. Dennefeld (IAP-Paris)

Outline

- Basic optics of gratings and spectrographs (with emphasis on long-slit spectroscopy)
- Observing steps, and data-reduction
- Other types of spectrographs, and future instrumentation of large telescopes

Principles of gratings (1)

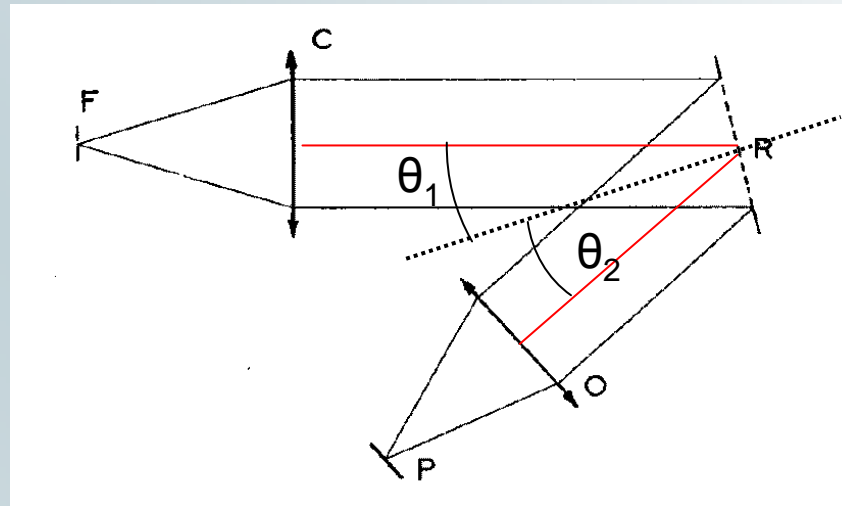

- Grating needs to be illuminated in // beam
- Hence a collimator C and an objective O
- $\sin \theta_2 - \sin \theta_1 = n k \lambda$ (k: order; n: grooves/mm)
- Intrinsic resolution: $\check{R}_0 = n k L$ (L size of grating)
(by definition: $R = \lambda/\Delta\lambda$, with $\Delta\lambda$ the smallest resolvable element)

Principles of gratings (2)

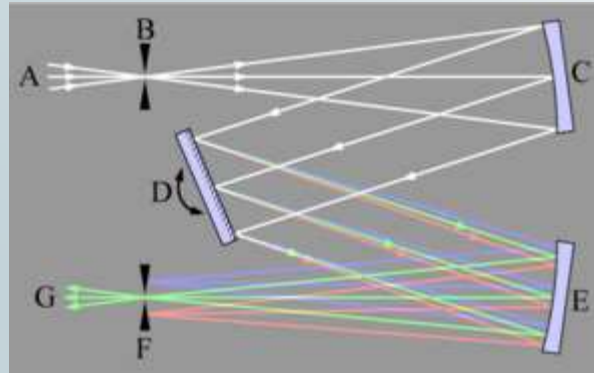

- $a = L \cos \theta_2$ (a : size of exit beam = \emptyset of camera)
- To \check{R}_0 corresponds an exit size (for an infinitely small entrance slit) $d_o = f \lambda / a$ (f : focal length of the camera; diffraction limit of element of size a)
- To be resolved, we need $d_o > 2$ pixels, that is:
 $f/a > 2 X/\lambda$ With $X = \sim 25 \mu$ and $\lambda \sim 0.5 \mu$, this gives:
 $f/a > 50$ ➔ Camera not open enough! (luminosity)
 Conversely, if one wants $f/a \sim 3$, one needs $X = \sim 1 \mu$)
 (remember, pixel was much smaller, $\sim 3\mu$, in photography!)
- Thus will use $d > d_o$, i.e. not use full resolution of grating
- The exit image is optically conjugated to the entrance slit of size l_o !

Match of spectrograph to telescope (1)

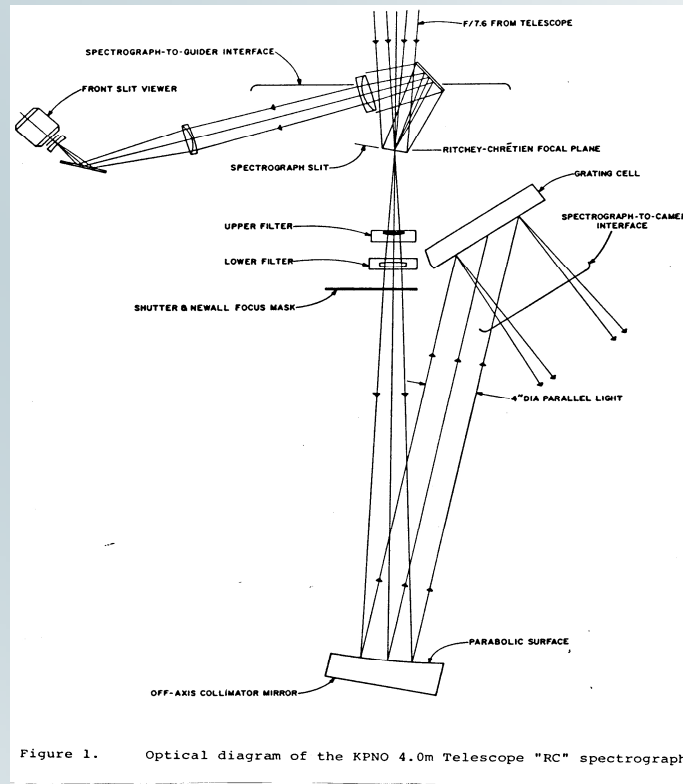

But entrance slit needs also to be matched to telescope and seeing, and opened to increase light throughput.

If you open the entrance slit, you degrade the spectral resolution, i.e. one gets $\check{R} < \check{R}_0 : \check{R} = \check{R}_0 d_0/d$

In addition, one can use a reduction factor in the spectrograph: $d \text{ (exit)} / l \text{ (entrance)} < 1$, (typically 1/6) to minimise size of optics.

Compromise with spectrographs

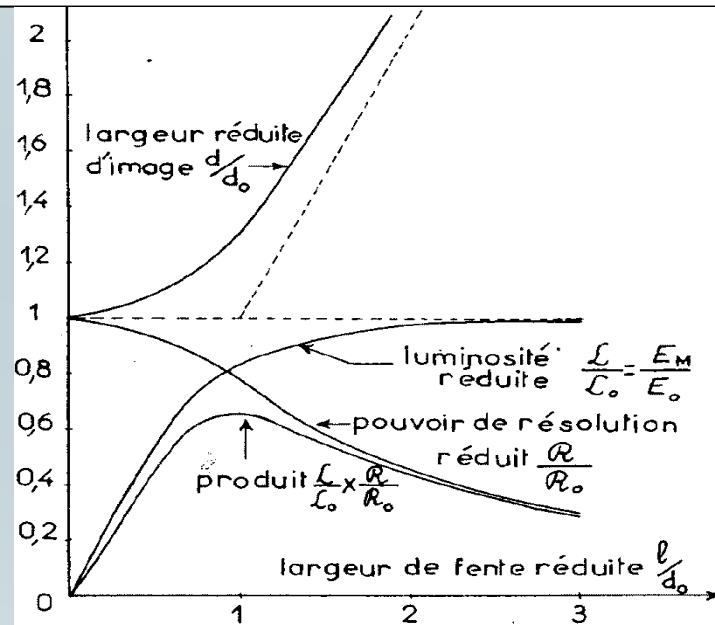

— Influence de la largeur de la fente sur la résolution et la luminosité spectrographique (d'après P. Jacquinot et Ch. Dufour, *J. Rech. Cent. nat. et.*, 2 (1948-1949), 91-103).

- If equal weight given to \check{R} and \check{L} , best choice is for $l/d_0 = 1$ (but then camera not open enough...)
- In astronomy, preference given to \check{L} , so intrinsic resolution is not used.

Match of spectrograph to telescope (2)

- In the focal plane of telescope D , you need:
 - l (width of entrance slit) = $D m_T \alpha$ (α seeing angle)
- Thus $\check{R} = \check{R}_0 d_0 / d = \check{R}_0 \cdot f \lambda / a \cdot 1/d \sim \check{R}_0 \lambda / \alpha \cdot 1/D$
that is for a given \check{R} , the size of the grating (which governs \check{R}_0) is proportional to D !

This is a problem for large telescopes!

- Full formula is:
 $\check{R}\alpha = 2 L/D \operatorname{tg}\beta [\cos\theta_2/\cos\theta_1]$ (anamorphism)
 $\check{R}\alpha$ is the « efficiency » of the system
- β blaze $\sim \theta_2$
 - « R2 » grating: $\operatorname{tg}\beta = 2$ (63°)
 - « R4 » grating: $\operatorname{tg}\beta = 4$ (75°)

Application: VLT

Photon-starved Mode

- $D = 8$ m Telescope diameter
- $0.5 \mu\text{m}$ seeing = $0''.65$ -median; $0''.3$ -10%
- $p = 12 \mu\text{m}$ $(4\text{k})^2$ V/NIR pixels (market)
- F/ω Camera: $\omega \geq 1.4$; $L \geq 80$ mm (optics)
 $\Rightarrow \alpha_{\text{sky}} = 0''.44$ (2-pixel sampling)

sampling ~ OK; A.O. correction optional

Grating diameter L ; on-sky slit width α

$$\Rightarrow \mathfrak{R}\alpha = \lambda/\delta\lambda = 2(L/D) \tan \varphi$$

$L = 80$ mm; $\tan \varphi = 1 \Rightarrow \mathfrak{R}_{1''} = 4 \cdot 10^3$ (FORs)

$L = 200$ mm; $\tan \varphi = 4 \Rightarrow \mathfrak{R}_{1''} = 4 \cdot 10^4$ (UVES)

image slicers not always required

Camera

$$\omega = 1.4$$

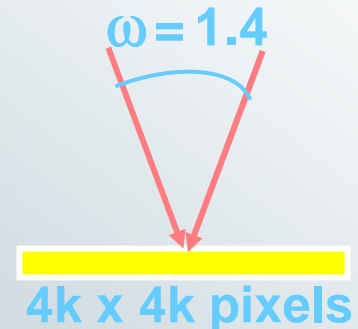

$$\alpha D \approx p\omega$$

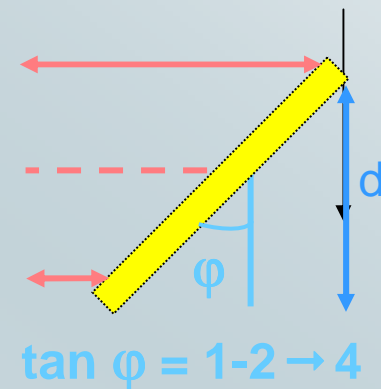

Littrow

Order superposition

- At given θ_2 (i.e. on given pixel of detector), $k \lambda = \text{cste}$

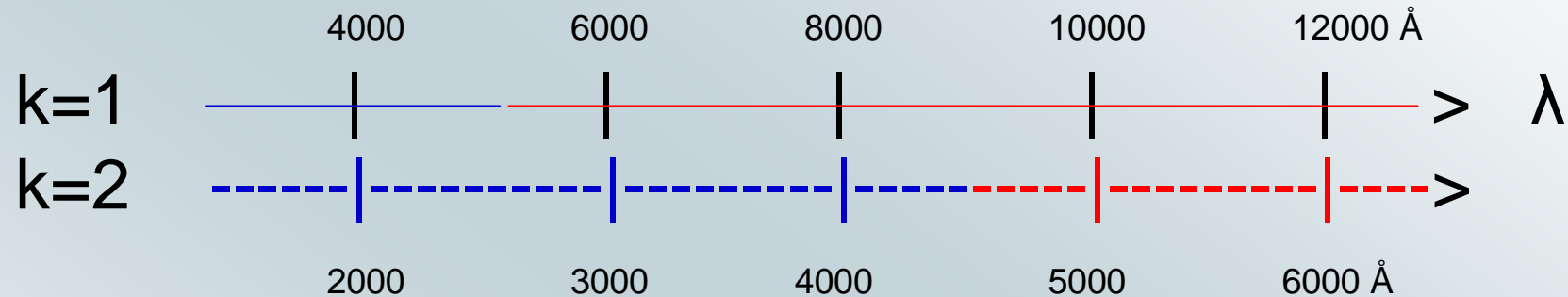

e.g. first order red is superposed by 2. order blue.

- Use of filters to separate orders (high-pass red (cutting the blue) in the above example)
- If one wants **higher dispersion**, go to higher orders (e.g. $k \sim 100$). But **overlap of orders then unavoidable** (λ shift between orders too small to use filters as separators), so one needs cross-dispersion to separate orders.

Echelle spectroscopy

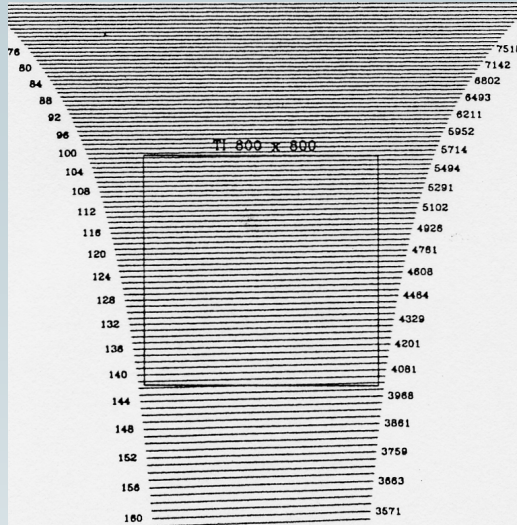

Wavelength ---->



Spatial
direction

... and order spacing,
for sky or background
subtraction
(here HIRES at Keck)

Compromise between
resolution, detector size,
.....
(here Hamilton spectr. at Lick)

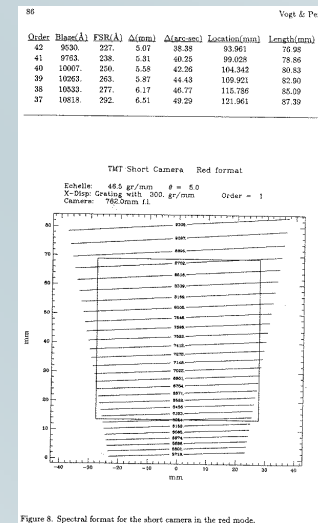
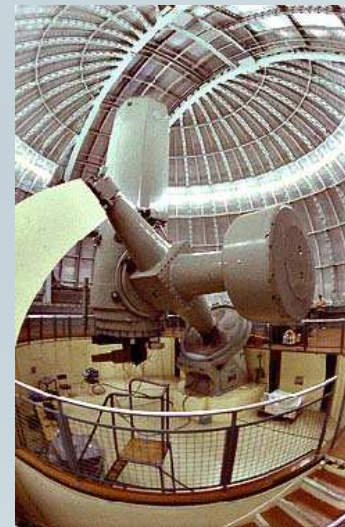

Figure 8. Spectral format for the short camera in the red mode.

Example of long-slit spectroscopy

- Several available:
 - IDS at INT in LaPalma
 - Carelec at OHP
 - Former B&C at 1.52m at LaSilla
 - Long-slit mode in EFOSC types, etc...
- Typically a few arcmin long slit, adjustable width and orientation



Slit losses

- A rectangular slit does not let through all energy from a circular seeing disk! (but is better than circular aperture)
- For standard stars observations, open wide the slit if you want absolute photometry!

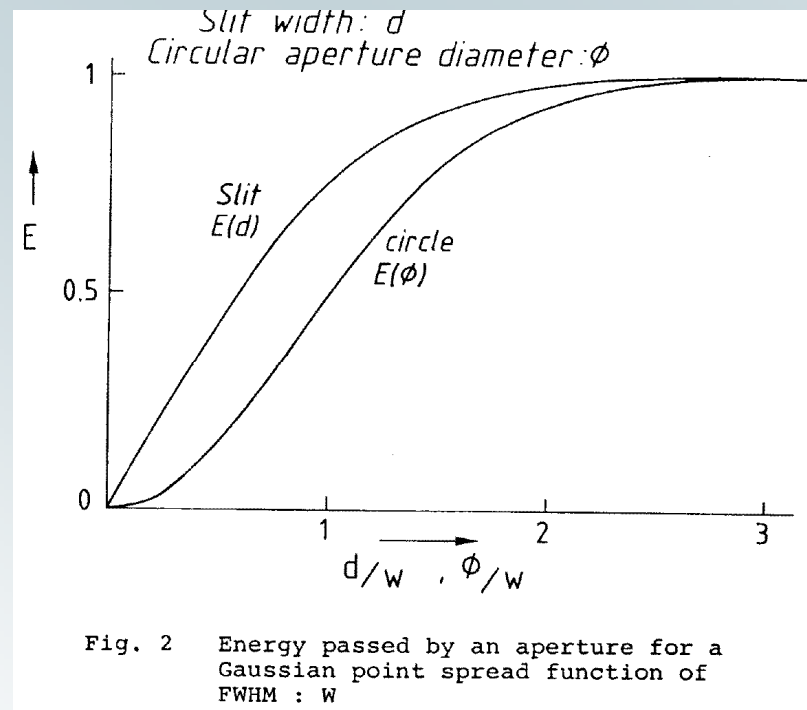

Differential refraction

- $\Delta R(\lambda) = R(\lambda) - R(5000\text{\AA}) \sim \text{cste} [n(\lambda) - n(5000)] \tan z$
Ex: for AM = 1.5, $\lambda=4000\text{\AA}$, $\Delta R \sim 0.70''$: relative loss of flux
Depends on P and T (altitude) and humidity
Worse in the blue, negligible in the near-IR
- Use parallactic angle for slit (oriented along the refraction)
(see diagram, after Filippenko, PASP, 1982)



Venus (from J. Zhu)

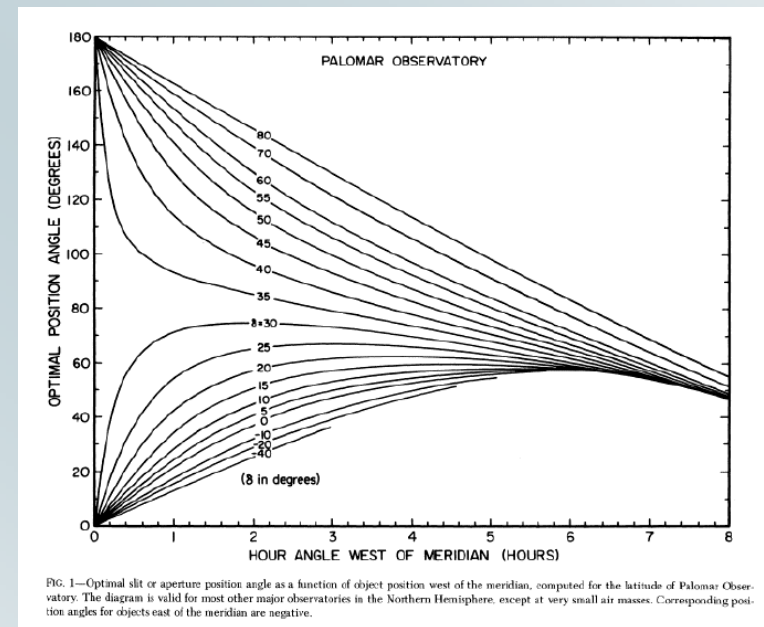

Blazed gratings

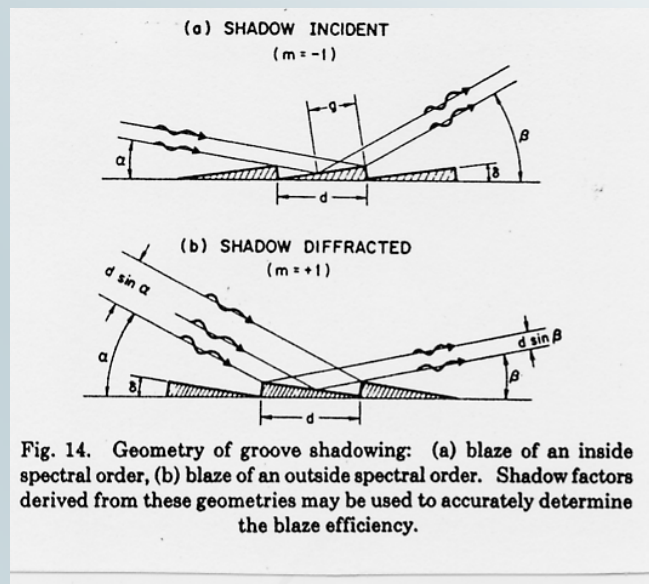

- Blaze angle (δ) chosen such that max. of interferences coincides with max. of diffraction in the selected order
- Some shadowing occurs at large incidence angles, reducing a bit the efficiency

Grating Efficiency

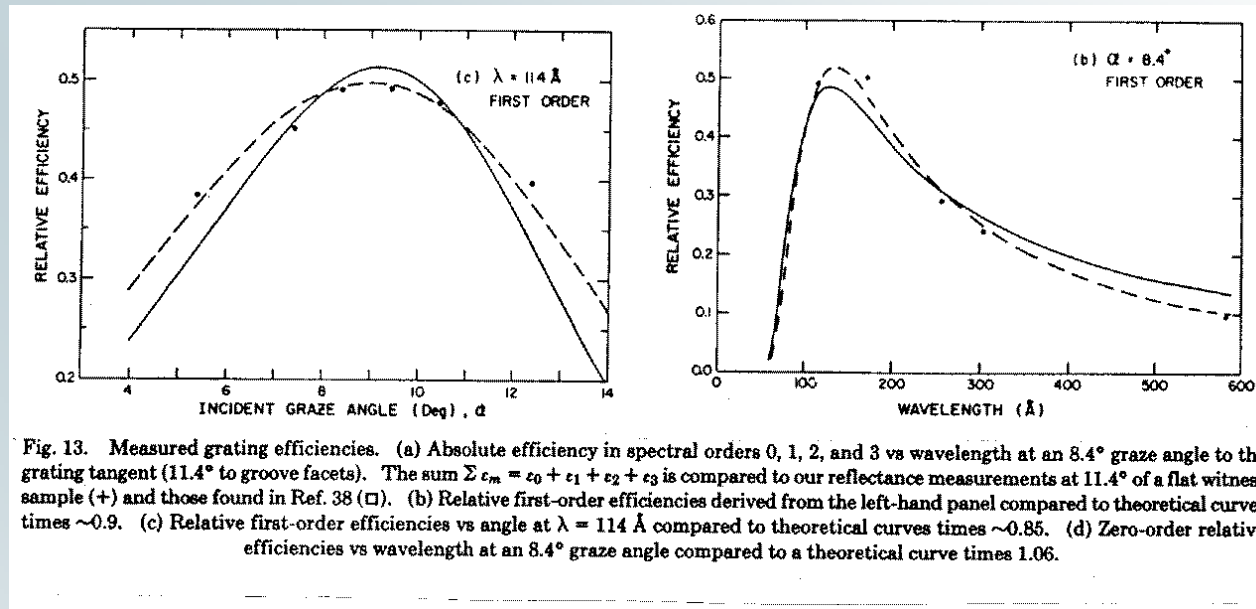

- Blazed gratings are efficient close to blaze angle
- Choose grating according to wished wavelength range
- Keeping in mind that efficiency drops sharply bluewards of blaze, but slowly redwards of it: thus blaze λ should be bluewards of your wished central wavelength !!

Flat Field correction

- To correct the high spatial- frequency variations across the image/spectrum
- Origin of variations: pixel to pixel sensitivity variations (detector); transmission variations of optics (or dust particles...)
 - It is a multiplicative or « gain » effect
- Illuminate with a uniform (« flat ») source and use the same optical path as the astronomical source....Difficult because at infinity!
- Need a high S/N not to degrade the science exp.
- Dome flats or internal calibration lamps not at infinity...correction approximate but flux OK
- Sky flats better, but not possible in spectroscopy (not enough signal), only for imaging
- There is an extra additive component due to night sky (emission lines) fringes....

Flat Field correction (2)

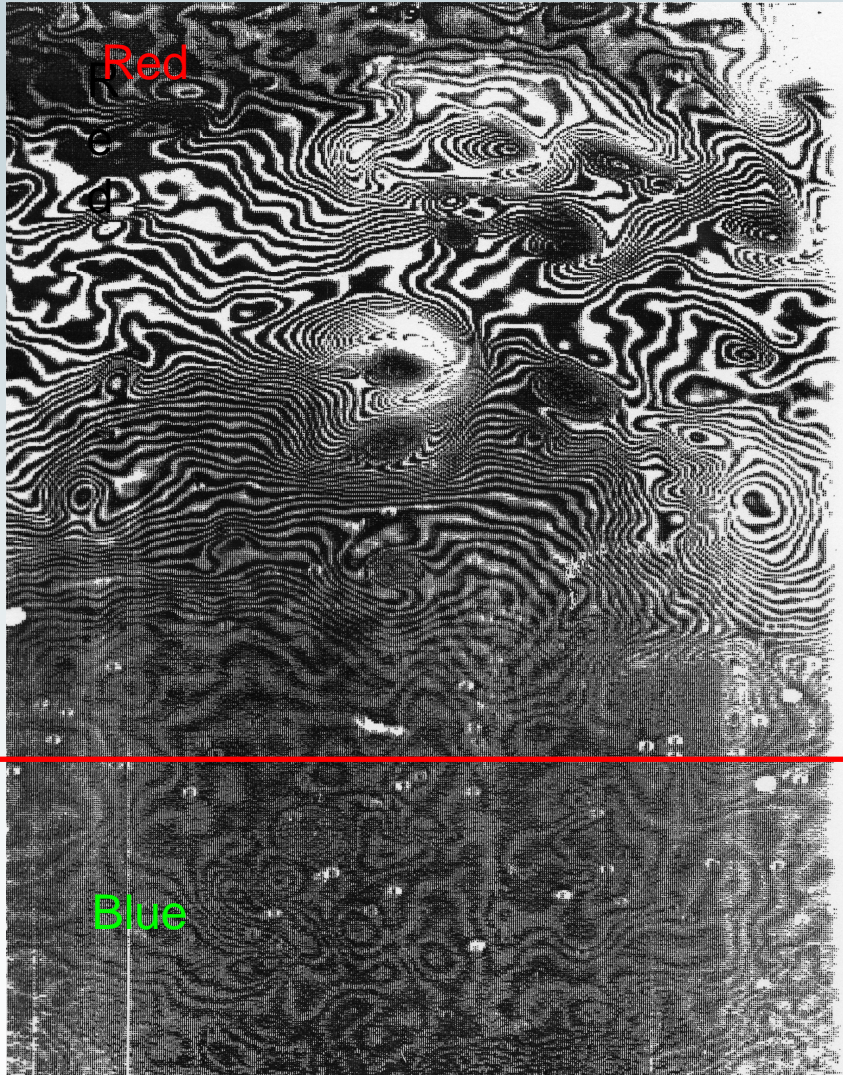

- FF is wavelength dependant: to be done through whole spectrograph
- Needs to be normalised to 1 to conserve fluxes
- One can correct vigneting along the slit length if FF illumination is correct (usually not the case with dome flats)

Sky emission

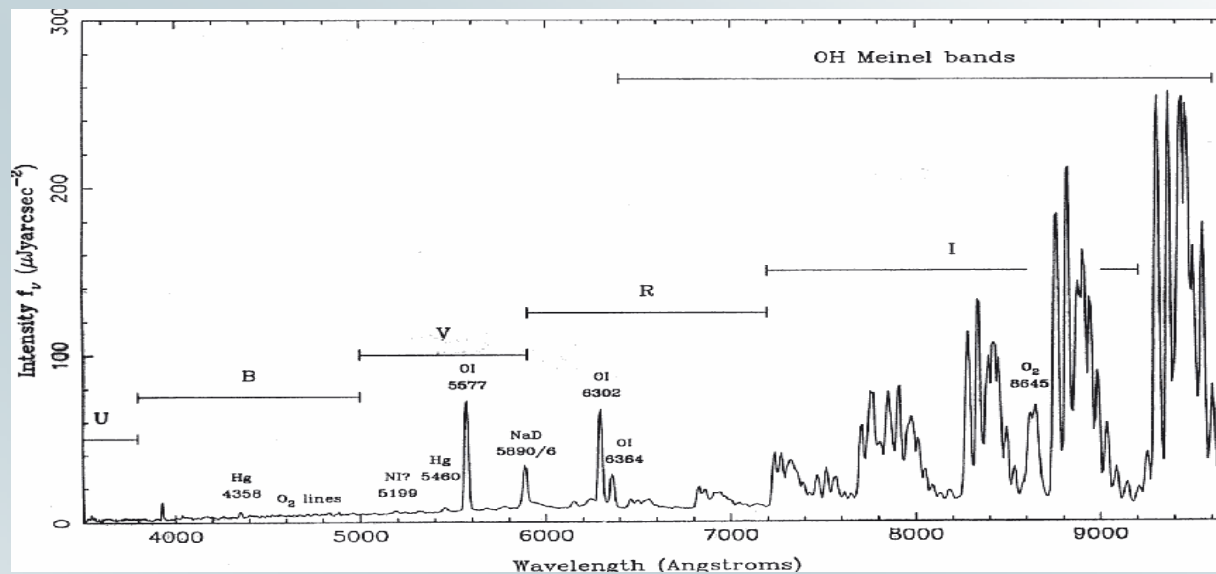

(from Massey et al. 1990)

- Sky is bright, specially in near-IR !!
- Needs to be subtracted
- Requires a linear detector

Importance of sky subtraction

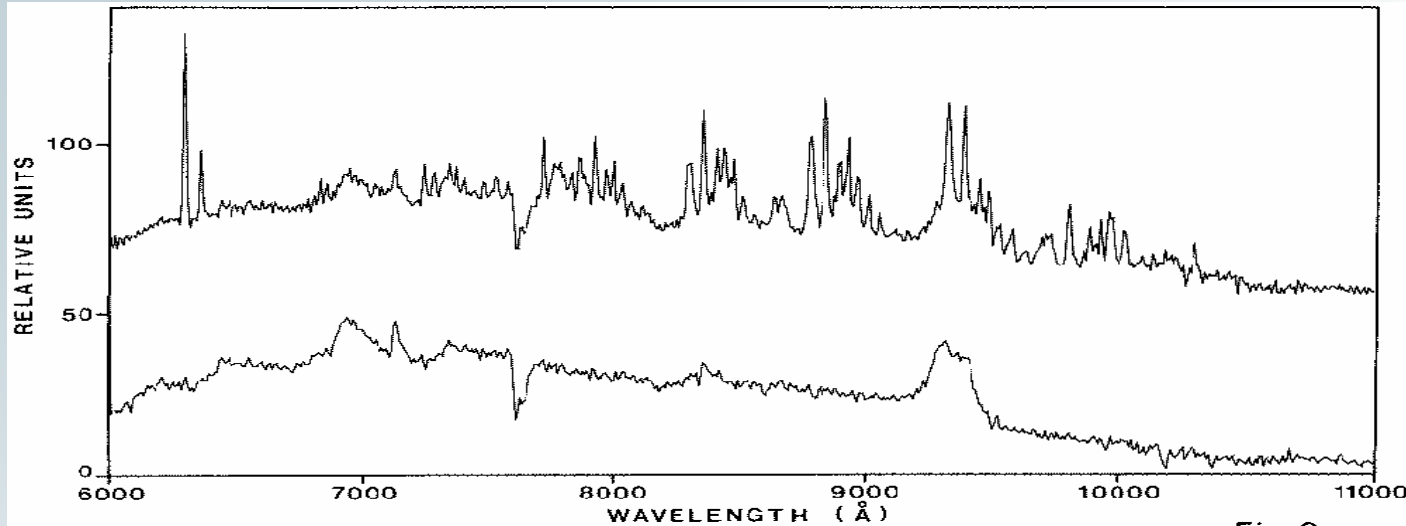

Example of a $V=16.5$ QSO in the far-red
(that is almost as bright as the full moon...)

Obtained with the ESO 3.6m and Reticon diode array

Top: full spectrum Bottom: sky subtracted

The important features (broad Balmer lines) are completely hidden in the OH night sky lines...

Becoming worse when going to the near-IR (J, H, K bands)

Atmospheric absorptions

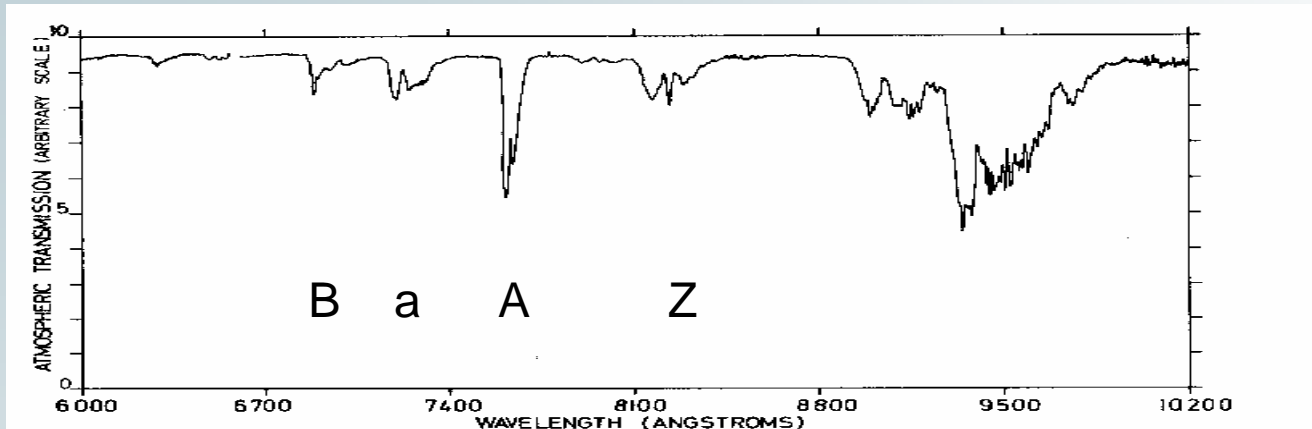

FIGURE 1. — Atmospheric absorption between 6000 Å and 10200 Å as seen with the instrument used for the observations. This figure has been obtained by dividing the spectrum of a standard star observed with an air mass of 2.88 by the spectrum of the same star obtained with an air mass of 1.06.

from Vreux, Dennefeld & Andrillat (1983)

- Due to O_2 (A, B, ..) and H_2O (a, Z, ..) in the visible, plus CO_2 , CH_4 , etc... in the near-IR
- Not to confuse with stellar absorption bands...
- To correct: needs to observe a hot star (no intrinsic absorption lines) in the same conditions (similar airmass) and divide the object's spectrum by the hot star's spectrum. Saturated lines (A,...) are difficult to correct completely.
- The A, B, notation comes from Fraunhofer (1814, solar spectrum)

Standard stars (1)

Southern spectrophotometric standards for large telescopes – II 243

MIT 'Mascot' CCD system. The reduction procedure used a rough flux calibration which introduced some small-scale wiggles into the energy distributions, so the spectra should be used only as guides to the general continuum shape and to the locations of strong absorption lines.

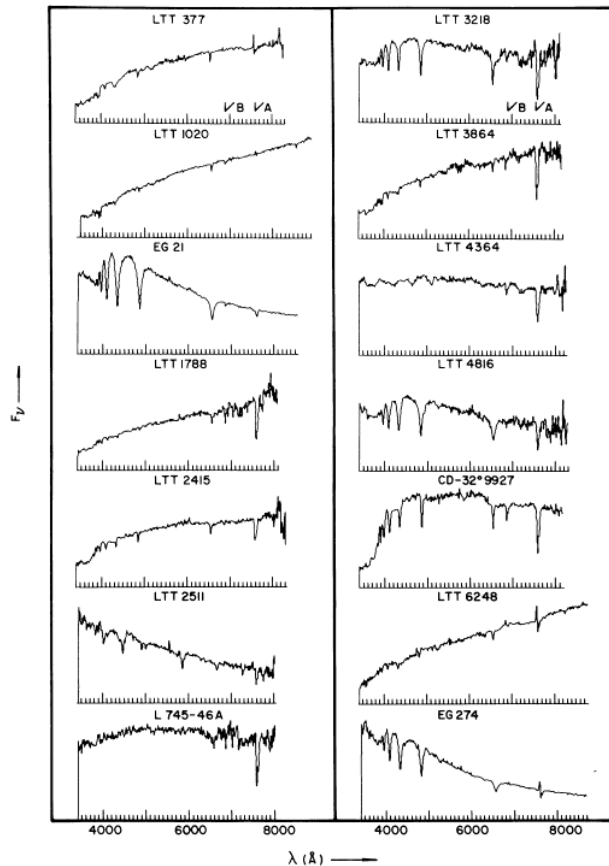

Figure 1. Standard star spectra. The positions of the atmospheric A and B absorption bands are marked.

© Royal Astronomical Society • Provided by the NASA Astrophysics Data System

Example from Baldwin
& Stone (1984)

Choose Standard with
appropriate Spectral
Energy Distribution
With as few absorption
lines as possible
WD's are ideal, but
faint...

Standard stars (2)

242

J. A. Baldwin and R. P. S. Stone

Table 1. Magnitudes per unit frequency interval ($\text{mag} = -2.5 \log f_\nu - 48.595$). Numbers in roman type are scanner data with standard deviations of the mean in parenthesis; italicized numbers are interpolated SIT/CCD data with standard deviations of single observations in parenthesis. Bandpasses are 80 Å.

λ	LTT 377	LTT 1020	EG 21	LTT 1788	LTT 2415	LTT 2511	L745-46A	LTT 3218	LTT 3864
6056	11.13(0)	11.38(0)	11.53(0)	13.04(1)	12.13(1)	14.01(2)	13.02(2)	11.89(1)	12.04(1)
6180	11.12(0)	11.35(1)	11.55(1)	12.99	12.10(1)	14.01(2)	13.01	11.92(0)	12.07(5)
6310	11.09(0)	11.34(2)	11.61(1)	12.96	12.09(2)	14.06(5)	13.02	11.85(0)	12.01(6)
6436	11.09(0)	11.30(1)	11.48(2)	12.98	12.08(2)	14.11(4)	13.05	11.94(0)	12.09(6)
6640	11.08(1)	11.26(5)	11.81(3)	13.03	12.11(2)	14.21(1)	13.09	12.24	11.99(1)
6790	11.06(1)	11.26(1)	11.71(1)	12.97(1)	12.06(1)	14.15(2)	13.03(2)	11.98(2)	11.98(1)
7160	11.04(0)	11.23(2)	11.77(1)	12.92(1)	12.06(1)	14.23(4)	12.95	12.96(4)	11.95(2)
7250	11.04(5)	11.23(7)	11.82(5)	12.97(1)	12.06(6)	14.24(6)	13.08	-----	11.96(5)
7400	11.07(2)	11.22(4)	11.84(3)	12.93(2)	12.08(1)	14.30(1)	13.08	11.99(1)	11.94(4)
7550	11.03(1)	11.20(1)	11.86(1)	12.92(1)	12.04(1)	14.28(4)	13.11(1)	12.03(1)	11.93(1)
7780	11.02(1)	11.16(2)	11.90(1)	11.87(1)	12.03(1)	-----	13.12(1)	12.04(1)	11.91(1)
7890	11.01(3)	11.16(1)	11.91	12.89(6)	12.00(2)	-----	-----	-----	11.93(2)
7990	11.01(1)	11.15(1)	11.94	12.85(1)	12.00(1)	-----	-----	-----	11.93(0)
8090	10.98(1)	11.13(1)	11.94(2)	12.85(2)	11.98(1)	-----	13.13(1)	12.04(1)	11.89(1)
8180	-----	11.13(1)	11.96	-----	-----	-----	-----	-----	-----
8280	-----	11.13(1)	12.00	-----	-----	-----	-----	-----	-----
8370	11.01(2)	11.12(2)	12.00(0)	12.04(2)	12.00(2)	-----	13.12(0)	12.11(2)	11.89(1)
8708	10.97(2)	11.08(1)	12.06(1)	12.80(1)	11.96(2)	-----	13.16(1)	12.10(1)	11.87(1)
9812	10.96(2)	11.05(2)	12.18(2)	12.81(1)	11.93(0)	-----	13.23(3)	12.23(2)	11.87(2)
10256	10.98(3)	11.08(2)	12.25(1)	-----	11.93(1)	-----	-----	12.33(5)	11.88(1)
10400	11.02(3)	11.13(2)	12.28(2)	-----	11.95(1)	-----	-----	12.30(3)	11.94(1)

λ	LTT 4364	LTT 4816	CD-32* 9927	LTT 6248	EG 274	LTT 7379	LTT 7987	LTT 9239	LTT 9491
6056	11.50(0)	13.85(0)	10.41(1)	11.67(1)	11.21(1)	10.08(1)	12.37(0)	11.92(1)	14.19(1)
6180	11.51(2)	13.89(2)	10.42(1)	11.65(4)	11.24(2)	10.08(4)	12.39(4)	11.91(2)	14.18(1)
6310	11.52(3)	13.97(5)	10.44(6)	11.64(4)	11.30(2)	10.05(4)	12.44(4)	11.89(5)	14.20(3)
6436	11.52(7)	13.94(4)	10.43(2)	11.62(1)	11.33(2)	10.01(1)	12.50(5)	11.83(2)	14.19(5)
6640	11.53(2)	14.12(0)	10.48(0)	11.65(2)	11.47(1)	10.01(2)	-----	12.81(4)	14.04(5)
6790	11.53(0)	14.01(4)	10.45(1)	11.61(0)	11.40(1)	9.97(1)	12.53(1)	11.78(1)	14.29(3)
7100	11.53(2)	14.04(1)	10.45(2)	11.59(1)	11.46(6)	9.95(2)	12.60(3)	11.74(3)	14.27(6)
7250	11.61(7)	14.16(3)	10.50(6)	11.60(4)	11.54(4)	9.97(8)	12.64(4)	11.71(4)	14.40(1)
7400	11.56(2)	-----	10.46(5)	11.59(2)	11.54(2)	9.95(5)	12.68(6)	11.70(5)	14.39(1)
7550	11.58(1)	14.17(1)	10.49(1)	11.56(1)	11.60(1)	9.93(1)	12.72(2)	11.70(1)	14.39(3)
7780	11.61(1)	14.13(2)	10.51(1)	11.52(0)	11.65(0)	9.91(1)	12.72(1)	11.69(1)	14.41(1)
7890	11.58(6)	-----	10.50(1)	11.51(1)	11.66(7)	9.89(3)	12.76(2)	11.68(2)	-----
7990	11.63(2)	-----	10.52(0)	11.50(1)	11.73(2)	9.90(1)	12.76(1)	11.68(2)	-----
8090	11.64(1)	14.09(2)	10.52(1)	11.48(0)	11.71(0)	9.89(1)	12.79(2)	11.65(1)	-----
8180	-----	-----	10.52(2)	11.48(2)	11.74(2)	9.88(3)	12.81(2)	11.66(2)	-----
8280	-----	-----	10.54	11.50(1)	11.76(0)	9.90(2)	12.80(0)	11.61(4)	-----
8370	11.67(1)	14.19(1)	10.54(1)	11.49(1)	11.79(1)	9.88(0)	12.84(2)	11.64(1)	14.45(1)
8708	11.69(1)	-----	10.54(1)	11.46(1)	11.85(0)	9.87(1)	12.90(1)	11.61(1)	-----
9812	11.81(1)	-----	10.55(1)	11.45(1)	12.04(0)	9.85(1)	13.03(2)	11.55(0)	-----
10256	11.87(1)	-----	10.61(1)	11.49(0)	12.18(2)	9.89(1)	13.12(5)	11.56(1)	-----
10400	11.89(1)	-----	10.62(1)	11.50(2)	12.19(2)	9.90(1)	13.19(1)	11.59(1)	-----

In contrast to our earlier results, we emphasize that all of the SIT/CCD points are now interpolated. The elimination of any extrapolation should significantly improve the accuracy of the calibration in the region λ 7780–8280.

For completeness, Table 1 includes the previous scanner results for λ 6056 and 6790. The new scanner observations have been combined with the old ones where they overlapped at λ 7550. Generally the agreement between the two data sets was excellent, so those values are little changed.

For the three stars which are faintest in the red our results do not extend all the way to λ 10400. In addition, the two longest wavelength points were discarded for two other stars because of excessively large internal errors.

Fig. 1 shows spectra of the 18 new standards and of nine standard stars from the list of Stone (1977). The observations were made with the CTIO SIT-Vidicon systems and with the

© Royal Astronomical Society • Provided by the NASA Astrophysics Data System

Check that:

- The sampling is appropriate
- The wavelength range covers your needs (carefull in the far-red...!)

Wavelength calibration

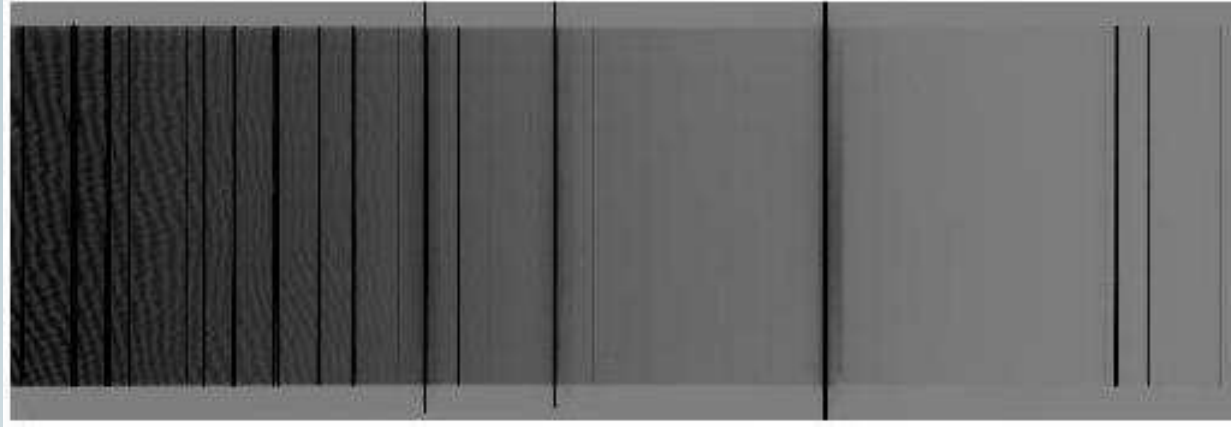

- This image is a raw (He + Ar) exposure
- You may need to saturate some of the lines...
- 2D wavelength calibration (line by line) will also correct the distortion
- If CCD well aligned, 1D calibration may be enough

Wavelength calibration (2)

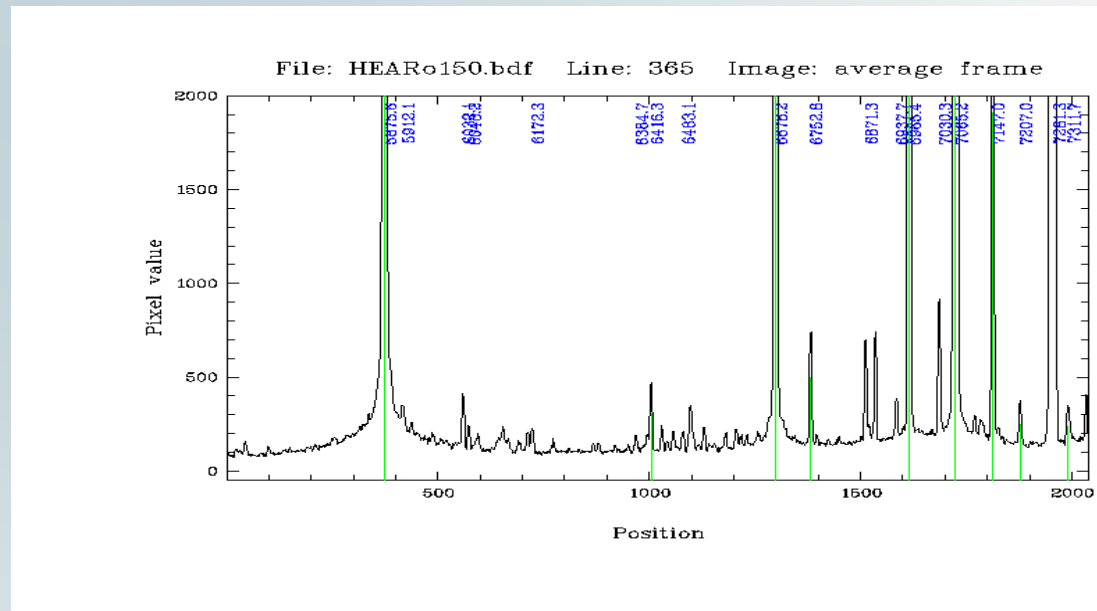

First identify some lines, then mostly automatic

Wavelength calibration (3)

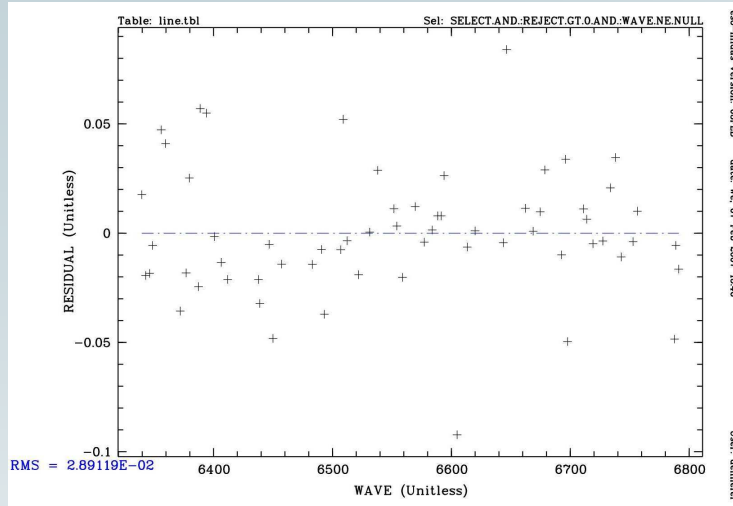

Plot residuals
Eliminate outstanding lines
Recalculate calibration

Plot delta's
If necessary, adjust degree
of polynomial (depending on instrument:
2d OK most of the time, but special cases
e.g. image tubes have S distortion, hence
3d degree preferable)

Detailed description: A large arrow points from this text towards the right.

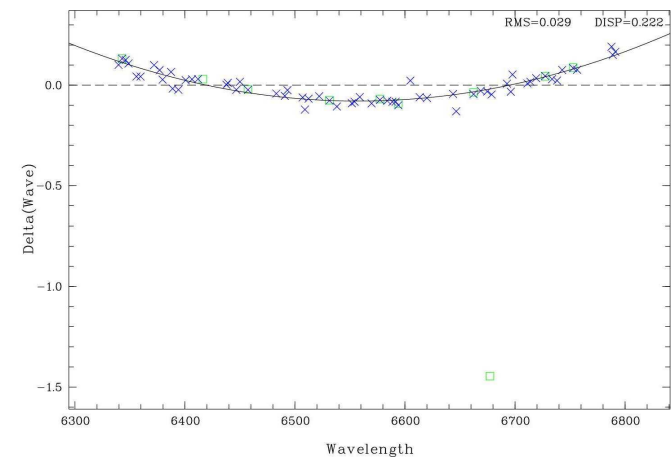

Response curve

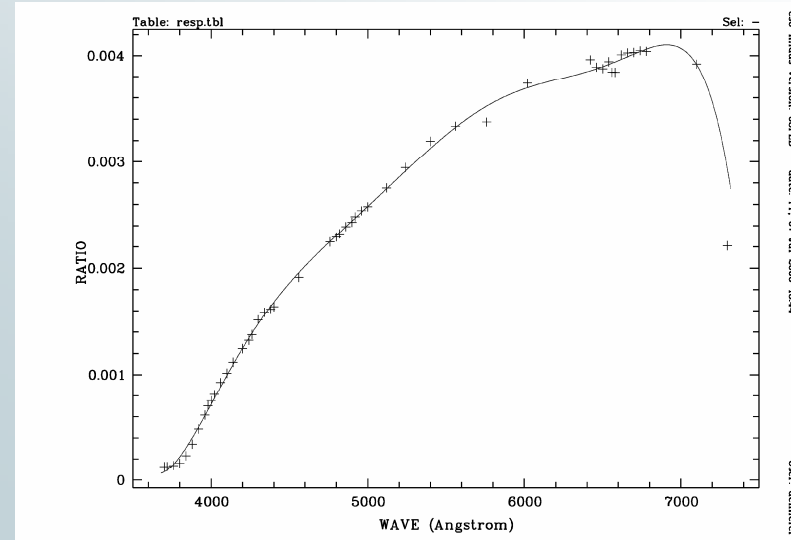
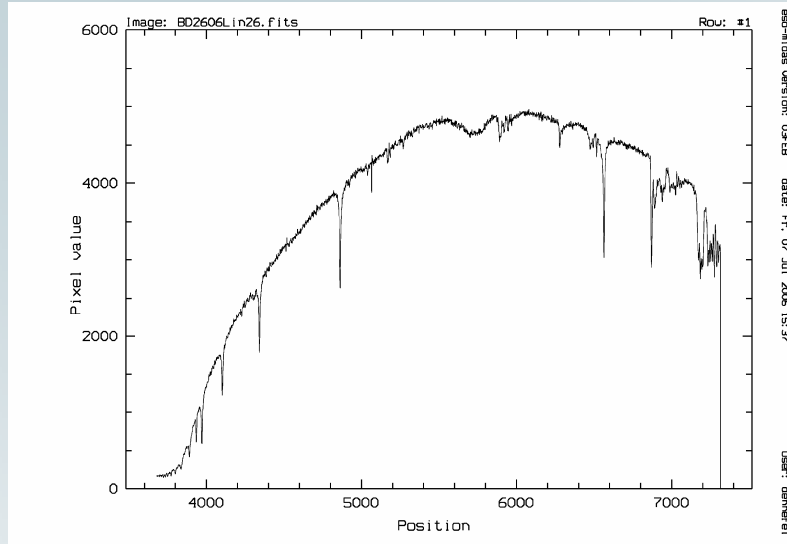

One needs to understand the origin of the shape (grating curve, detector's response, etc..) before deciding fitting method (poly, spline) and smoothing parameter.

Assumes FF has removed small scale features

Try to have more than one Std star observed (odd number if possible)...

Extraction of spectrum

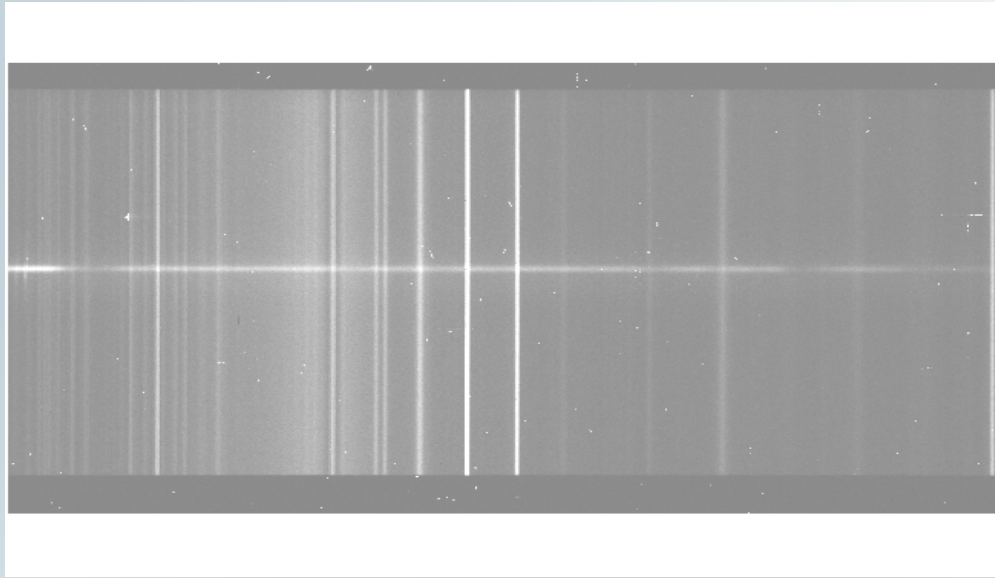

- Assumes Offset and FlatField corrected
- 2D wavelength calibration (corrects distortion)
- See if vignetting (transmission changes along the slit); can be corrected by the FF
- Cosmic rays removal
- Simple sum, or weighted sum of object lines
- Sky subtraction (average on both sides of object)

Summary of operations

$$S_* \text{ (ADU)} = G_{x,y} F_* \cdot t + O_f \quad (\text{Dark current negligible})$$

$$S_{FF} = G_{x,y} F_{FF} \cdot t' + O_f$$

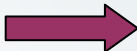
- Do $F_* / F_{FF} = (S_* - O_f) / (S_{FF} - O_f) \cdot t' / t$
and same for Standard star
- Cosmic rays correction
- Wavelength calibration
- Extraction of spectrum (with sky subtraction)
- Extinction correction
- Division by the response curve
  final spectrum in absolute units

A rough calculation of signal to noise

- $S(\text{ignal}) = E_* D^2 \Delta\lambda \eta \tau t$
E in ergs/cm²/s/Å or W/m²/Å, flux from object
D Diameter of telescope, $\Delta\lambda$ (bandpass), η (quantum efficiency), τ (transmission), t exposure time
- $N(\text{oise}) = \text{square root of total signal}$
 $= [(E_* + (2)E_s \alpha^2) D^2 \Delta\lambda \eta \tau t + n^2 L^2]^{1/2}$ (α seeing)
n number of pixels corresponding to α
- **IF** object fainter than sky, AND r.o.n. negligible, then:
 $S/N = E_* \cdot D/\alpha \cdot [\Delta\lambda \eta \tau t / E_c]^{1/2}$ or:

Limiting magnitude: $E_* = S/N \cdot \alpha/D \cdot [E_s / (\Delta\lambda \eta \tau t)]^{1/2}$
Seeing as important as diameter of telescope...!

Focal Reducer

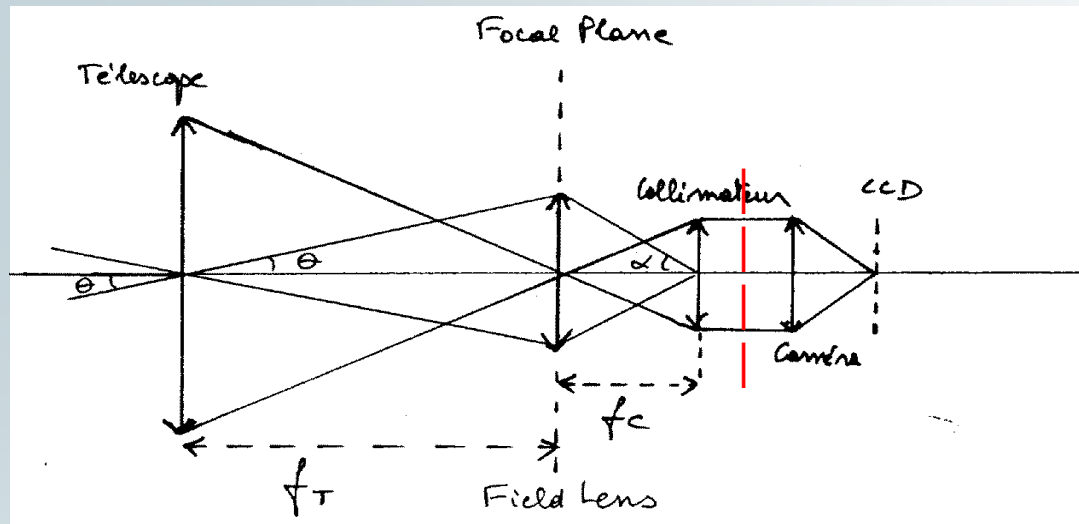

- Spectrograph is 'straightened' out, thus grating works in transmission instead of reflection

- Field of view (2θ) defined by field lens:

$$D_{FL} = 2f_T \theta = 2f_C \alpha \quad \text{Final focal length } f' = m'_{cam} D_T$$

$$\text{Reduction factor is } m_{Tel} / m'_{cam}$$

To keep exit rays 'on axis', one adds a lens or a prism to the grating: grens, or grism!

Focal reducer (2)

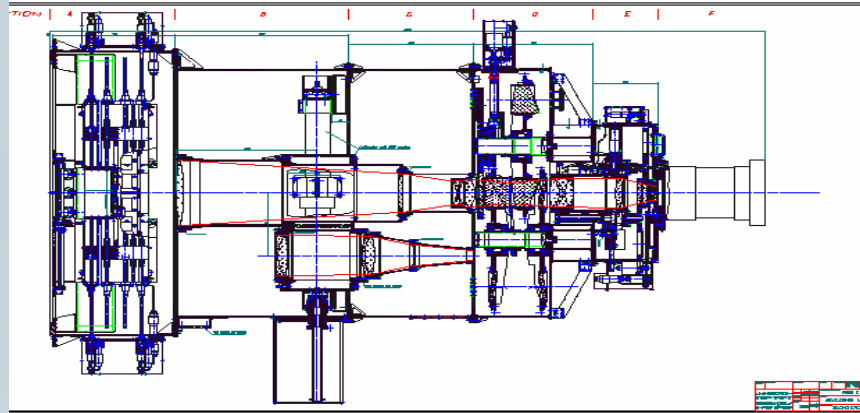

- Parallel beam: can introduce filters (in particular interference filters), gratings, Fabry-Perot's, polarimeters, etc...
- Very versatile instrument
- Entrance plate (telescope focal plane) versatile too
- Exemple of FORS/VLT (with slits or masks)

Slits, or masks?

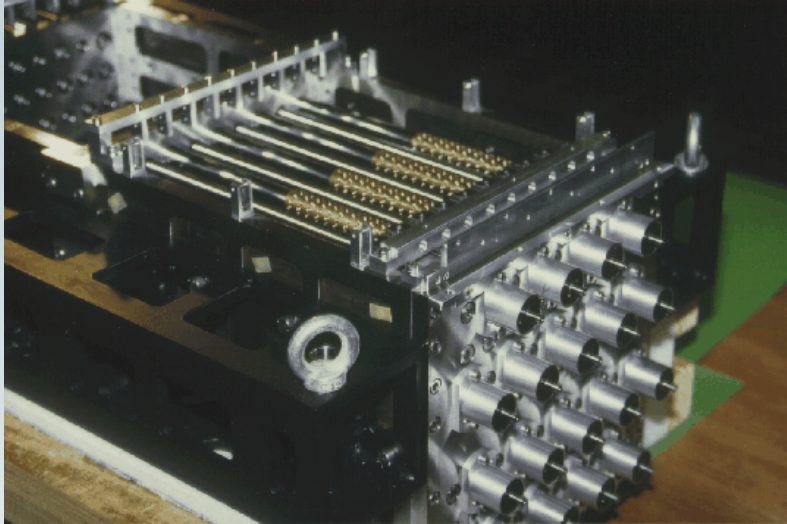

19 slits, fixed length

~30 slits, variable length

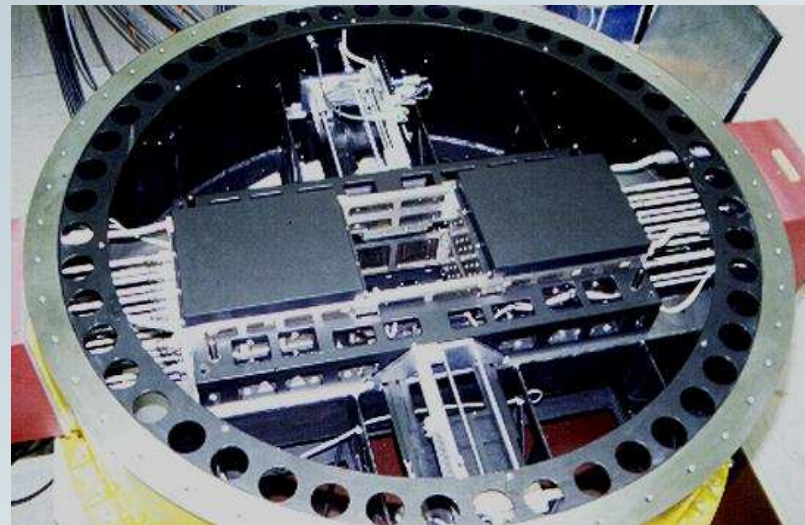

Example of multi-objects (slits)

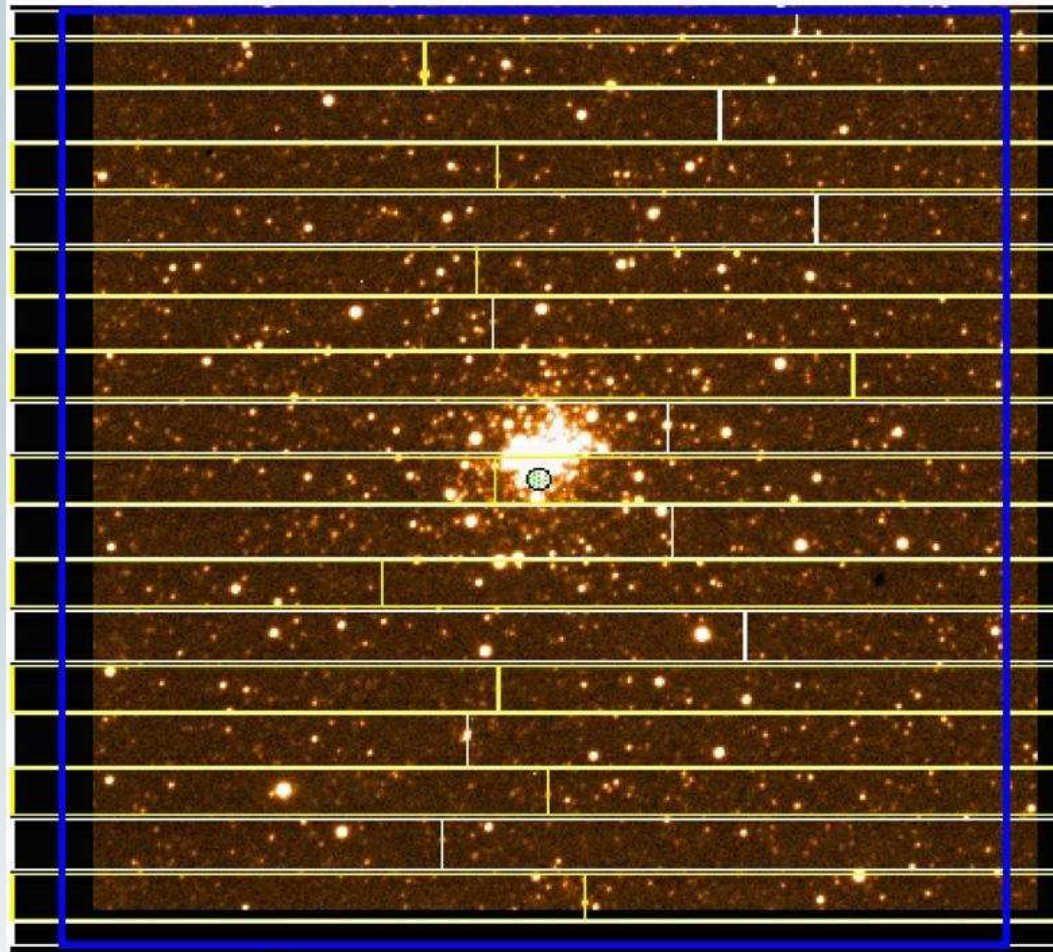

Open Cluster NGC 330 in SMC - VLT UT1 + FORS1 (MOS-mode)

Field of view: $\sim 7'$

The wavelength range depends on the position of the target in the field!

Multi-objects (masks)

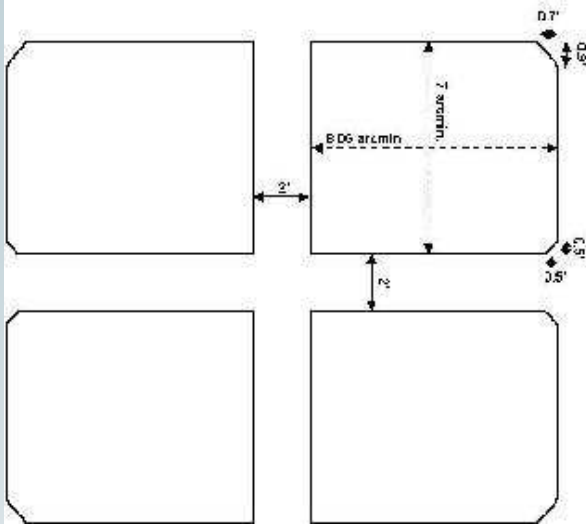

For larger fields of view:
Vimos: several quadrants, with independent optics and cameras (gaps in the field!)

Two quadrants, with about 100 slits in each mask

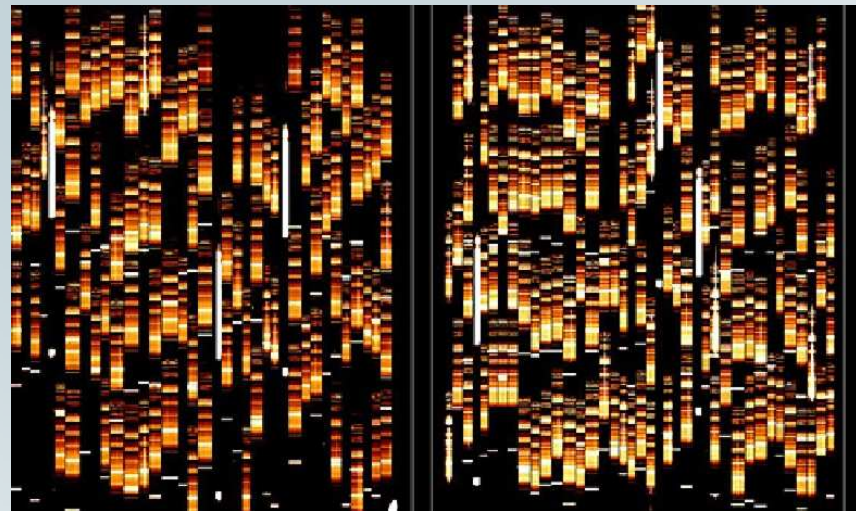

Spectroscopic modes

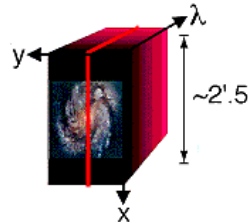
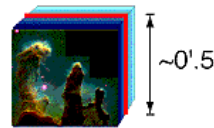
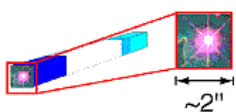
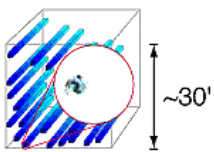
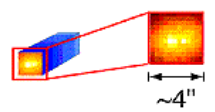
SOURCE	SPECTROGRAPHIC MODES	VLT INSTRUMENTS
L.S.S. Extended Continuum		ISAAC FORS1/2 CONICA VISIR
S.I.S. Extended Emission		CONICA
C.D.E.S. Single Point Continuum		UVES CRIRES
M.O.S. Diluted Point Continuum		FORS 1/2 NIRMOS/ VIMOS GIRAFFE
I.F.S. Single Small Continuum		GIRAFFE SINFONI

Note: also slit-less spectroscopy (objective prism or grism)

Integral field spectroscopy

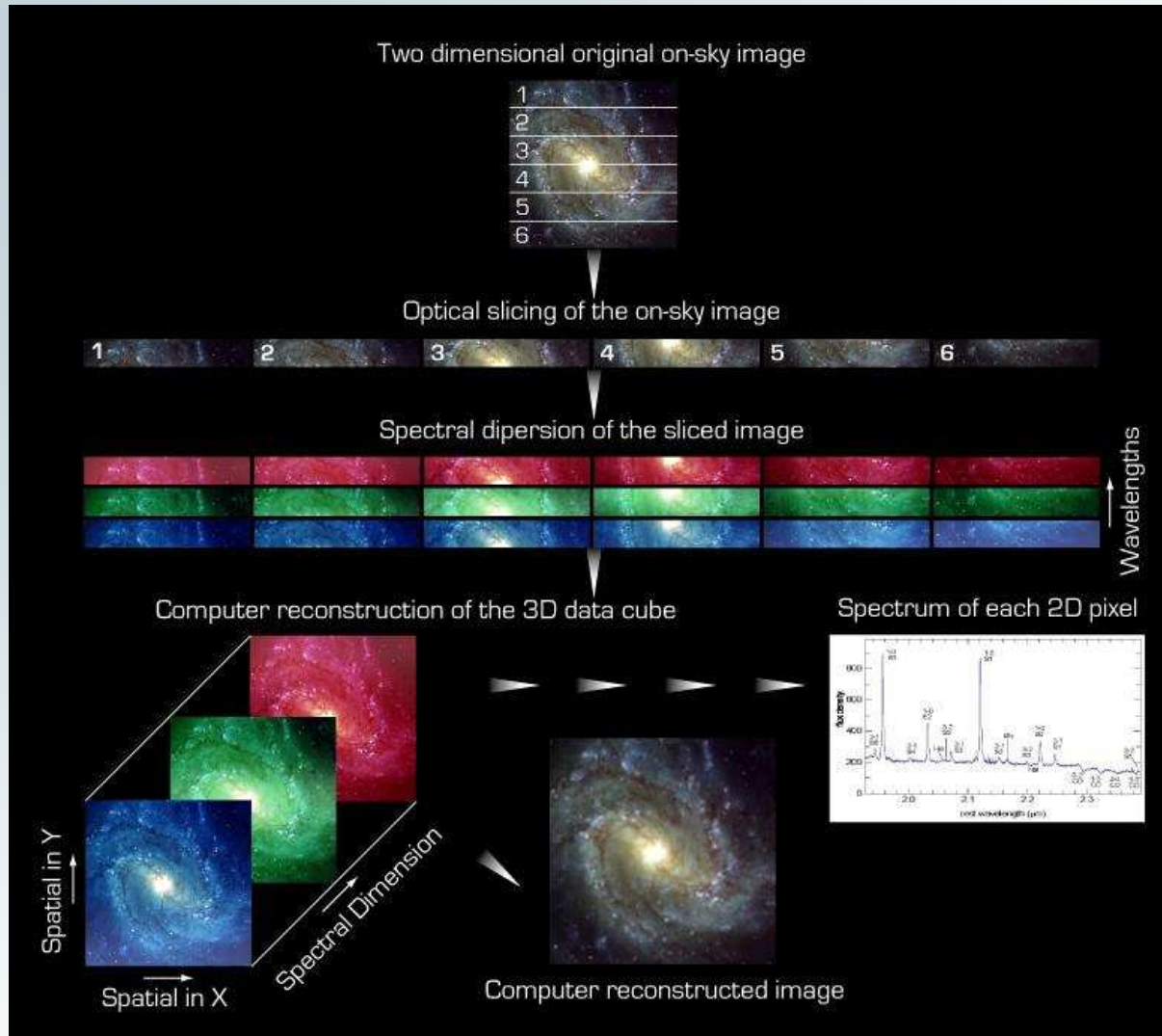

3D Spectroscopy (principle)

1. Sample object in spatial elements

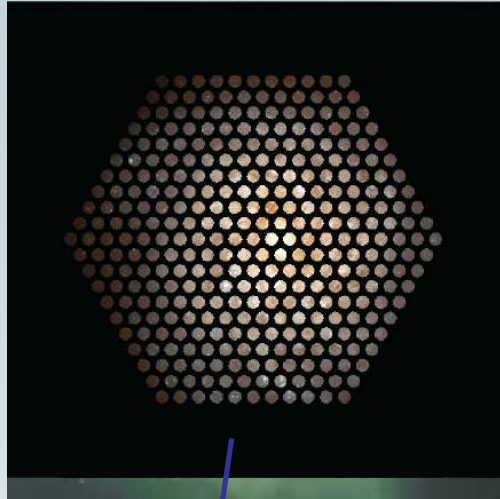

3b. Reconstruction of narrow- & broad-band images

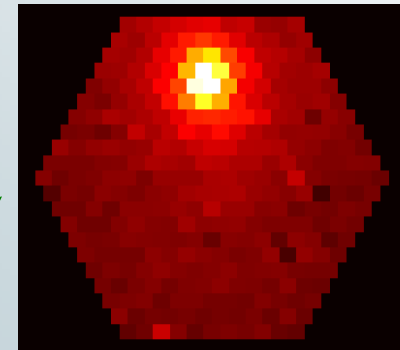

2. Re-arrange spaxels to slit and feed light to spectrograph

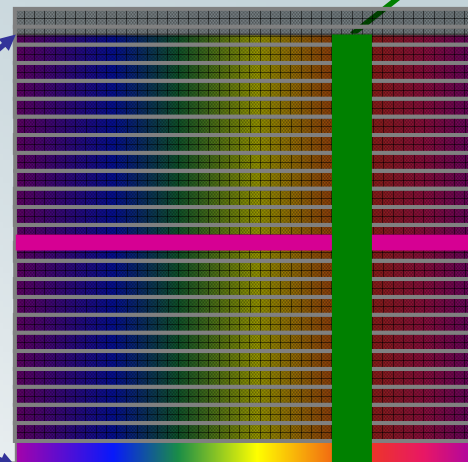
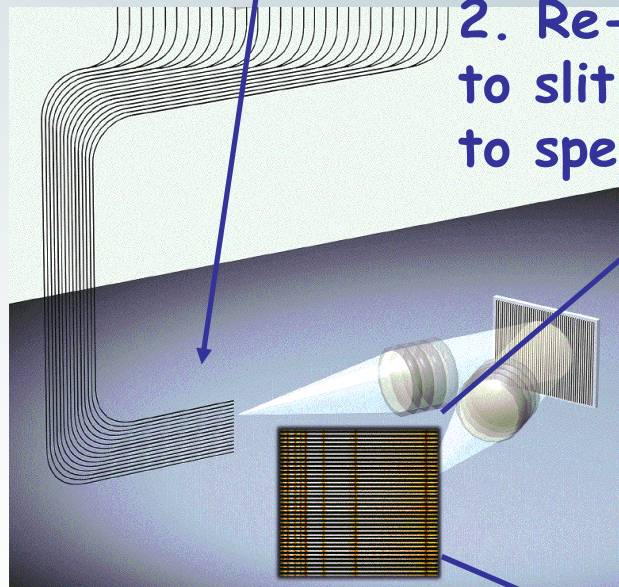

3a. Extract spectra

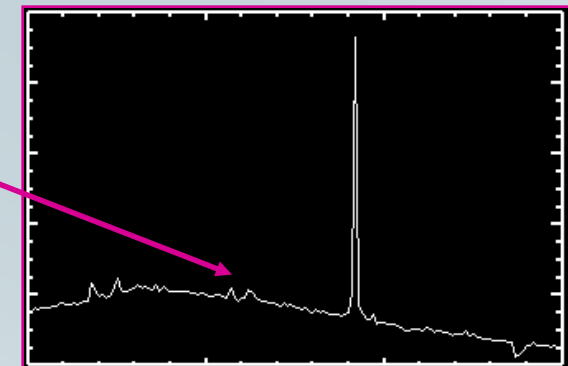

Different modes (1)

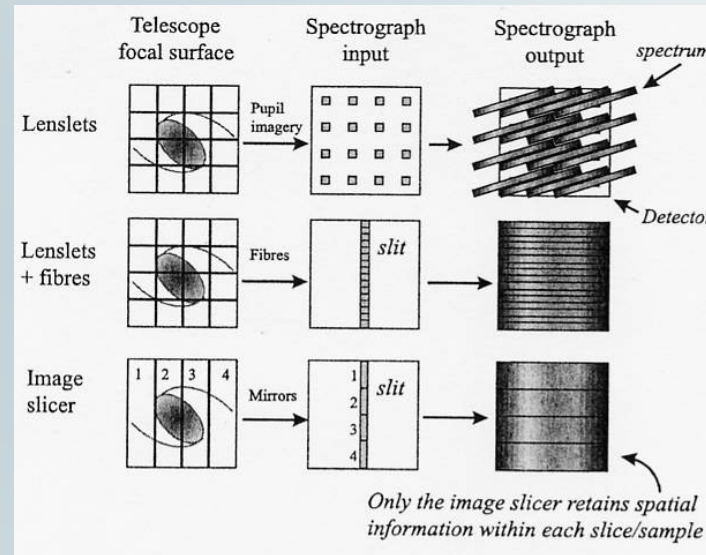

- Image slicer retains spatial information within each slice. Is used also for stellar spectroscopy with high-resolution (e.g. 1.52m at OHP)
- FOV limited because total number of pixels in detector is limited (must contain $x \cdot y \cdot z$)

Different modes (2)

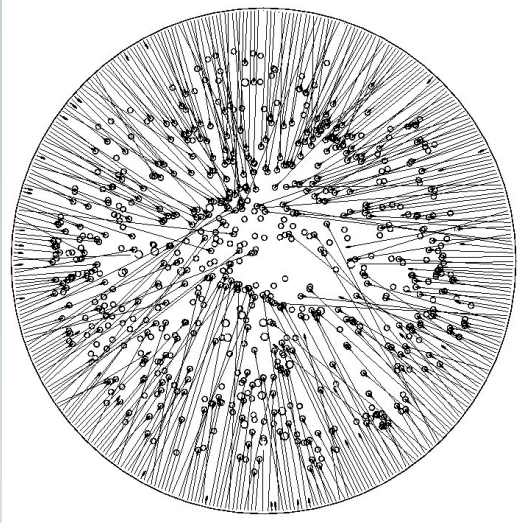

Wide field: fibers
(here 2dF)
Discontinued sampling
(Medusa mode)

Continued sampling:
IFU with lenslets
Small field of view
(a few ')
Limited by total number
of pixels in detector
($X \times Y \times \lambda$)

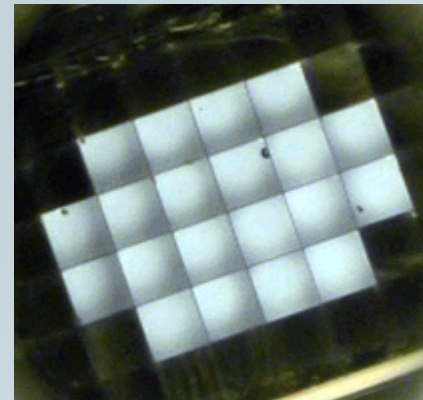

Combination: FLAMES-IF

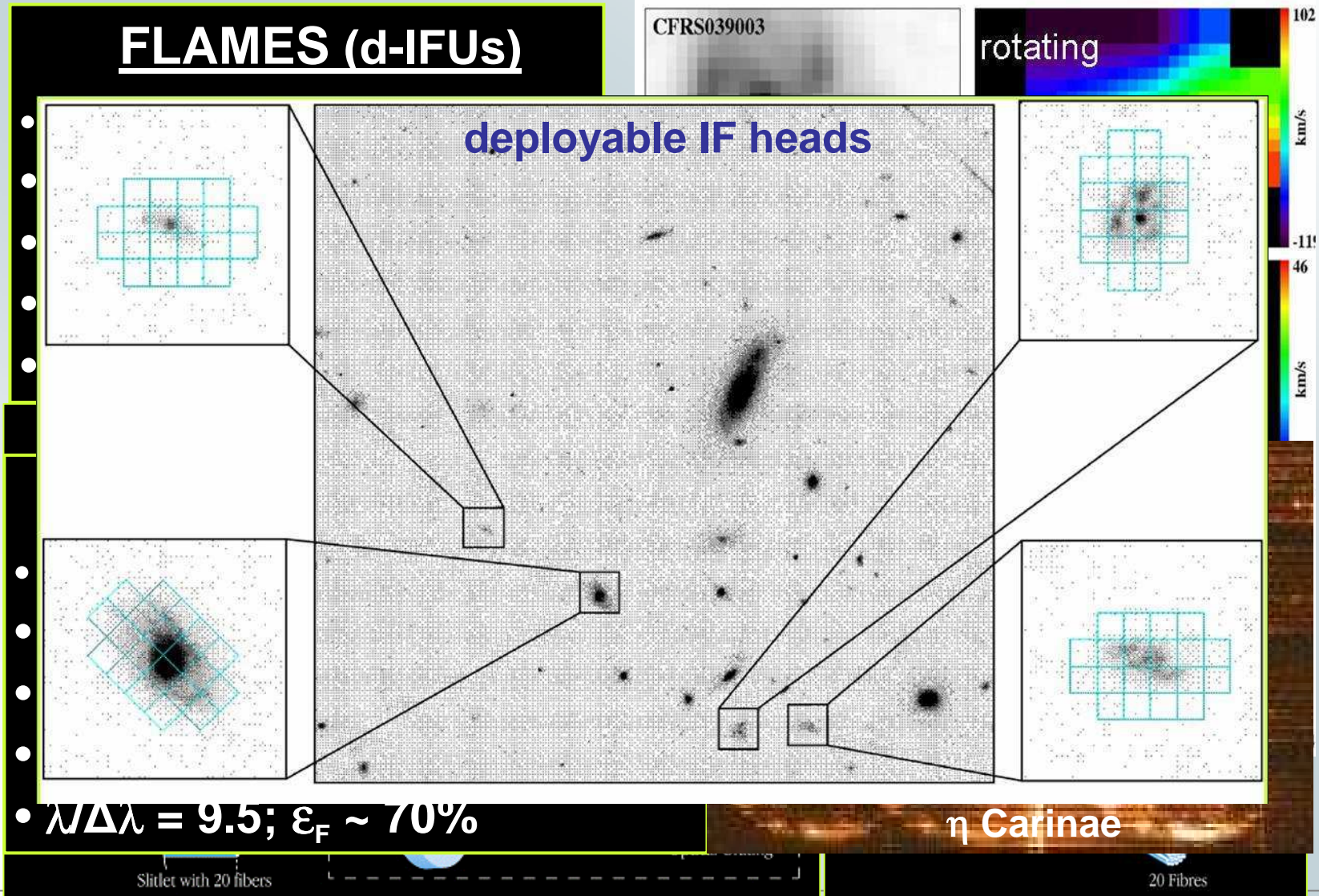

Multi-wavelength studies

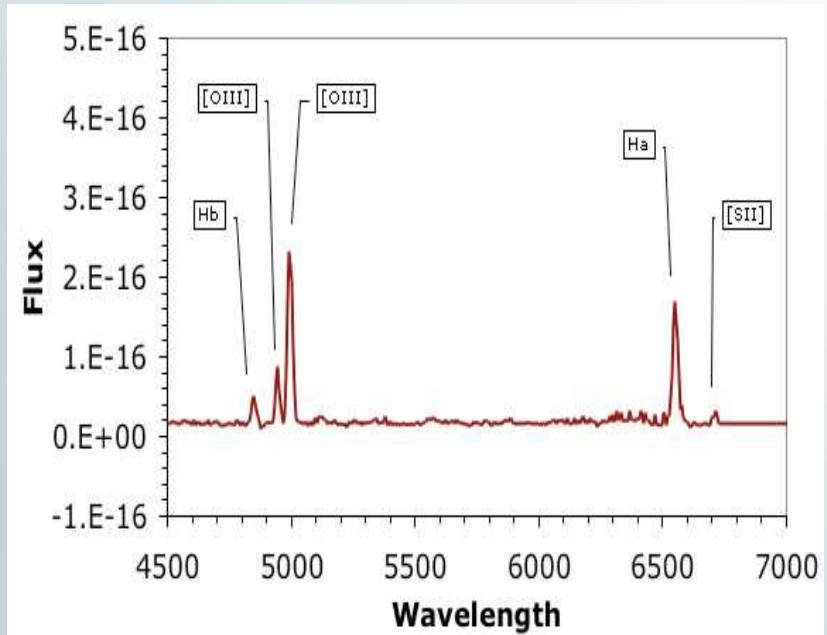
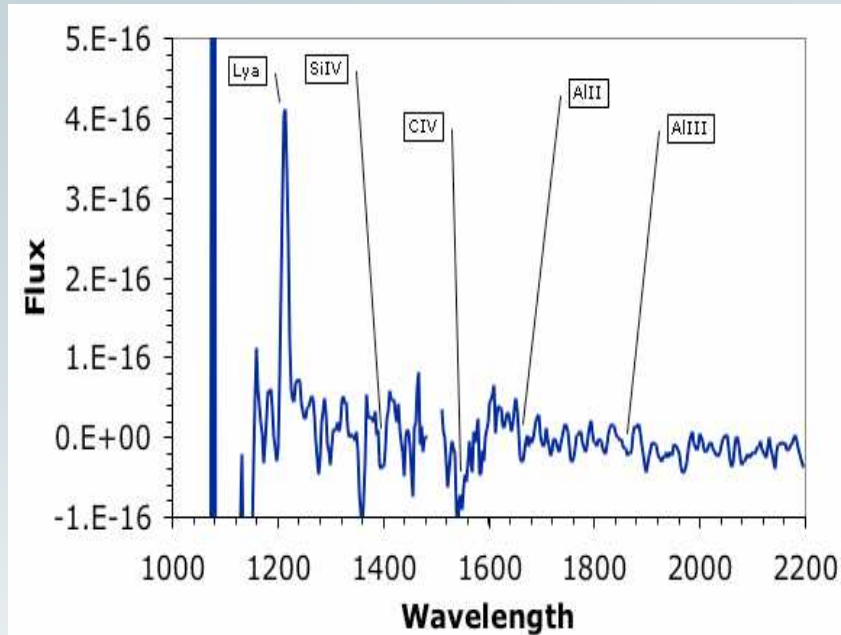

Example of Galex + Vimos: **needs flux calibration to connect!!**
Starburst in the Chandra Deep Field South observed by GALEX in
UltraViolet and by VIMOS (<http://cencosw.oamp.fr/>)
A clear Lyman α emission is detected in the spectrum of this galaxy at
a redshift $z = 0.2258$.

End of presentation

Thank you for your attention...

and have a good observing run!