



EUROPEAN SOUTHERN OBSERVATORY

Organisation Européenne pour des Recherches Astronomiques dans l'Hémisphère Austral
Europäische Organisation für astronomische Forschung in der südlichen Hemisphäre

ESO - European Southern Observatory
Karl-Schwarzschild Str. 2, D-85748 Garching bei München

Very Large Telescope Paranal Science Operations FLAMES User Manual

Doc. No. VLT-MAN-ESO-13700-2994

Issue 106.2, Date 08/07/2020

Prepared B. Haeussler
Date Signature

Approved A. Kaufer
Date Signature

Released S. Mieske
Date Signature

This page was intentionally left blank

Change Record

Issue/Rev.	Date	Section/Parag. affected	Reason/Initiation/Documents/Remarks
1.0	21/03/03	all	First Release (for P71)
1.1	21/07/03	all	Updates and Corrections Results ARGUS commissioning
1.12	24/10/03	some	Release for P72 HR update, IFU geometry, calibration times added
1.13	15/01/04	some	Minor changes for P73
1.14	01/03/04	Table 3.1	New HR settings added
1.15	04/03/04	Table 3.1	New HR setting added
1.16	18/06/04	Sects. 1.4, 1.5, 2.2, 3.1, 3.3.1, Sects. 4.4, 5.1.1, 6.2, 7.3 Figs 2.6, Tables 3.1, 7.1, 7.3	Update for P74
1.17	07/07/04	Sect. 1.4	Combined cfg λ comment
2	25/11/04	Sect. 1.2, 1.3.2, 2.4.5, 1.4, 1.6 1.7, 2.8.1, 4.3, 5.1.1	Update for P75
2	11/03/05	some	Figures quality improved
79	01/09/06	none	Version for Period 79 Phase I and II
79.1	25/12/06	Sect. 29 added	Version for Period 79 Phase II
80	27/02/07	none	Version for Period 80 Phase I and II
81	27/02/07	none	Version for Period 81 Phase I and II
82	08/03/08	none	Version for Period 82 Phase I and II
82.1	05/06/08	Sect. 3.5.4 (updated) Figure 10 (new) Table 8 (updated) Table 14 (updated) Hypertext links updated	Version for Period 82 Phase I and II
82.2	25/06/08	Fig 11 (new)	
83	08/09/08	none	Version for Period 83 Phase I and II
83.1	23/11/08	Minor typo changes	
84.0	25/02/09	All	Version for Period 84 Phase I Visitor Mode only for HR1-3 and LR1 in Argus. Figs. added to show why sky-subtraction can be important. Comment about UVES SimCal. Refs added for RV accuracy/Sky subtraction
84.1	18/06/09	All	Figs changed/added for FACBs, reconstructed IFU/Argus images and IFU throughput. Other minor typo changes.
85.0	28/08/09	All	MIT UVES CCD upgrade, Calibration plan amended, Guide star magnitudes changed.
85.1	18/12/09	Sect 4.3.2, table 13; table 11	Minor modifications
86.0	12/02/10	Sects. 2.2, 2.4, 3.3, 3.5.4 4.8.2, 5.1, 6.4, tab8	Fast readout mode for GIRAFFE
87.0	23/08/10	All Sec 2.8 Sec 4.4	Hyperlinks fixed Added to clean author list Hyperlink added to the distortion tool
88	01/03/2011	none	Version for Period 88 Phase I and II
89	30/08/2011	none	Version for Period 89 Phase I and II
90	24/02/2012	none	Version for Period 90 Phase I and II
91	01/09/2012	none	Version for Period 91 Phase I and II
91	20/11/2012	Subsection 5.7.1 added	Version for P91 phase 2
92	06/03/2013	Subsection 2.1 changed	Information on the broken UVES fibre

Issue/Rev.	Date	Section/Parag. affected	Reason/Initiation/Documents/Remarks
95	27/11/2014	Table 2	RV references updated
95	27/11/2014	All	Typos. Broken URLs fixed
97	17/12/2015	Tables 11 and 12	Resolving powers updated
98	24/09/2016	Sects. 2.2, 3.5.4, 5.1 and 6.4; Table 8	Added slow readout mode
101	24/09/2017		No changes
101.1	26/12/2017	Sects. 1.1, 2.9, 3.5.6, 4.5, 6.2 Sect 2.5 Sects 4.1 and 4.8 Sect 5.1	Updated URLs and fixed broken hyperlinks Removed references to VIMOS Updated to reflect the new web based p2 Updated to clarify the calibration plan of the slow readout mode
102.1	26/02/2018		No changes
103	30/08/2018	Sects 4.1 and 4.8	Removed references to p2pp
106	12/05/2018		Added information for FC maker, corrected Table 1 for di
106	6/07/2020	Throughout	Several updates to links and more recent information. BH
106	21/07/2020	Throughout	Guide Star magnitude limit changed to R~12 for ARGUS

This page was intentionally left (almost) blank

Contents

1	Introduction	1
1.1	On the Contents of the FLAMES User Manual	1
1.2	Information available outside this Manual	2
2	Capabilities of the Facility	3
2.1	UVES – FIBRE mode	3
2.2	GIRAFFE	5
2.3	FLAMES Observing Modes	7
2.4	Limitations and Caveats	7
2.5	FLAMES within the VLT Observatory	10
2.6	High-resolution spectrographs at ESO La Silla	11
2.7	FLAMES Sample Observations and Calibrations	11
2.8	Acknowledgment	12
2.9	Bibliography and Further Documentation	12
2.10	Glossary	13
2.11	Abbreviations and Acronyms	15
3	FLAMES Characteristics and Sub-Systems	16
3.1	Opto-mechanical Layout	16
3.2	Corrector	17
3.3	Fibre Positioner (OzPoz)	18
3.3.1	Positioner Performance Characteristics	20
3.4	Buttons and Fibre Systems	20
3.4.1	Magnetic Buttons	21
3.4.2	UVES Fibres	22
3.4.3	MEDUSA Fibres	23
3.4.4	IFU Fibres	25
3.4.5	IFU Orientation	26
3.4.6	ARGUS Fibres	26
3.5	GIRAFFE	26
3.5.1	Slit Unit	28
3.5.2	Filters and the Filter Wheel	28
3.5.3	Dioptric Spectrograph	28
3.5.4	GIRAFFE scientific CCD “Carreras”	30
3.5.5	Spectral Format and Efficiency	32
3.5.6	GIRAFFE Setup Stability and Repeatability	33
3.5.7	GIRAFFE Calibration Units	33
3.6	UVES – FIBRE mode	34
3.6.1	The RED Spectrograph Arm	35
3.6.2	Scientific CCD Mosaic “STING”+“ZEUS”	36

3.6.3	Spectral Resolution and Overall Efficiency	37
3.7	FLAMES Features and Problems	38
3.7.1	Maximum reachable S/N ratio	39
3.7.2	Enhanced Dark Current after a FIERA Start-up	39
3.8	GIRAFFE Features and Problems	39
3.8.1	Low counts in blue attached screen flatfields	39
3.8.2	Contamination from Simultaneous Th-Ar Calibrations	39
3.8.3	In-focus Ghosts and Scattered Light	40
3.8.4	CCD Defects	40
3.9	UVES Features and Problems	40
3.9.1	UVES SimCal lamp too bright for long exposures	40
3.9.2	Fibre Overlap in the 520 nm Setup	41
3.9.3	Fibre-to-fibre Contamination	41
3.9.4	Spectral Gaps in the RED	42
3.9.5	Optical Ghosts in the far red Spectra	42
3.9.6	CCD Cosmetic Defects	42
4	Preparing the Observations	44
4.1	Introduction	44
4.2	FLAMES Modes and basic Choices	45
4.3	GIRAFFE and UVES Standard Settings	46
4.3.1	GIRAFFE Standard Settings	47
4.3.2	UVES Standard Settings	49
4.4	Differential Atmospheric Effects	50
4.5	Preparing the Target Input Files	54
4.5.1	Run FPOSS to Prepare the Target Setup Files	55
4.6	Broken and low-transmission fibres	56
4.7	Introducing the Observation Blocks	56
4.7.1	GIRAFFE and UVES Exposure Time Calculators	58
4.7.2	Choice of the Sample Target	58
4.7.3	Choice of Instrument Configuration and Spectral Format	59
4.7.4	Exposure Time and predicted Counts and S/N Ratios	59
4.8	The p2 tool	59
4.8.1	Acquisition Templates	59
4.8.2	Observing Templates	60
4.8.3	Computing Time Overheads for your Programme	60
5	The Calibration of FLAMES Data	62
5.1	General Concept	62
5.2	Positioner Calibration Unit	62
5.3	Nasmyth Screen	63

5.4	Simultaneous Calibrations	63
5.5	Longslit Calibrations	63
5.5.1	GIRAFFE Longslit Unit	63
5.6	The UVES Calibration Unit	64
5.7	Fibre to Fibre Transmission and Sky Subtraction issues	64
5.7.1	New strategies for sky subtraction	65
5.8	Special Calibrations	65
5.8.1	Detector Flats	65
5.8.2	Use of Telluric Standard Stars to correct for Fringing or atmospheric Lines	65
5.9	FLAMES Science Calibration Plan	68
6	FLAMES Observing Operations	70
6.1	During the Night	70
6.2	Pointing and Guiding	71
6.3	ARGUS fast observations	72
6.4	Evaluation of the Results, Offline Data Analysis	72
6.5	FLAMES Raw Data Structure	73
6.5.1	HDU2: OzPoz_table	73
6.5.2	HDU3: FLAMES FIBRE Table	74
7	Appendix	77
7.1	FLAMES Raw Data Spectral Format	77
7.1.1	GIRAFFE - MEDUSA	78
7.1.2	GIRAFFE - IFU	79
7.1.3	GIRAFFE - ARGUS	81
7.1.4	UVES - FIBRE	82
7.2	Characteristics of GIRAFFE Filters	83
7.3	FLAMES calibration times	88
7.4	Comparison between old and new HR gratings	88

List of Figures

1	Schematic view of an Integral Field Unit	6
2	MEDUSA entrance losses due to fibre-object decentering	9
3	View of the Fibre Positioner and GIRAFFE on the Nasmyth A Platform	16
4	TCCD image of the Fiducial Stars	19
5	Histogram of Fibre Transmission at 600 nm	21
6	UVES Fibre Bundles and Slit Geometry	22
7	Schematic view of Microlenses	24
8	MEDUSA Fibre Bundles and Slit Geometry	25
9	ARGUS Microlens Array and Slit Geometry	27

10	Quantum Efficiency ratio New chip/Old chip	29
11	Fringing: Old and New chip comparison	30
12	GIRAFFE Spectral Format and Slit Curvature	33
13	QE Zeus / Nigel	37
14	Finging for Zeus and Nigel	38
15	UVES Fibre-to-Fibre Contamination	41
16	Atmospheric Dispersion Effects at 9 arcmin from center	51
17	Atmospheric Dispersion Effects at 12.5 arcmin from center	52
18	Chromatic Atmospheric Dispersion Effects	53
19	FPOSS Sample Input File	55
20	Raw GIRAFFE IFU images of the solar spectrum on plate 1 (top) and plate 2 (bottom) taken in May 2009. Variations in the IFU responses on each plate are clear although the absolute level depends on the solar illumination so this figure should not be used to compare the two plates.	57
21	Image taken at L881.7-nm showing many sky lines	66
22	Extracted spectra at L881.7	67
23	Argus reconstructed image with Argus position angle in the acquisition set to +45 degrees. Top panel: Original pointing. Bottom panel: Telescope moved by 1.0 arcseconds North and 1.0 arcseconds East i.e. the object moves 1.0 arcseconds South and 1.0 arcseconds West on ARGUS.	76
24	GIRAFFE - MEDUSA Spectral Format	78
25	GIRAFFE - IFU Spectral Format	79
26	Reconstructed image of 15 IFU units produced by the pipeline.	80
27	GIRAFFE - ARGUS Spectral Format	81
28	UVES - FIBRE Spectral Format	82
29	GIRAFFE Filters HR 01-06	83
30	GIRAFFE Filters HR 07-12	84
31	GIRAFFE Filters HR 13-18	85
32	GIRAFFE Filters HR 19-22, LR 01-02	86
33	GIRAFFE Filters LR 03-08	87

1 Introduction

1.1 On the Contents of the FLAMES User Manual

The current version of the FLAMES user manual is available online as a retrievable pdf file at the FLAMES ESO home page:

<http://www.eso.org/sci/facilities/paranal/instruments/flames/doc/>

Prior to the observing proposal application and/or phase 2 announcements, the User Manual is usually updated; any significant changes are announced on the FLAMES web pages. If you do not have access to the WWW, a printed copy can be requested from ESO's Visiting Astronomers Section (e-mail: visas@eso.org) in Garching, Germany. Paper copies of a new version of the FLAMES User Manual are printed out only after a major revision of the document.

Chapter 2 is addressed to users who are not familiar with the FLAMES facility and who are interested in a **quick overview** of its capabilities, as in the case of similar VLT (and La Silla) instruments. This should enable a potential user to select the best instrument for a given observing program. It also includes information on how to access FITS files of reference FLAMES spectra and a glossary of terms used in the Manual.

Chapter 3 provides the **description of the instrument**: the instrument layout (§ 3.1), its main components (Corrector, § 3.2; Fibre Positioner, § 3.3, Fibre System, § 3.4), the properties of GIRAFFE and UVES (§ 3.5, 3.6) spectrographs, including their resolving power and overall efficiency. In addition, it contains the *requirements* to be kept in mind while planning the observations or reducing the data. It can be consulted by users who want to prepare an Observing Proposal (Phase I), but should definitely be read by those who have been granted observing time and have to prepare their observations (Phase II). **In particular, the description of the Atmospheric Effects affecting FLAMES observations and their consequences on planning and optimizing the observations is of fundamental importance. In particular, for MEDUSA mode the relative astrometry should be better than 0.3 arcseconds for all targets.**

Chapter 4 presents the basic information needed to **prepare an observing programme**: the various observing modes (§ 4.2), the standard wavelength settings (§ 4.3), and a description of the Exposure Time Calculator (§ 4.7.1). **This chapter explains how to prepare a target input file and how to generate a positioner allocation file.** It assumes that the reader is familiar with the fibre assignment software (FPOSS) and with the FLAMES templates. The FPOSS manual and template descriptions are provided as separate documents and released before Phase II.

Chapter 5 deals with the **calibration** strategy (wavelength, flat-fielding, relative and absolute calibrations) of the data obtained in standard operation. It also outlines the calibration techniques for high velocity accuracy and demanding sky subtraction. Chapter 6 provides information for the visiting astronomers who come to the Paranal Observatory to use FLAMES. A description of the raw data format is presented in § 6.5.

The **detailed technical information** on the instrument (e.g., transmission curves of the GIRAFFE filters) can be found in the Appendices (Chapter 7).

The **FLAMES Templates Reference Guide** [1] contains detailed instructions for the use

of the observing and calibration templates. The **FPOSS manual** [2] illustrates the use of the positioner software for the allocations of the fibres to the objects are given as separate documents, although they should be considered by the user as PART of the present manual.

1.2 Information available outside this Manual

If you cannot find a specific piece of information in the FLAMES User Manual or in case you have remaining questions, please check <http://www.eso.org/sci/observing/> or more specifically:

- For information on the instrument performance, Phase I, and Phase II proposal preparation, please contact the User Support Division (usd-help@eso.org).
- For Phase II preparation of Service Mode Observation Blocks (OBs) follow the instructions given on the p2 website:

<https://www.eso.org/sci/observing/phase2/p2intro.FLAMES.html>

- For questions directly related to your granted observing run in Visitor Mode, please contact Paranal Science Operations (ps@eso.org and flames@eso.org). Visitor mode specific information on FLAMES is found at:

<http://www.eso.org/sci/facilities/paranal/instruments/flames/visitor.html>

- For updates on the instrument not yet recorded in the current version of the user manual, consult the FLAMES web page at:

<http://www.eso.org/sci/facilities/paranal/instruments/flames/>

- For technical information on the instrument *not* related to an observing programme, please contact USD (usd-help@eso.org).

2 Capabilities of the Facility

FLAMES is the multi-object, intermediate and high resolution fibre facility of the VLT. Mounted at the Nasmyth A platform of UT2 it offers a rather large corrected field of view (25 arcmin diameter).

FLAMES consists of several components:

- An optical **Corrector**, providing excellent image quality and tele-centricity over the full field of view of 25 arcmin diameter.
- A **Fibre Positioner** hosting two plates. While one plate is observing, the other one is positioning the fibres for the subsequent observations, therefore limiting the dead time between observations to less than 15 minutes.
- A link to the **UVES** spectrograph (RED arm) via eight single object fibres per plate.
- A high and intermediate resolution optical spectrograph, **GIRAFFE**, with its own fibre systems in three possible configurations: MEDUSA, IFU, ARGUS.
- A coordinating observing software system, that allows **simultaneous UVES** and **GIRAFFE** observations.

The operation of FLAMES requires that the observer has her/his own target coordinate list, with a relative astrometric accuracy better than ~ 0.3 arcsec (rms) at the time of the Phase 2 proposal preparation.

The minimum object separation is 11 arcsec, which is limited entirely by the size of the magnetic buttons. The Fibre Positioner is able to position the fibres with an accuracy better than ± 0.1 arcsec (peak-to-peak).

In addition to the targets, the user must also provide coordinates for one VLT guide star and four fiducial stars in the **same** astrometric solution as the targets. The VLT guide star is used to first point the telescope and to close the active optics loop, while the four fiducials are used to correct this pointing for further small offsets in coordinates due to corrections of the field geometry. Ideally it should have an R -magnitude of between ~ 9 – 11 . For ARGUS observations, where the guide star can be selected closer to the center of the field of view, a fainter magnitude limit of $R \sim 12$ is applied.

2.1 UVES – FIBRE mode

UVES is the high resolution spectrograph of the VLT UT2. It has been designed for working in slit mode only but was modified to add a fibre mode on its **RED** arm. Each positioner plate has eight fibres connected to the red arm of UVES. In 520-nm mode only 6 of these are available. With an aperture on the sky of 1 arcsec, the fibres project onto five UVES pixels in the dispersion direction giving a resolving power of ~ 47000 .

In addition to the eight fibres per plate, an extra fibre fed by a separate calibration unit is available. This fibre is used for simultaneous wavelength calibration in order to obtain very accurate radial velocities. Only seven fibres can be devoted to astronomical objects when this

Spectro.	Mode	N. Objects	Aperture ["]	R	Cover.
UVES	RED	8 (with sky)	1.0	47000	200
UVES7	RED	7 (with sky) +1 Simul. Calib.	1.0	47000	200
GIRAF HR	MEDUSA	131 ^a (with sky)	1.2	19000 [†]	$\lambda/22 - \lambda/12$
GIRAF LR	MEDUSA	131 ^a (with sky)	1.2	7000 [†]	$\lambda/9.5$
GIRAF HR	IFU	15 (+15 sky)	2×3	30000 [†]	$\lambda/22 - \lambda/12$
GIRAF LR	IFU	15 (+15 sky)	2×3	11000 [†]	$\lambda/9.5$
GIRAF HR	ARGUS	1	11.5×7.3 or 6.6×4.2	30000 [†]	$\lambda/22 - \lambda/12$
GIRAF LR	ARGUS	1	11.5×7.3 or 6.6×4.2	11000 [†]	$\lambda/9.5$
Spectro.	Mode	V S/N=10	V S/N=30	"/pix	RV accuracy [‡]
UVES	RED	17.5	15.5	0.18	300 m s ⁻¹
UVES7	RED	17.5	15.5	0.18	30 m s ⁻¹
GIRAF HR	MEDUSA	19.3	17.4	0.19	150 m s ⁻¹
GIRAF LR	MEDUSA	19.9	18.0	0.19	300 m s ⁻¹
GIRAF HR	IFU	17.8 [‡]	15.7 [‡]	0.19	150 m s ⁻¹
GIRAF LR	IFU	18.5 [‡]	16.5 [‡]	0.19	300 m s ⁻¹
GIRAF HR	ARGUS	17.8 [‡]	15.8 [‡]	0.15	150 m s ⁻¹
GIRAF LR	ARGUS	18.5 [‡]	16.5 [‡]	0.15	300 m s ⁻¹

(†): The resolving powers (R) given here are only average values, for details see Tables 11 and 12, which contain a description of all the GIRAFFE setups.

(‡) Magnitudes for IFU and ARGUS modes are given for extended objects, in surface brightness (magnitudes/arcsecond)/For these numbers, the settings used are: mag/arcsec in Vega system, Moon FLI 0.1, Airmass 1.2, IQ 0.8 arcsec, in setups HR10 or LR4, respectively.

(‡) Radial velocity accuracy is estimated for a slowly rotating solar-like star over several days. See Sect. 5.4. We also refer the reader to values of radial velocity accuracy claimed by a number of authors and shown in Table 2 that should be consulted for more information.

(a) The number of allocatable buttons is 132, but only 131 spectra are fully covered on the detector.

Table 1: FLAMES characteristics and observing capabilities. The wavelength coverage (Cover.) is given in nanometers. The S/N ratio is given per wavelength pixel (as in the ETC) and it refers to the mean S/N ratio in the setups LR4 (543.1 nm) and HR10 (548.8 nm), using as inputs a G2 star for point-like and elliptical galaxy for extended sources. Additional assumptions include 1 hour exposure, dark time, 0.8 arcsecond seeing, airmass 1.2 and a fibre perfectly centered on the object.

Table 2: References for **claimed** radial velocity accuracy derived with FLAMES. The resultant velocity error is affected by factors such as the grating setup used, whether or not SimCal was activated, the time period over which the observations were taken and reduction techniques, amongst others. The references contain much more specific information than it is possible to show in the table and should be consulted for more details.

Reference	Mode	Science	Magnitudes	RV err
Battaglia et al., MNRAS, 383, 183 (2008)	FL-GIR	Sculptor	V \sim 18	1.6 km s ⁻¹
Bouchy et al., A&A, 431, 1105 (2005)	FL-UVE	OGLE survey	V = 15.7	51 m s ⁻¹
Koch et al., AJ, 134, 566 (2007)	FL-GIR	LeoI dSph	V \sim 18–21	2.4 km s ⁻¹
Loillet et al. A&A, 479, 865 (2008)	FL-GIR	CoRoT fields	V \sim 11–16	30 m s ⁻¹
Maxted et al., MNRAS, 385, 2210 (2008)	FL-GIR	LM binaries	I \sim 14–19	0.6 km s ⁻¹
Pancino et al., ApJ, 661, L155 (2007)	FL-GIR	w-Cen	B \sim 13–15	0.2–0.8 km s ⁻¹
Sommariva et al., A&A, 493, 947 (2009)	FL-GIR	M4	V \sim 12–18	< 0.3 km s ⁻¹
Tolstoy et al., ApJ, 617, 119 (2004)	FL-GIR	Sculptor dSph	V \sim 19.5	2.0 km s ⁻¹
Udalski et al., A&A, 482, 299 (2008)	FL-UVE	OGLE survey	I = 14.3	46 m s ⁻¹
Sacco et al., A&A, 565, 113 (2014)	FL-GIR	GAIA survey	V \sim 12–16	0.4 km s ⁻¹

simultaneous calibration fibre is used. Note that this simultaneous calibration fibre mode is only available in the 580 nm setup. For faint objects one or more fibres can be devoted to the sky.

When used in Fibre mode, only the three standard UVES RED setups are offered, with central wavelength of 520, 580 and 860 nm, respectively (see the UVES user manual for details):

<http://www.eso.org/sci/facilities/paranal/instruments/uves/doc/>

The UVES fiber 37 on plate 2 is broken since September 11, 2012. This led to a UVES pipeline update (available already in version 5.0.16 and following versions), which reduces the data without issues. For an up-to-date list of broken fibres, please check Section 4.6 and . Users are invited to discuss with their USD support astronomer during phase 2 preparation to devise a strategy to cope with the missing fiber.

2.2 GIRAFFE

GIRAFFE is a medium-high resolution spectrograph ($R = 7500 - 45000$) for the entire visible range (370 – 950 nm). It is equipped with two gratings (high and low resolution) and uses order sorting filters to select the required spectral range. Each object can be only observed in one, or a fraction of a single, echelle order at once. GIRAFFE is equipped with a 2k×4k EEV CCD (15 μ m pixels), with a scale of 0.19 arcsec/pixel.

The fibre system feeding GIRAFFE consists of the following components:

- 2 **MEDUSA** fibre slits, one per positioner plate. Up to 131 different objects (including sky fibres) are accessible in MEDUSA single fibre mode, each with an aperture of 1.2 arcsec on the sky. 5 additional fibres allow simultaneous calibration of every exposure.

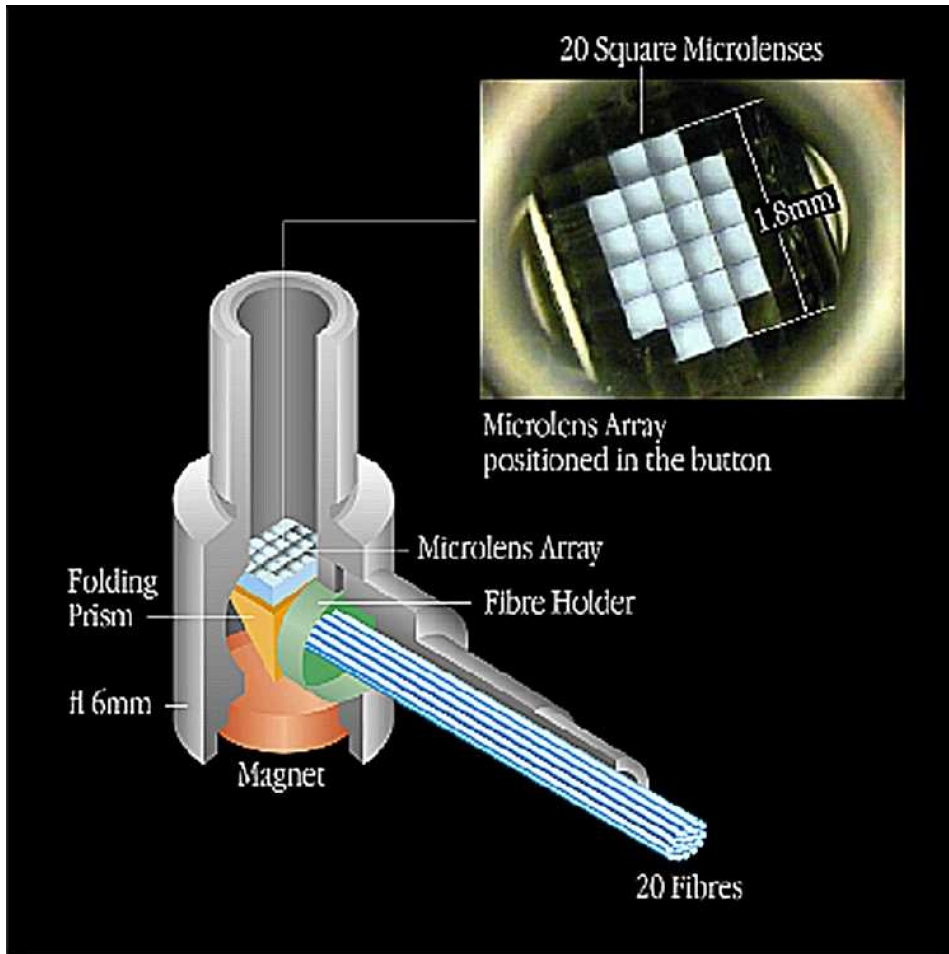

Figure 1: Schematic representation of a deployable Integral Field Unit (IFU), in its button. The signal from the rectangular microlens system (0.52 arcsecond squared per microlens) is brought to the Giraffe spectrograph through 20 fibres. The fibres of one IFU form one subslit of the IFU slit.

- **2 IFU** slits, one per positioner plate. Each deployable Integral Field Unit (IFU) consists of an array of 20 square microlenses of 0.52 arcsec side each, giving a total (almost rectangular) aperture of $\sim 3 \times 2$ arcsec. For each plate there are 15 IFUs dedicated to objects and 15 IFUs dedicated to sky measurements; the latter contain the central fibre only. A schematic representation of an IFU in its button is given in Figure 1.
- **1 ARGUS** slit. The large integral unit ARGUS consists of a rectangular array of 22 by 14 microlenses. It is fixed at the center of positioner plate 2. Two scales are available: one with a sampling of 0.52 arcsec/microlens (scale 1:1) and a total aperture of ~ 12 by 7 arcseconds, and one with a sampling of 0.3 arcsec/microlens and a total coverage of 6.6 by 4.2 arcseconds (scale 1:1.67). 15 ARGUS single sky fibres are also available. These can be positioned within the 25 arcmin field (cf. Figure 9). **The ARGUS long axis is along the N–S direction for a position angle of 0 degrees, with the PA entered in FPOSS being measured North–East. See Fig. 23.**

Users should pay attention to the small list of broken fibres (see Sec. 4.6).

GIRAFFE is operated with 39 fixed setups (31 high resolution + 8 low resolution) whose characteristics are given in Table 11 and Table 12. In addition to the normal readout mode

of 225KHz, 1x1, high gain, a fast readout mode of 625KHz, 1x1, low gain is offered in visitor mode. Furthermore, a slow readout mode of 50kHz, 1x1, high gain – providing higher S/N at the cost of longer readout times – has been offered in visitor mode only.

For performance estimates (based on measured transmission curves and performances) the user is referred to the Exposure Time Calculator at <http://www.eso.org/observing/etc/>

A summary of the GIRAFFE characteristics is given in Table 1, including estimated best performance S/N ratios.

2.3 FLAMES Observing Modes

The FLAMES observing software (OS) coordinates the various observing modes (MEDUSA, IFU, ARGUS). In addition, it allows a simultaneous acquisition of UVES and GIRAFFE observations with the specific observing modes listed in Table 3. It is important to note that during a combined observation the exposure times for UVES and GIRAFFE do not need to be the same, but the longest exposure time will determine the overall length of the observation.

Table 3: Summary of the various single and combined modes of FLAMES

Spectrograph	Mode
Single Modes:	
UVES	(a): 8 target fibres (580 nm or 860 nm setups)
UVES	(b): 7 target fibres + 1 Simul. Calib. Fibre (580 nm setup only)
UVES	(c): 6 target fibres (520 nm setup)
GIRAFFE	MEDUSA
GIRAFFE	IFU
GIRAFFE	ARGUS
Combined Modes:	
UVES + GIRAFFE	UVES (a), (b) or (c) + MEDUSA
UVES + GIRAFFE	UVES (a), (b) or (c) + IFU
UVES + GIRAFFE	UVES (a), (b) or (c) + ARGUS

2.4 Limitations and Caveats

FLAMES is a complex instrument because of the different modes available and the multi-object capability. In order to operate it efficiently, a number of limitations had to be imposed.

- **The observer is responsible for the accuracy of the input catalogue. A relative accuracy of better than 0.3 arcseconds (rms) is required to limit the losses due to fibre-object mismatch. VLT guide star and fiducial stars must have coordinates in the same reference system as the objects.**

No cross check of the coordinates supplied by the user is performed by ESO. The quality of the astrometry remains fully the observer's responsibility. **Common errors include using a mix of astrometric systems, not correcting for stellar proper motions and assuming that bright stars always have accurate coordinates.**

Figure 2 shows the amount of flux lost in a MEDUSA fibre as a function of seeing and fibre-to-object decentering (in fraction of arcseconds); it is evident as bad coordinates may spoil completely the predicted performance. The reader should consider the full implications of the statistical meaning of the astrometric accuracy; if it is too bad, some of the objects will not get light at all!. This factor is even more important for the UVES fibres which are 1.0 arcseconds in diameter as opposed to 1.2 arcseconds for MEDUSA fibres.

- Given the high number of possible configurations, the spectral format is fixed for both GIRAFFE and UVES: no CCD binning, only one CCD readout speed in service mode and a possibility to use a fast readout mode in visitor mode only, no tuning of the wavelength, no change in resolving power are possible.
- Since the day-time calibration procedure is rather long (up to several minutes/setup, especially in the bluest setups) only a limited number of setups may be allowed per night, both in service and visitor modes.
- Screen flats in the blue are very time consuming and may not provide sufficient counts to flatfield the data well. Hence starting from P84, **ARGUS** settings HR1, HR2, HR3 and LR1 need to be observed in **visitor mode only**. This only affects Argus; all Medusa and IFU settings will continue to be observed in Service or Visitor mode.
- The atmospheric effects depend on the wavelength of observation. The VLT pointing and guiding is made for a given wavelength. While it is possible in p2 to specify two different observing wavelengths for the UVES and GIRAFFE fibres, **the VLT will point and guide only to the GIRAFFE wavelength in this combined mode**. This implies that the pointing will be correct, but if the airmass is changing drastically during the observations and the UVES and GIRAFFE wavelengths differ dramatically, then the UVES λ is disregarded and the UVES fibres may lose a considerable amount of light. For the same reason, it is important that if the observer wishes to observe the same objects at different wavelengths, two OBs (and therefore two different fibre positionings) are made, repositioning the fibres for the correct wavelength. **We finally note that in a combined observation, if the UVES part is more important, then the GIRAFFE configuration wavelength can be chosen to be close to the UVES wavelength e.g. H572.8 in the case of using UVES-580 nm. Of course, this would lead to entrance losses in the GIRAFFE part if the GIRAFFE observation wavelength is different from the above.**
- In general, long (e.g. longer than 60 minutes for most declinations, see § 4.4) and/or repeated observations of the same objects are better split in several observations made with different plates. Since the geometry of the field will slightly change with time, it is anyway recommended to reposition the fibres after each observation.

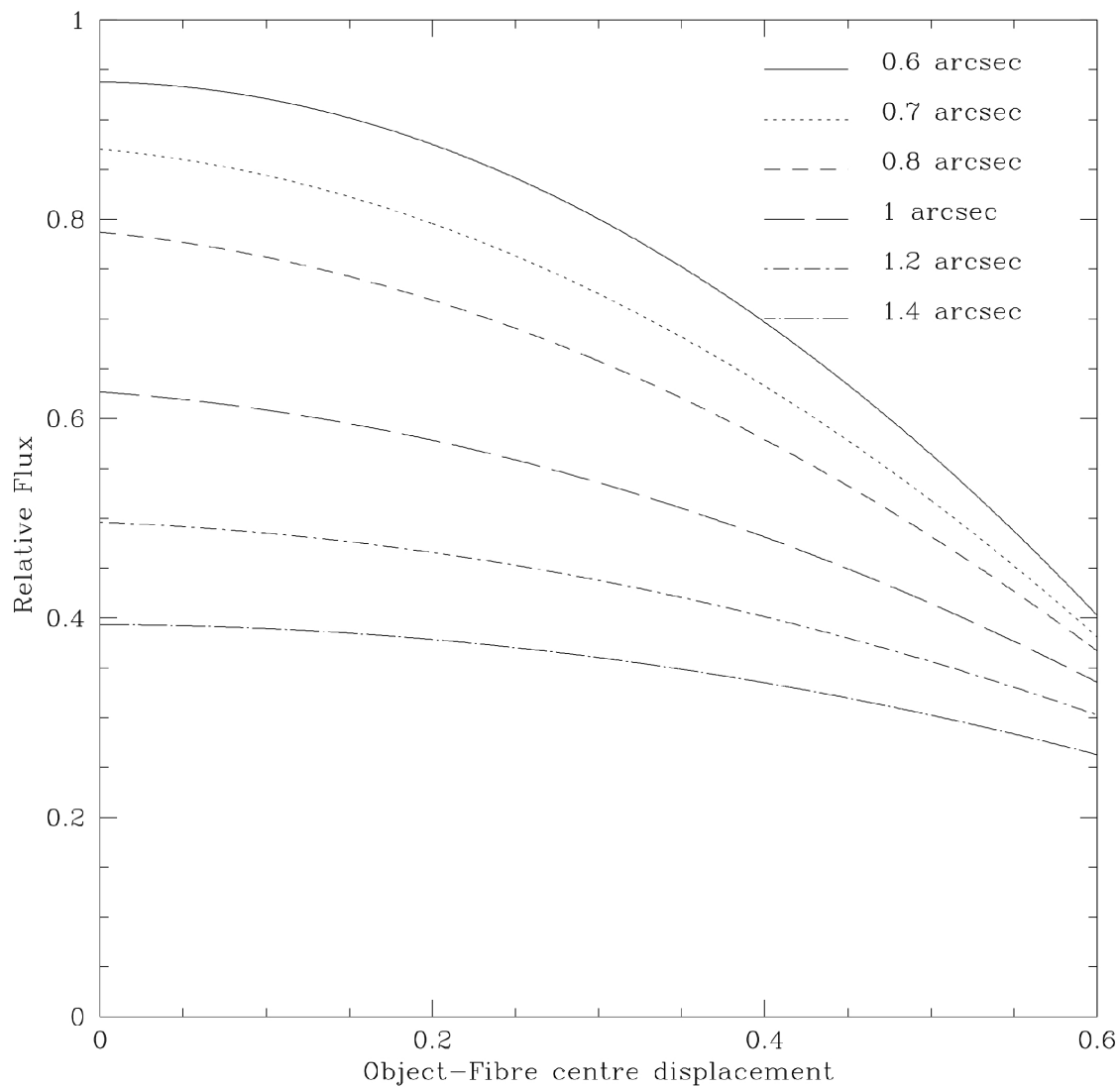

Figure 2: MEDUSA entrance losses as a function of seeing and object-fibre decentering. This plot shows how much flux can be lost due to bad astrometry. The reader should evaluate the impact of the astrometric errors in their full statistical sense.

- The positioning time is about 10 seconds/fibre, or 20 minutes for MEDUSA. This implies that OBs shorter than 20 minutes will suffer considerable deadtime before the next observation is started. In these cases, the duty cycle is very bad; another instrument is perhaps more suited for the observations. Note that, due to the implementation of the UVES slit, the positioning of the UVES fibres for the next observation cannot be done simultaneously with the current observations, but only after that the UVES shutter has been closed. Repositioning of UVES fibres requires 90 seconds in total.
- The UVES simultaneous wavelength Th-Ar lamp can accept exposure times in the range of 3 – 60 minutes for the 580 nm setup giving an acceptable level of exposure. Shorter or longer exposure times, however, will result in under (and over) exposed Th-Ar reference spectra, respectively. These will not be accepted in Service Mode. In the 860 nm setup long exposures would provide heavily saturated Ar lines, producing strong, persistent remnants. Neither the 860 or the 520 nm setups are offered with the simultaneous calibration option.
- All observations must be prepared with the FPOSS preparatory tool (See § 4.5 and 4.5.1 and the FPOSS manual). The Target Setup Files created by this tool must not be modified by the user. **This will cause the p2 process to fail.**
- The limited size of the MEDUSA and UVES fibres, together with the lack of information on the object-fibre displacement makes it impossible to compute the amount of flux lost; therefore no absolute spectro-photometry can be obtained with these fibre systems.

Unlike other multi-object ESO instruments, FLAMES does not have pre-imaging capabilities to prepare target selection. This implies that astrometric lists must be prepared by the observer. Experience with other similar instruments shows that most observation failures are due to improper target preparation. Also, given the relatively large field, atmospheric effects (e.g., differential refraction and its variations, see § 4.4) may be relevant, and the reader is asked to consider them carefully when preparing the observations.

2.5 FLAMES within the VLT Observatory

A detailed overview of the different instruments on the VLT is given on the ESO homepage under VLT Instrumentation:

<http://www.eso.org/sci/facilities/paranal/instruments/>

In the choice of the best instrument for a given observing programme, the following possibilities should be considered:

VLT instruments that can perform spectroscopy in the UV-Visual-Red-regions (300 – 1100 nm)

- **FORS2** at UT1 is an instrument operated at Cassegrain and has MOS capabilities and masks where up to 200 slitlets can be inserted. The highest resolution possible is ~ 6000 , although only with certain setups. See the FORS webpage for details at <http://www.eso.org/sci/facilities/paranal/instruments/fors/>

- **UVES** at UT2 is the instrument which is closest to FLAMES in terms of spectral resolution. In slit mode, the resolving power of UVES can be up to 120 000. The UVES red arm is also part of FLAMES, but its blue arm (300 – 500 nm) is not connected to FLAMES. When used in slit mode, with a dichroic blue and red spectra can be recorded simultaneously. This option is not available in UVES fibre mode with FLAMES.

When used in slit mode, the RED arm of UVES is about 2 times more efficient than the FLAMES fibre link. The multiplex advantage of using the FLAMES fibre link with respect to the slit mode can therefore be $\approx 3 - 4$ (depending if one or more fibres are dedicated to record the sky). This has to be considered just as a rough number, because the precise value will depend on the seeing and on resolving power adopted for UVES in slit mode.

GIRAFFE, in particular in IFU mode, can approach the typical resolution used with UVES, and its use can be considered as a valid alternative to UVES slit when several sources are present in the field and a very large wavelength coverage is not required.

UVES is equipped with a Iodine cell for accurate radial velocity measurements. While this system is likely more accurate than the multi-fibre system of FLAMES, it does not offer multiplex capabilities. The UVES iodine cell cannot be used in combination with the fibres because it is located in the focal plane of Nasmyth B, i.e., before the Fibre link to FLAMES. See the UVES webpage for details:

<http://www.eso.org/sci/facilities/paranal/instruments/uves/>

- **X-shooter** at UT3 is designed to cover the spectral range from ~ 300 – 2480 -nm at medium resolution. See the ESO website for the current status of this instrument:

<http://www.eso.org/sci/facilities/paranal/instruments/xshooter/>

2.6 High-resolution spectrographs at ESO La Silla

High-dispersion, echelle format spectrographs available at ESO La Silla include **HARPS** ($R \sim 110,000$) at the ESO 3.6m telescope. Information on these instruments can be found at <http://www.ls.eso.org/lasilla/sciops>

2.7 FLAMES Sample Observations and Calibrations

A large number of scientific observations of a variety of targets and their associated calibrations have been obtained during the FLAMES Commissioning and Science Verification runs. They have been made publicly available at:

<http://www.eso.org/sci/activities/vltcomm/flames/>

and

<http://www.eso.org/sci/activities/vltsv/flamessv/>

FLAMES calibrations are available from the ESO archive at <http://archive.eso.org/>.

2.8 Acknowledgment

The present maintainer of this document (B.Haeussler) is grateful to J. Smoker and the previous instrument scientists of FLAMES (J.C. Munoz, E.Bartlett, D. Gadotti, C. Martayan, C.Melo, A. Kaufer, R. Scarpa, D. Naef) as well as our colleagues at USD and QC, whose hard and competent work have contributed to making FLAMES a great facility.

2.9 Bibliography and Further Documentation

- [1] *FLAMES Templates Reference Guide*, VLT-INS-MAN-ITA-13750-0009,
(<http://www.eso.org/sci/facilities/paranal/instruments/flames/doc/>)
- [2] *FPOSS User Manual*, VLT-INS-MAN-AUS-13271-0079,
(<http://www.eso.org/sci/facilities/paranal/instruments/flames/doc/>)
- [3] *FLAMES Calibration Plan*, VLT-PLA-ESO-13700-3248,
(<http://www.eso.org/sci/facilities/paranal/instruments/flames/doc/>)
- [4] *UVES User Manual* , VLT-MAN-ESO-13200-1825,
(<http://www.eso.org/sci/facilities/paranal/instruments/uves/doc/>)
- [5] *P2PP3 Users' Manual*, VLT-MAN-ESO-19200-5167
(http://www.eso.org/sci/observing/phase2/MANUAL/p2ppman_v8.pdf)
- [6] *Mechanical features for the OzPoz positioner for the VLT*, Gillingham et al. 2000, SPIE conference
(<http://www.eso.org/sci/facilities/paranal/instruments/flames/doc/>)
- [7] *Installation and commissioning of FLAMES, the VLT Multifibre Facility*, Pasquini et al. 2002, The Messenger 110, 1
(<http://www.eso.org/sci/publications/messenger/>)
- [8] *Installation and first results of FLAMES, the VLT multifibre facility*, Pasquini et al. 2002, SPIE conference
(<http://www.eso.org/sci/facilities/paranal/instruments/flames/doc/>)
- [9] *The Data Reduction Software for GIRAFFE, the VLT medium resolution multi-object fiber-fed spectrograph*, Blecha et al. 2002, SPIE conference
(<http://www.eso.org/sci/facilities/paranal/instruments/flames/doc/>)
- [10] *Toward accurate radial velocities with the fibre-fed GIRAFFE multi-object VLT spectrograph*, Royer et al. 2002, SPIE conference
(<http://www.eso.org/sci/facilities/paranal/instruments/flames/doc/>)
- [11] *Quality Control of VLT-FLAMES/GIRAFFE data*, Hanuschik et al. 2004, SPIE conference
(<http://www.eso.org/sci/facilities/paranal/instruments/flames/doc/>)

2.10 Glossary

Acquisition: Accurate positioning of the telescope in order to center the target on the spectrograph slit.

BIAS frame: Read-out of the CCD detector of a zero seconds integration time exposure with shutter closed. The registered number of electrons per pixel has to be subtracted from a science exposure, because these were not created by photons from the source.

Calibration: Procedures to remove the instrumental signature from the scientific data (e.g., subtract BIAS frames and divide by the flatfield).

Camera: GIRAFFE and UVES have dioptric cameras imaging the dispersed parallel beams on the respective CCD detectors.

Charge-Coupled Device (CCD): Electronic 2D-array detector converting photons into electrons.

Cross-disperser grating: An echelle spectrograph contains two dispersive elements. One is the echelle grating, the other one is called the cross-disperser grating. UVES hosts two cross-dispersers, each with two different gratings. The cross-disperser grating determines the distance between the echelle orders.

Decker: Reflecting and movable blades placed in front of the slit and determining its length.

FACB: Fiducial Acquisition Coherent Bundles. These are 4 bundles of coherent fibres to take images of 4 reference stars and link the telescope to the targets.

Flatfield (FF): Spectrum obtained from light source with a flat (i.e. without spectral features) energy distribution, e.g. a tungsten lamp. The registered signal provides information about the response of the detector, allowing a determination of the variation in sensitivity from pixel to pixel, the echelle order shape, the presence of bad columns on the detector, etc.

Free Setting: A setting of the instrument defined by the observer, generally with a different wavelength, readout or binning than any of the standard settings. No free settings are available with FLAMES.

Grating: The main light dispersing elements of UVES and GIRAFFE are echelle gratings.

Guide star: A point source used for accurate tracking (and active control of the telescope mirrors) ideally with magnitude between $R \sim 9$ and $R \sim 11$. ARGUS allows $R \sim 12$ as a fainter limit.

Maintenance: Technical procedures developed to control and maintain the quality of telescope, instrument, and detector.

Observation Block (OB): A logical unit of exposures needed to obtain a coherent set of data. Encompasses all relevant information for a successful data acquisition on a target. It consists of target information, a set of templates, parameter files for the templates, conditions, requirements and comments concerning the specified observations. It represents the entity the short-term scheduler deals with. Constructing Observation Blocks is part of the Phase II Proposal Preparation Process.

Order Separation Filters: In GIRAFFE the wavelength range covered in each setup is defined by using filters as predisperser: inserted in the beam they reject all the light outside the defined bandpass, which instead is dispersed by the echelle grating.

Phase II Proposal Preparation (P2): During this phase the successful applicant (whose Phase I proposal has been accepted based on the scientific rationale and technical feasibility) prepares the Observation Blocks to carry out the observing programme.

Focal Plates: The Fibre Positioner can host up to 4 plates: these are metallic spherical surfaces where the fibre buttons are positioned for the observations. Only two plates are only currently in use.

Pre-slit area: UVES optical elements located in front of the spectrograph slits.

Spectrograph arm: UVES consists of two “separate” spectrographs, one optimized for the blue (blue arm) and one for the red wavelength region (red arm). Only the red arm is connected to the fibres.

Spectrograph slit: Two parallel, reflecting metal blades with an adjustable separation (slit width) form the entrance slit of the spectrograph. The image of the astronomical source produced by the telescope is focused on the slit plane.

Standard Setting: A pre-defined setting of the instrument facilitating the preparation of the observations. The Observatory keeps an updated database of the relevant calibration files for all Standard Settings of the instrument.

Template: A set of instructions for the performance of a standard operation on an instrument, typically an instrument and detector setups. The templates represent specially devised sequences for all instrument operations and calibrations.

Template Signature File: This file is a description of a Template and its parameters. It contains information about the type and allowed ranges of the parameters; some of the parameters have to be set by the observer.

Wavelength calibration: Spectrum obtained from a reference emission-line lamp (e.g. Th-Ar). The wavelengths of the (many) emission lines are accurately known and are used to transform pixel space into wavelength space.

2.11 Abbreviations and Acronyms

AT	Acquisition Template
BOB	Broker for Observation Blocks
CAL	Calibration exposure
CCD	Charge-Coupled Device
CD	Cross-disperser
ESO	European Southern Observatory
ETC	Exposure Time Calculator
FLAMES	Fibre Large Array Multi Element Spectrograph
FPOSS	Fibre Positioner Observing Support Software
FRD	Focal Ratio Degradation
IFU	(deployable) Integral Field Unit
OB	Observation Block
OS	Observation Software
P2	Phase II Proposal Preparation
RTD	Real Time Display
STD	Standard star
SM	Service Mode
TSF	Template Signature File
UVES	Ultraviolet and Visual Echelle Spectrograph
VLT	Very Large telescope
VM	Visitor Mode

3 FLAMES Characteristics and Sub-Systems

3.1 Opto-mechanical Layout

Figure 3 is a view of two of the main components of the FLAMES facility, the Fibre Positioner and GIRAFFE, as seen from the telescope centerpiece on the telescope platform.

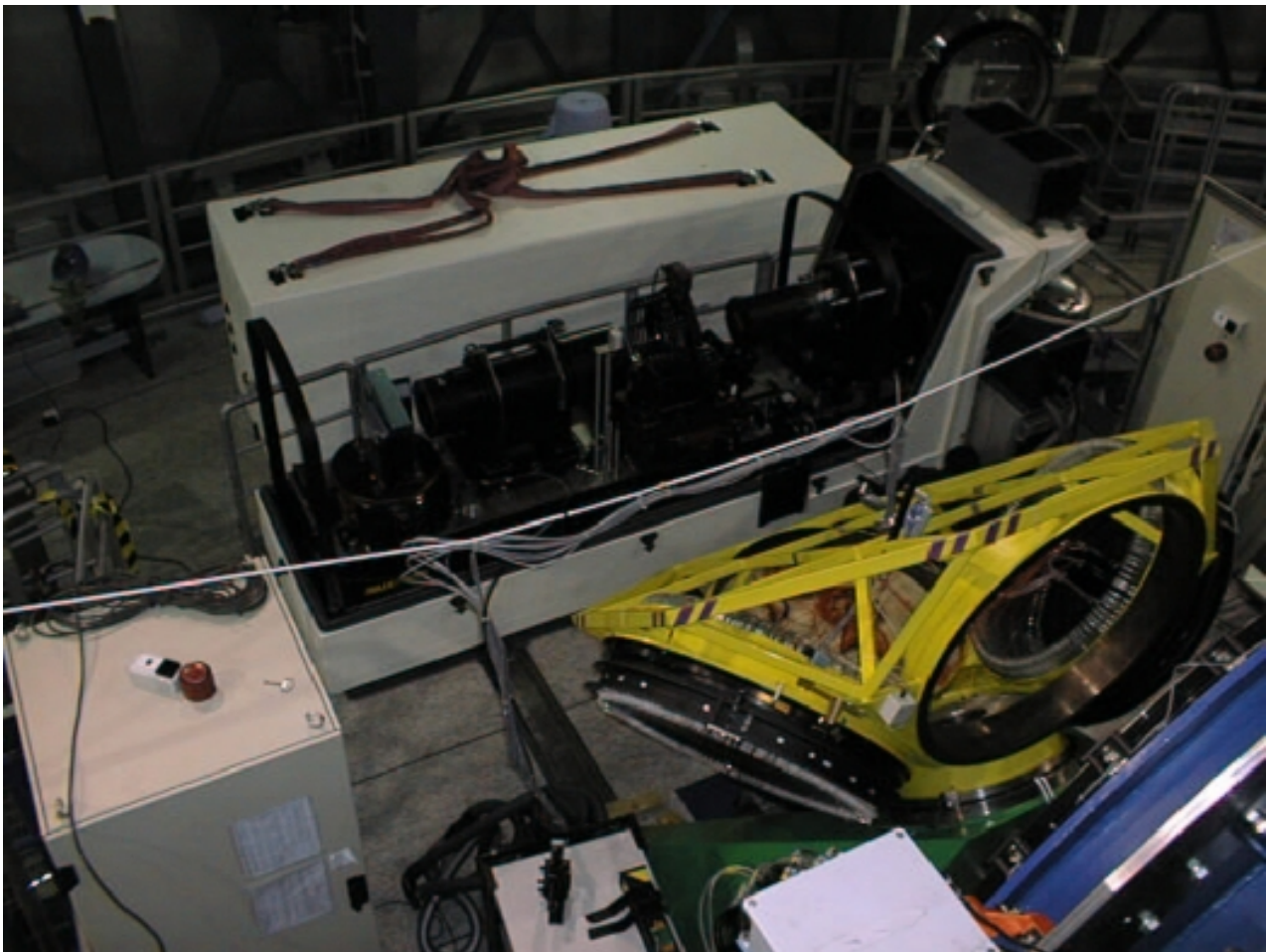

Figure 3: The Fibre Positioner and GIRAFFE as seen during the GIRAFFE integration on the Nasmyth platform. The picture was taken from the telescope. The positioner is looking towards the Nasmyth Focus, where the corrector is placed, and on the lower left the positioner electronics cabinet is seen. GIRAFFE is opened, and the optomechanical components are visible.

The instrument consists of five main parts. The first part is the **corrector** which is mounted on the rotator. The second part is the fibre **positioner** which allocates the fibres on the two plates mated to the Nasmyth adaptor-rotator. The positioner also hosts the calibration lamps used to obtain flat-field and wavelength calibration spectra. Furthermore, it is equipped with a secondary astrometric and guiding system (FACBs) which consists of four imaging fibre bundles correcting small mismatches between the VLT and the observer coordinate system. These first two components are common to all FLAMES configurations.

The light is collected through fibres equipped with microlenses into different **fibre systems**: two for UVES (one per plate) and five for the GIRAFFE spectrograph (two for MEDUSA,

Table 4: Full Corrector transmission as function of wavelength and radial distance of the object from center (in arcminutes). It includes as well pupil decentering effects for a MEDUSA aperture.

Wave [nm]	Distance from optical axis [arcmin]							
	0	2	4	6	8	10	11	12
365	0.789	0.788	0.788	0.784	0.776	0.754	0.735	0.692
405	0.894	0.890	0.888	0.888	0.881	0.842	0.848	0.802
486	0.919	0.912	0.906	0.902	0.903	0.900	0.890	0.847
586	0.914	0.905	0.897	0.890	0.889	0.895	0.887	0.856
656	0.898	0.887	0.879	0.871	0.869	0.879	0.872	0.842
800	0.880	0.869	0.858	0.849	0.846	0.854	0.854	0.826
1014	0.843	0.830	0.819	0.809	0.805	0.811	0.816	0.792

two for IFUs, and one for ARGUS). The different fibres have different diameters and lengths and are organized in different slit systems, each feeding the spectrographs.

Finally the light reaches the last two components: the **UVES (RED)** and the **GIRAFFE** spectrographs, where it is dispersed and detected.

The next sections describe the FLAMES subsystems as one follows the optical path going from the telescope to the instrument detectors. It is intended to guide the user in the selection of the optimal instrument configuration for the observing programme. The functionalities of the different subunits are explained and reference is made to their measured performance.

Efficiencies (e.g., in the form of transmission curves) of the main instrument components including the CCDs are available in the FLAMES database accessible through the GIRAFFE and UVES Exposure Time Calculators (see § 4.7.1).

3.2 Corrector

The optical corrector is a doublet of BK7 equivalent lenses of 900 mm diameter. In order to maintain a good transmission over a large wavelength range, the lenses have been coated with a single layer of Mg₂.

The function of the corrector is to give an excellent image quality over the whole 25 arcmin FLAMES field of view and to provide a pupil located at the center of curvature of the focal plate.

The corrector is mounted with a cross support onto the Nasmyth adaptor-rotator. The support also hosts the three attaching points for the Positioner fibre plates.

When the whole optical train is taken into account (including telescope optics and vignetting), the effective transmission of the corrector depends on the observing wavelength and on the distance of the object to the field center, as expressed in Table 4.

The corrector, and therefore the FLAMES plates, are positioned in the optical path AFTER

the VLT guide probe. This implies that the guide probe will vignette the field of view. It is therefore very important to select carefully the VLT guide star. VLT guide star should have an R magnitude between $R \sim 9$ and $R \sim 11$ for optimal performance (For ARGUS observations the faint limit is $R \sim 12$). Although fainter objects (to $R \sim 13$) *may* work, experience has shown that due to uncertainties in the magnitude and non-ideal observing conditions (e.g. cirrus or poor seeing), the Active Optics loop may fail to close. If this occurs, then another guide star would need to be chosen that would likely vignette the fibres on the plate.

Finally, it is also very important that the guide star is sufficiently isolated to avoid confusion in its choice.

Note that FLAMES does **not** have an atmospheric dispersion corrector.

3.3 Fibre Positioner (OzPoz)

The Fibre Positioner (“OzPoz”) is at the core of the FLAMES facility. OzPoz is a rather large and complex system equipped with four plates, two of which are currently in use (see Figure 3). The Positioner can be subdivided into the following subsystems:

- Plates: Two metallic dishes, on which the magnetic buttons holding the fibres are attached. Each of the plates has a hole in the center. In one plate (plate 2), this hole hosts ARGUS. Each plate has a curvature of 3950 mm, to match the curvature of the corrector focal plane. The corrector also places the telescope exit pupil at the center of curvature of the plate, so fibres receive the full telescope beam regardless of their position on the plate.
- Retractors: Mechanical systems maintaining the fibres in constant tension. Each fibre is equipped with one retractor. The retractors are the same for all fibres. When parked, the fibres are deposited and left on a porch located just outside the plate. The disposition of the fibres on the plate(s) is similar, in that MEDUSA, UVES, FACB, IFU, and IFU sky retractors are disposed in the same way on the two plates; every even-numbered retractor is a MEDUSA one.
- Trolley: Main structure holding the plates. The trolley can perform two main movements: it can approach (or retract) the Nasmyth adaptor-rotator to engage the plate (or disengage it). Furthermore it can rotate the structure holding the plates in order to exchange the plates between the adaptor-rotator and the positioner robot.
- R- θ system and gripper (“robot”): This unit is at the very core of the whole system. It grips and releases the magnetic buttons at the positions reached via the R- θ (polar) robot. The gripper requires a back-illumination system, that means some light shining through the fibres from the spectrograph towards the plate. A video system records this back-illumination light and performs an image analysis for two purposes: first to reach the required high position accuracy of the optical center of the fibre button and second to detect if the magnetic button is properly picked by the gripper and properly released on the plate. The polar coordinates of a placed fibre are stored in an internal permanent memory (“NVRAM”) and are used for the next positioning.
- OzPoz is equipped with a calibration box, which moves with the gripper. This calibration box hosts an optical system which directs the light either from a tungsten lamp, or

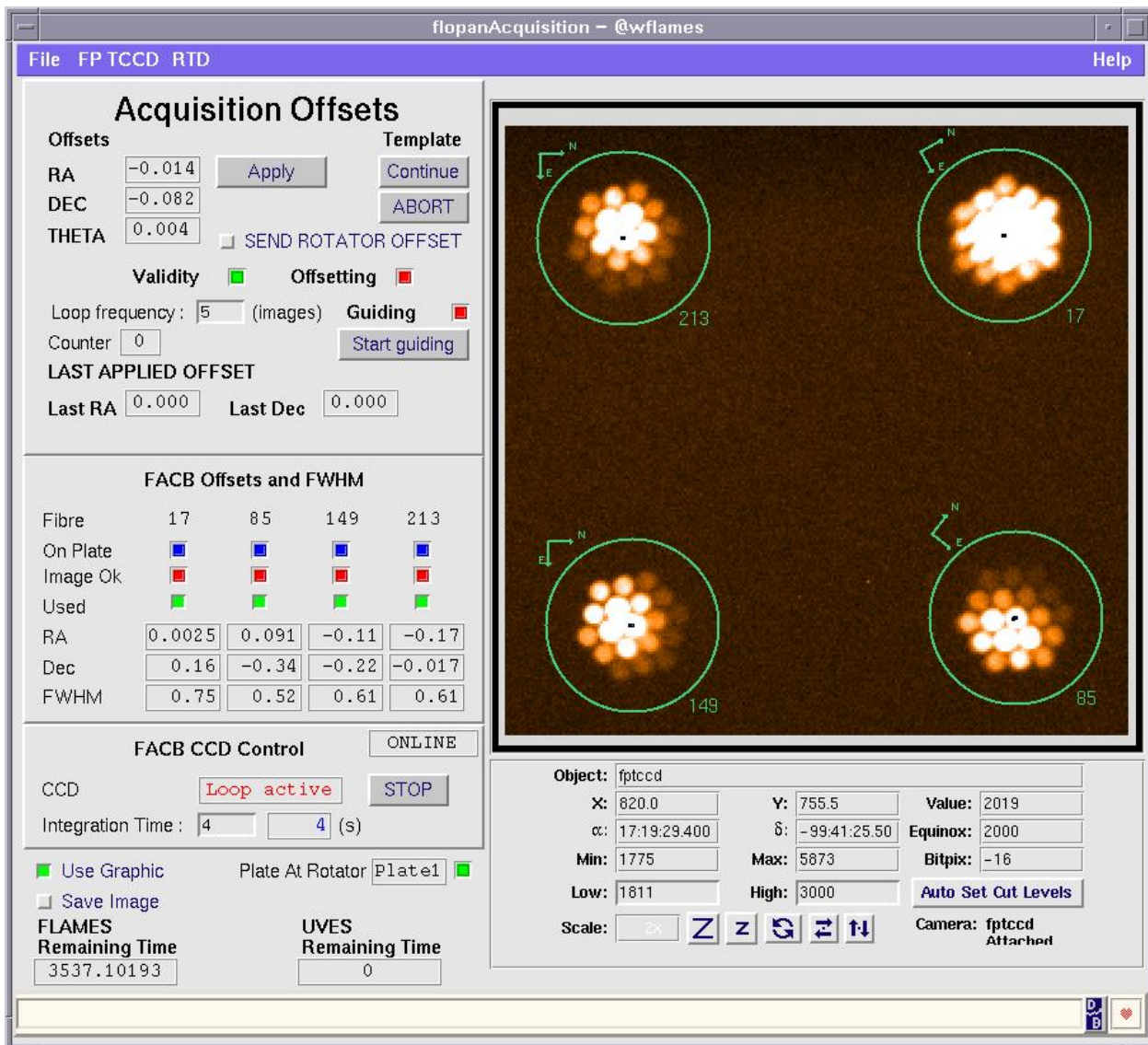

Figure 4: Image of four fiducial stars as seen in the Technical CCD through the 4 Fiducial Acquisition Bundles (FACBs). Each bundle is composed of 19 ordered fibres, which image the stars on 4 parts of the TCCD. Each FACB has an effective diameter of 2.4 arcseconds.

from a Th-Ar lamp, or from a Ne lamp into a fibre. In this way FF, Th-Ar and Ne calibrations can be obtained for GIRAFFE and for UVES. The procedure to acquire these calibrations is to first position the fibres to be calibrated on the plate in a given pattern (typically along a spiral pattern) and then to sweep with the gripper over the buttons, illuminating one fibre after the other, one by one. For FF calibration the procedure is to sweep continuously over the buttons, illuminating them several times, while for the Th-Ar calibrations the gripper stops over each fibre for a number of seconds specified by the user.

- **Field Acquisition Coherent Bundles (FACBs):** Four magnetic buttons are equipped with a system of 19 coherent fibres each. This bundle of fibres is used to obtain images of “fiducial” (or reference) stars, one per bundle. The four images are recorded on an ESO technical CCD (TCCD); the image centroids are computed and the proper offsets are calculated to center the fiducial stars into the bundles. **These 4 fiducial stars**

represent the link between the sky and the plate coordinates, therefore it is absolutely necessary that they are chosen carefully: They must be sufficiently isolated, in the same coordinate system as the target stars and of visual magnitude brighter than $R = 15$. Given the limited dynamical range of the Technical CCD, the FACB stars should be within a range of 3 magnitudes. Each FACB bundle has an effective diameter of $2.4''$. An example of a TCCD image with the four stars in the FACB bundles is shown in Figure 4. A TCCD snapshot is automatically taken automatically once the acquisition is done.

- Positioning Software: This is based on a well-tested and complex code developed initially for the 2dF system at Anglo-Australian Observatory (AAO). This so-called “delta”-task allows crossing of the fibres in their final positions and determines the button movements sequence from a given fibre configuration to the next (solving a traveling salesman problem). It is worth noticing that to reach a new complex configuration more than one move per fibre may be needed. A more detailed explanation can be found in the FPOSS manual.

3.3.1 Positioner Performance Characteristics

The main performance characteristics of the Fibre Positioner can be summarized as follows.

1. Mechanical Positioning accuracy: better than 0.08 arcsec.
2. Positioning time: 6 seconds/move. The whole configuring time also depends on the number of moves necessary to re-configure the plate, that is, the number of moves per fibre needed to re-position one button, as well as by the number of attempts per button needed to achieve the required positional accuracy.
3. Possibility to configure the next observation while observing.
4. Plate Exchange time: maximum 180 seconds (w/o considering field acquisition). Further tasks are carried out before and after a plate exchange, however.
5. Calibration unit equipped with Th-Ar, Ne and FF lamps
6. Performing fine centering of the plate on the sky with FACBs.
7. Minimum button separation 11 arcseconds (button diameter: 10 arcsecs).

3.4 Buttons and Fibre Systems

FLAMES is equipped with different types of fibres for UVES and for the different modes of GIRAFFE. At the output of the fibre system, individual fibres are arranged in different subslit systems depending on the fibre type. Each GIRAFFE mode has five fibres per slit devoted to **simultaneous wavelength calibration**, in addition to the fibres coming from the Positioner. These fibres provide five calibration spectra for each observation acquired with GIRAFFE. The UVES system has a similar simultaneous calibration capability: in that case, one of the eight fibres is reserved for calibration.

In the evaluation of the instrument performance it has to be considered that among such a large number of fibres some dispersion exists in the fibre transmission. Fibre transmission within the GIRAFFE F/5 and UVES F/10 apertures have been measured for every single fibre, and the distribution of the transmission is given in Figure 5 for the different fibre types.

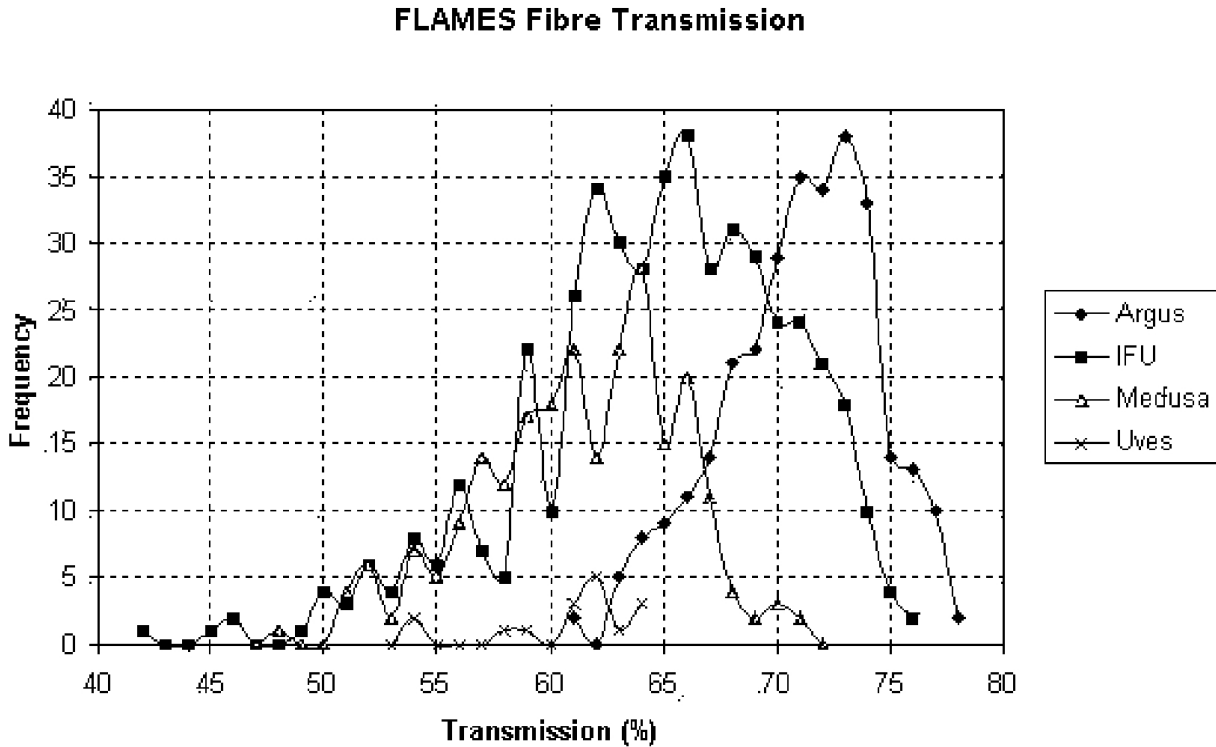

Figure 5: Distribution of the transmission of the FLAMES fibres at 600 nm. each fibre has been measured in laboratory.

3.4.1 Magnetic Buttons

The Magnetic Buttons have two purposes: first, they are the mechanical means which allows the fibre end to be placed on the plate in front of the stellar target. Second, they are the support of the optical interface between the telescope beam and the fibre. A magnet glued at the base of the button enables the fibres to be placed on the curved plate. The diameter of the stainless steel button is 6 mm (10.3 arcsec), but in order to avoid collisions between the buttons, the minimum allowed separation of two buttons is set to 11 arcsec. The magnet is a tablet of 4 mm diameter and 1.2 mm high. The magnetic attachment force is around 235 gr.

Single microlenses for MEDUSA and UVES fibres and arrays of microlenses for ARGUS and the IFUs are used to reduce the F/15 telescope beam to around F/5 into the fibres. These lenses image the pupil of the telescope onto the fibre entranced surfaces. This system helps to scramble the photometric variations produced by oscillations of the star on the fibre by guiding errors. In the case of MEDUSA and UVES fibres, the optics are rod lenses with their image focal plane on the flat surface. The lens has been cut to 45 degrees to fold the telescope beam into the fibre, parallel to the plate. In the case of ARGUS and IFUs, all arrays of microlenses are glued to a single total reflection 45 degrees prism.

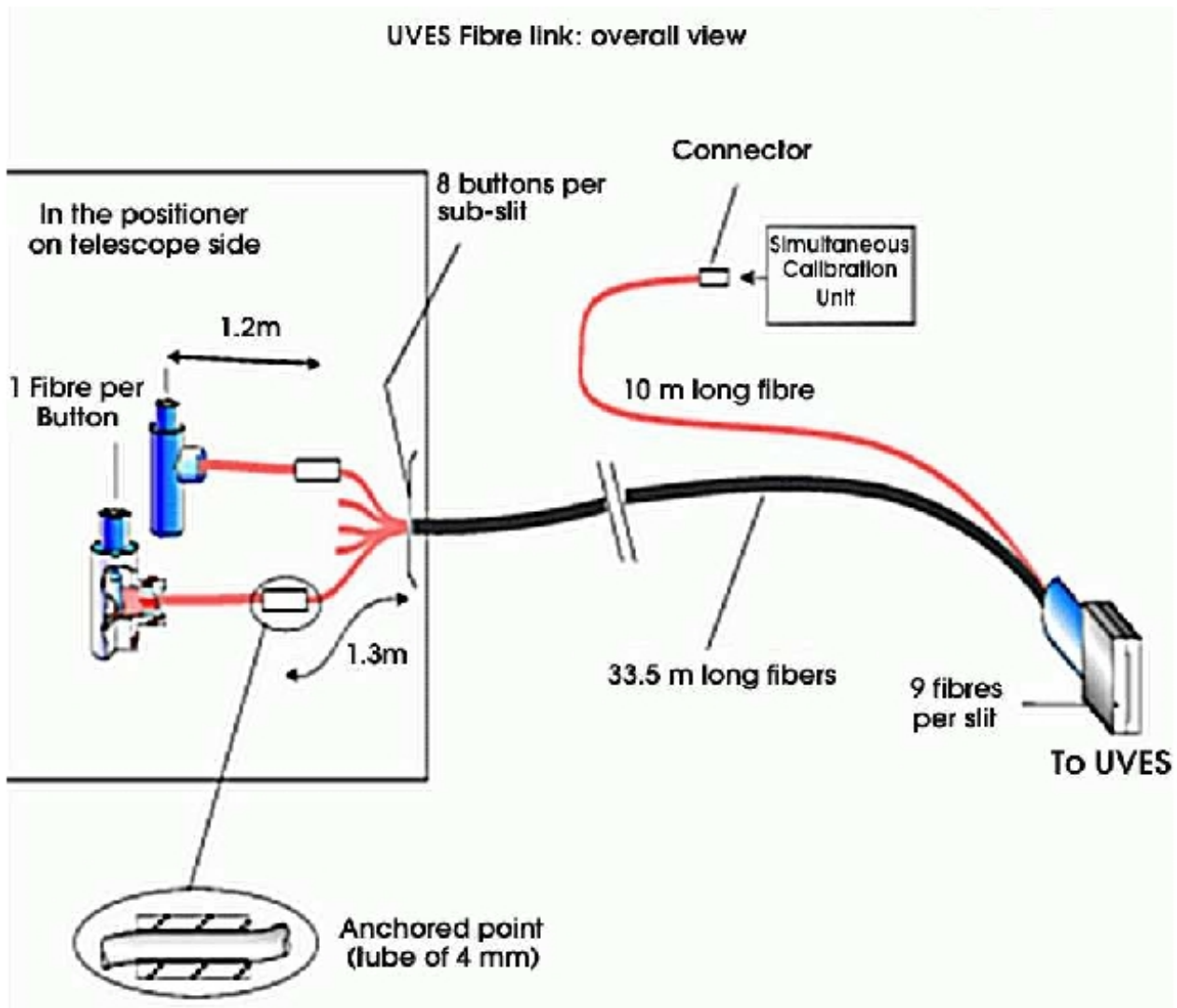

Figure 6: Scheme showing the buttons, fibre bundles, and the geometry of the UVES slit.

3.4.2 UVES Fibres

Each of the positioner plates hosts eight ~ 54 -metre long fibres (the above graphics wrongly indicates 33.5m) which bring the light to the UVES spectrograph on the Nasmyth platform B.

The UVES fibre concept is shown in figure 6: there are two bundles (one per plate), each with eight buttons. Every button hosts one fibre. From the UVES simultaneous calibration box, one additional 5-meter fibre reaches the UVES-fibre slit.

Each of the two UVES-fibre slits (one per plate) consists of 9 fibres, although **only eight fibres can be used simultaneously**. Since September 11, 2012, Fibre 37 on plate 2 has been disabled, see Section 4.6.

They have a core of 120 microns diameter and a cladding of 144 microns. Each fibre is protected by a Polyamide jacket of 180 micron diameter. The fibre to fibre separation (center to center) is 1.7 times the fibre core (1.7 arcseconds).

The UVES system works at the optimal $F/3$ focal ratio, to minimize the focal ratio degradation (FRD) and therefore the transmission losses. The exit is also at $F/3$; each fibre has an aperture

Table 5: UVES fibre transmission. The values given here include all losses, focal ratio degradation, optics and coupling. For wavelengths redder than 600 nm the transmission is constant. **Variations of a few tens percents between different fibres have been measured, see Figure 5, but individual fibres are very stable .**

Fibre	370 nm	400 nm	450 nm	600 nm
UVES	0.36	0.41	0.52	0.61

of 1 arcsecond on the sky. A microlens in front of the fibre converts the F/15 focal ratio of the VLT Nasmyth focus to F/3; behind the microlens the light is reflected towards the side of the button, where the entrance of the fibre is located (see Figure 6). The overall transmission of the UVES fibre system is given in Table 5.

The fibres of each plate are arranged in one subslit (see Figure 6). The nine fibre centers are separated by 1.7 times the fibre core diameter, implying that there is some degree of contamination between adjacent fibres. This contamination can be largely reduced by extracting the spectra on the central six or seven pixels. Diffuse light is present, and since this depends on the overall light injected into the spectrograph, the observer should be careful not to expose objects of too different spectral type and/or luminosity if absolute spectroscopy is desired.

The simultaneous calibration fibre is the last one on the slit (Figure 6). The two subslit centers are separated by 500 microns, (see Figure 6), therefore spectra obtained with different plates are shifted by ~ 40 pixels in the spectral direction on the CCD.

3.4.3 MEDUSA Fibres

Each plate also hosts 132 MEDUSA fibres. Each button includes a single fibre and its construction is similar to that of UVES. In the case of MEDUSA, the used focal ratio is F/5. The core of each MEDUSA fibre is 230 microns, which corresponds to an aperture on the sky of 1.2 arcsecs. They have a cladding of 253 microns and a protection buffer of 280 microns. The MEDUSA fibres are 13 meters long and their typical overall transmission is given in Table 6.

Fibre	370 nm	400 nm	450 nm	600 nm
MEDUSA	0.47	0.52	0.55	0.61
ARGUS	0.52	0.58	0.62	0.70
IFUs	0.49	0.55	0.58	0.66

Table 6: GIRAFFE Fibre Transmission: The values given here include all losses, focal ratio degradation, optics and coupling. For wavelengths redder than 600 nm the transmission is constant. **Variations of a few tens percent between different fibres are measured, see Figure 5, but individual fibres are very stable .**

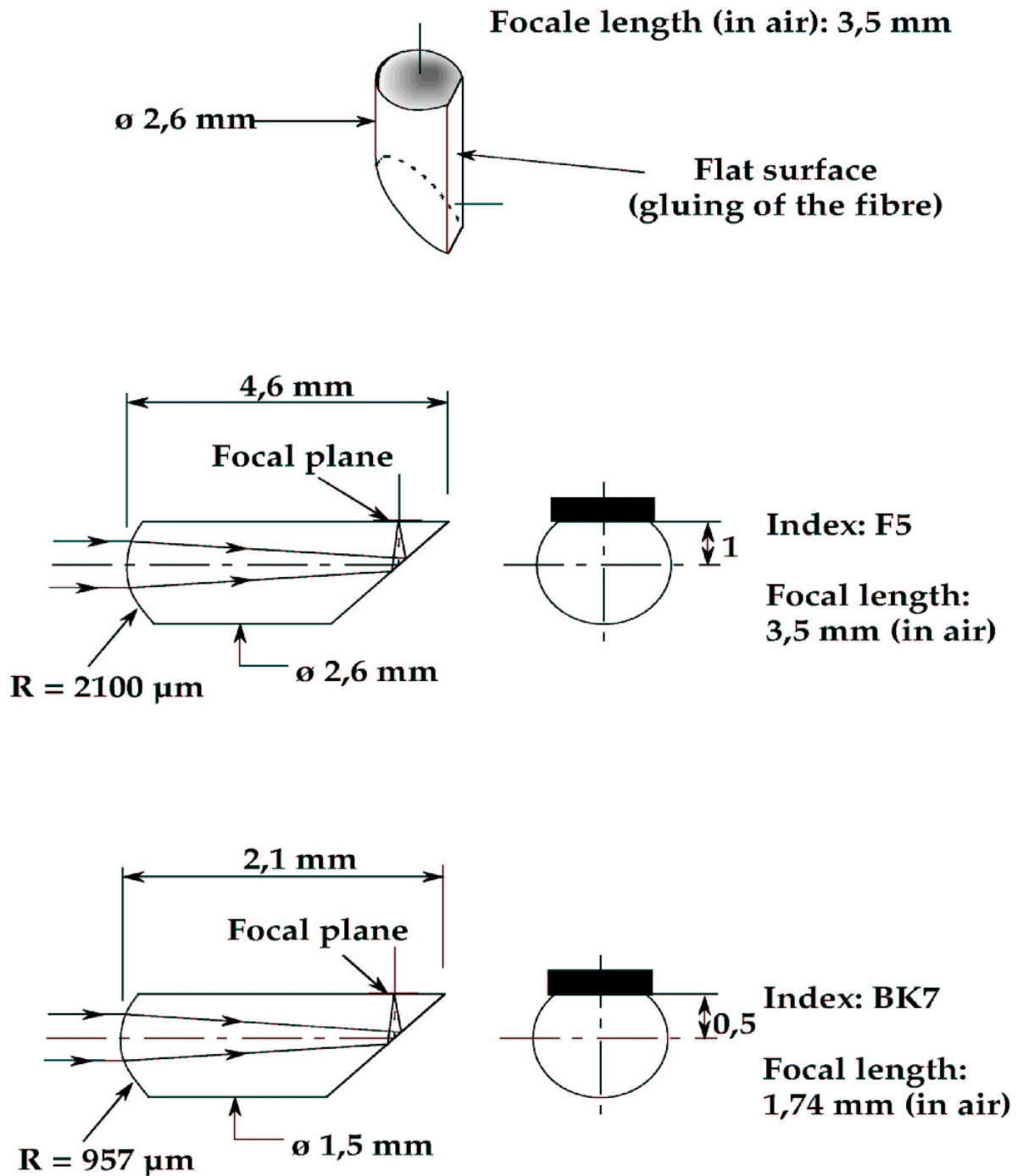

Figure 7: Scheme of the different microlens concepts.

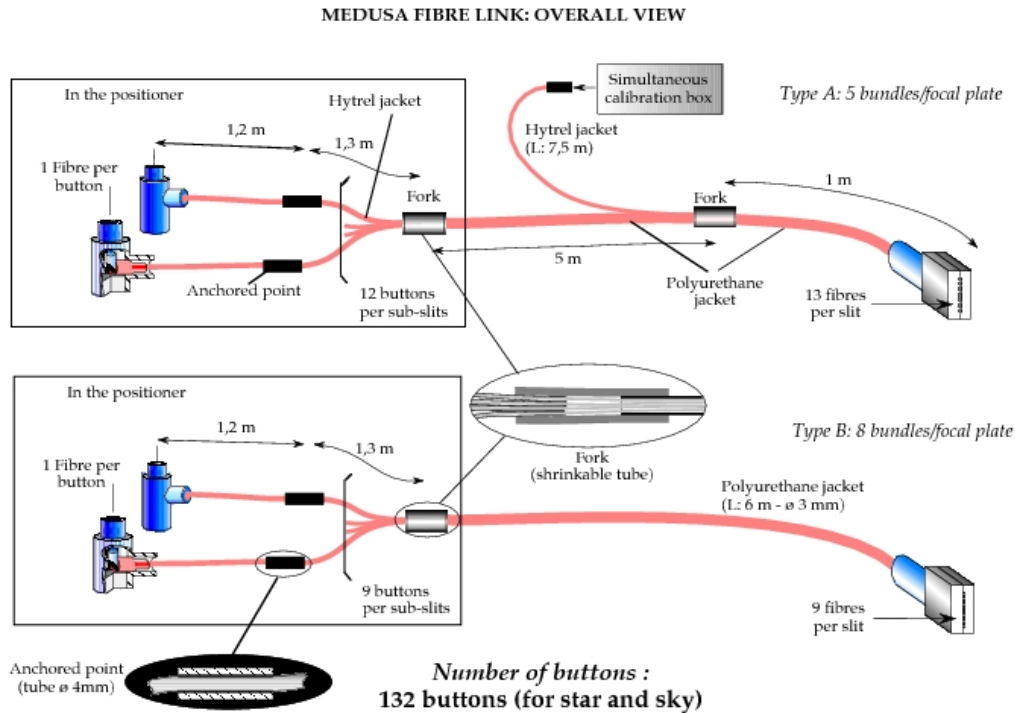

Figure 8: Scheme showing the buttons, fibre bundles, and the geometry of the MEDUSA slit.

They are organized in a slit composed of several subslits. The MEDUSA subslits are of two types: a) eight subslits hosting nine object-fibres and b) five subslits hosting thirteen (twelve object + one simultaneous calibration) fibres. This fibre slit follows the curvature of focal plane of GIRAFFE. The center-to-center distance of the MEDUSA fibres is of 2.26 times the fibre core diameter: this ensures a fibre-to-fibre contamination below 0.5%.

3.4.4 IFU Fibres

Each Integral Field Unit (IFU) button is composed of twenty microlenses arranged in a rectangular shape (see Figure 1). The microlenses are 0.52" squares. They convert the F/15 beam of the VLT to an F/7 focal ratio. Due to the focal-ratio degradation (FRD) in the fibres, the effective focal ratio at the fibre exit is F/5. The movable (or “deployable”) IFUs are a unique characteristics of GIRAFFE. These devices can be placed all over the FLAMES field of view with the exception of the very center of the plate.

Underneath the microlenses, a totally reflecting LLF1 prism sends the light to the fibres. Each IFU contains twenty associated single fibres and each plate hosts fifteen IFUs. In addition, 15 Sky IFUs are present on each plate. They are identical to the object IFUs, with the exception that only 1 fibre takes the light from the central microlens.

The fibres of each IFU are organized in a special way on the microlens array, to guarantee the maximum of contiguity between fibre exit and fibre input. The output of the twenty IFU fibres plus the Sky IFU fibre constitute an IFU subslit (with therefore twenty-one fibres). In total, the IFU slit is composed of fifteen subslits. In addition, five subslits contain in addition a calibration fibre fed by the GIRAFFE simultaneous calibration box.

The center-to-center distance between the fibres in the subslits is only 1.47 times the fibre diameter core, which implies that the contamination between adjacent fibres is rather high

(about 10%); in any case, an even higher level of contamination is always present at the fibre entrance level in normal observing conditions.

3.4.5 IFU Orientation

Fibres are kept in constant tension by the springs in the retractors, and the buttons are free to float in the gripper before being placed. When a button is placed, the fibres are always oriented along the line which joins the position of placement and the retractor (parking position), as seen in the FPOSS mimic. This means that the IFUs are always oriented (within a few degrees) with the long side perpendicular to the conjunction fibre-retractor, that is, the long side of the IFU (3 arcseconds) is perpendicular to the fibre, the short (2 arcseconds) is oriented along the fibre-retractor direction. See Fig. 25. Fig. 26 shows which IFU fibre is which in the reconstructed image produced by the ESO pipeline.

3.4.6 ARGUS Fibres

The ARGUS system is a fixed array of 14×22 microlenses, similar to the IFUs, located in the center of Plate 2. ARGUS is further equipped with a focal enlarger system allowing to switch between a scale of 0.52"/microlens (1:1) to a finer scale of 0.3"/microlens (1:1.67). In addition to the object fibres, fifteen ARGUS Sky fibres are available on the plate; they are built identical to the IFU Sky fibres, i.e., with only the central fibre present. The ARGUS array is best flatfielded using attached (screen) flatfields.

Fig. 9 shows the ARGUS array geometry and Fig. 23 reconstructed ARGUS images produced by the ESO pipeline.

3.5 GIRAFFE

GIRAFFE¹ is a fully dioptric spectrograph with a beamsize of 180 mm and is able to support the 76.8 mm longslits fed by the different GIRAFFE fibre systems. It has been conceived to minimize maintenance and night calibrations; special requirements were introduced to reduce setup shifts and to obtain accurate re-positioning. In this way, one is able to use calibrations obtained in the afternoon. Five fibres can be used to obtain simultaneous calibration spectra and to monitor the instrument drifts. After passing from the slit unit, the light is sent through the order sorting filters to the collimator. The collimated beam is dispersed by one of the two high (HR) or low (LR) resolution echelle gratings. After passing through the collimator again, an intermediate spectrum is produced. Finally the F/2 camera produces the image on the 2k×4k CCD (see Figure 12). A summary of the most relevant GIRAFFE characteristics is given in Table 7.

The different GIRAFFE sub-units are described in more detail in the following sections.

¹The GIRAFFE spectrograph obtained its name from the first concept for the instrument, in which it was positioned vertically on the Nasmyth platform.

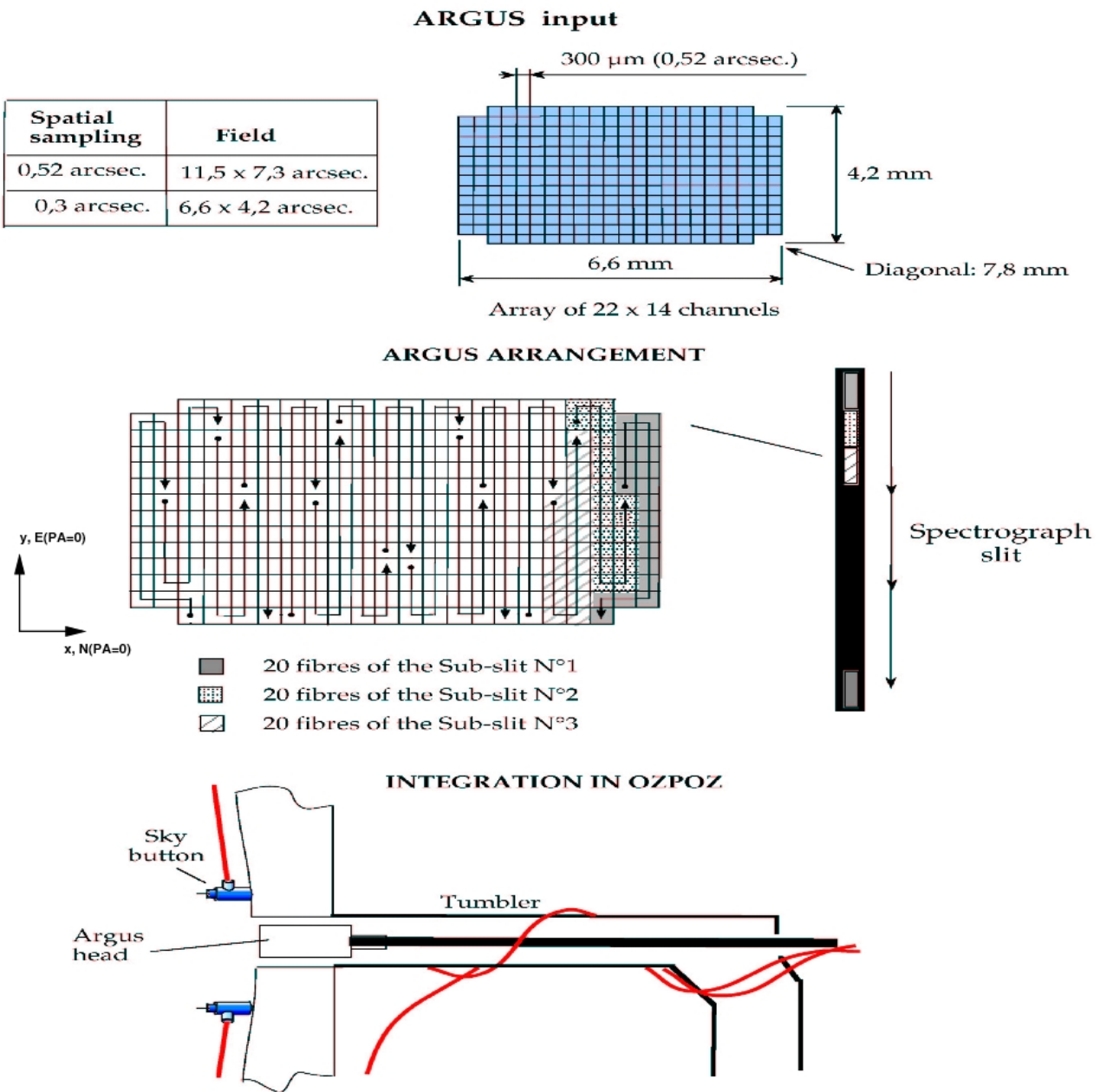

Figure 9: Geometry of the ARGUS microlens array. The arrows $\bullet \rightarrow$ indicate the orientation of the subslits in the array and the direction of the increasing number of the fibre's position in the subslit (PSSN) as given in the static Fibre Binary Table (cf. Section 6.5.2). The x and y coordinate system refers to the X and Y columns of the Fibre Binary Table with which the ARGUS image array is reconstructed from the fibre's position in the ARGUS slit (FPS). For a ARGUS position angle of PA = 0 the North-East orientation on sky is indicated for the reconstructed image, too. This is the long axis of ARGUS. See also Fig. 23.

Table 7: Summary of GIRAFFE spectrograph characteristics

Type	Echelle + Order selection Filters
Collimator beam	180 mm
Collimator aperture	F/5
HR Echelle	204 × 408 mm, 316 lines/mm, 63.4° blaze angle
LR Grating	156 × 204 mm, 600 lines/mm, 38° blaze angle
Camera Focal Length	360 mm (mean)
Detector	2048 × 4096, 15 μm EEV CCD
Scale	0.19 arcsec/pixel
Slit height	76.8 mm

3.5.1 Slit Unit

The slit unit contains six slots: five are occupied by the GIRAFFE fibres and one is occupied by the long slit which can be illuminated by an internal calibration unit. The slit unit is the most complex mechanical subsystem of GIRAFFE, because it needs a very high stability and reproducibility. Two movements allow to exchange the fibre slit and to set the fibres in focus.

In addition, the slit unit is equipped with a number of back-illumination LEDs. These LEDs are powered and controlled by the Fibre Positioner. They are used to allow the gripper camera to view the fibre output when positioning. Clearly, since they are lit during the GIRAFFE exposures, special care was taken in keeping them very well light-tight, in order not to create light contamination in the spectrograph. Thanks to this system, while one is observing with a set of fibres on one plate, any set of fibres on the other plate can be prepared by the positioner for the next observations.

3.5.2 Filters and the Filter Wheel

After the slit, an interferometric filter selects the light according to the chosen wavelength and resolution. In addition to excellent transmission and image quality, these filters must fulfill very stringent requirements on the bandpass edges and blocking over the whole CCD sensitive bandpass, in order to avoid pollution from adjacent spectral orders. This is very critical, especially in the blue where the orders are rather short in wavelength. The transmission curves for all filters can be found in the Appendix (Chapter 7).

The thirty GIRAFFE filters are mounted on a filter wheel with four layers, each with twelve filter positions. A filter is selected by selecting the one of the 4 layers (A-D) and one of the rotational filter positions (1-12).

3.5.3 Dioptric Spectrograph

After the light is passed through the filters it is reflected towards the collimator, which works in double pass, i.e., the light passes through it again after being dispersed. The configuration angle is six degrees. The main dispersers are two commercial echelles:

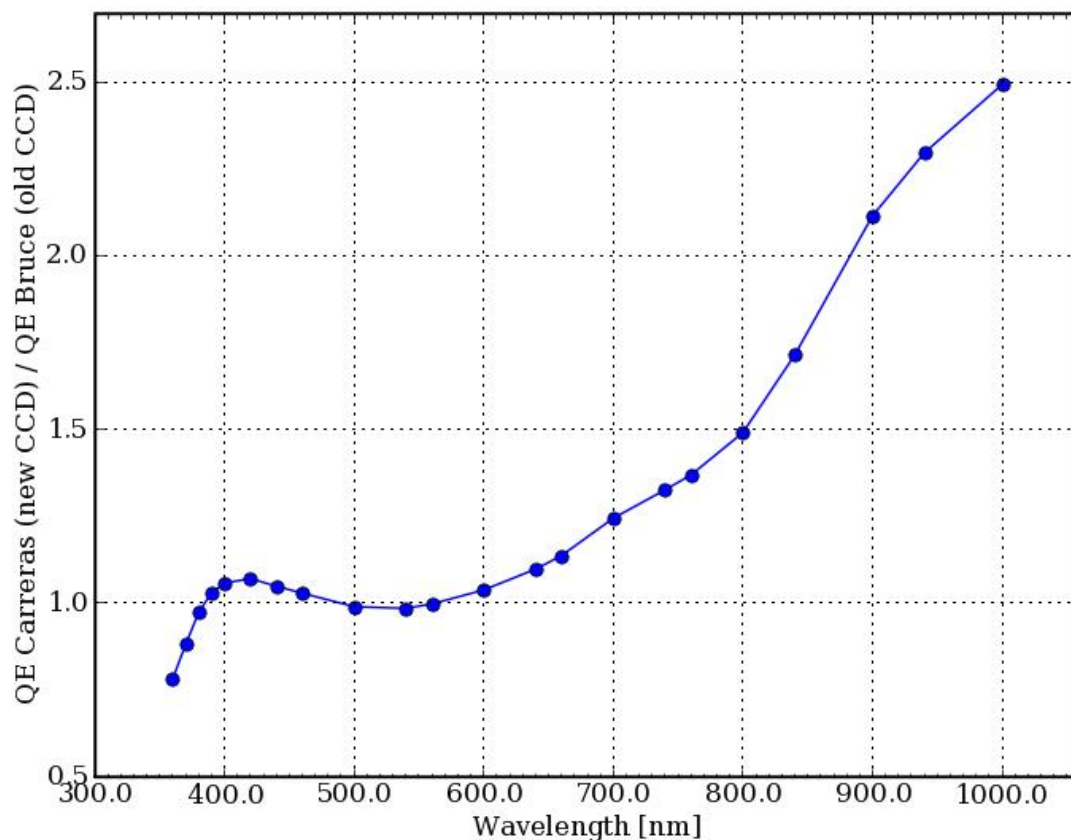

Figure 10: Quantum Efficiency ratio between Carreras and Bruce. This curve is based on lab. measurements made at ESO-Garching.

The high dispersion grating is a protected silver coated 200×400 mm 63.6 degree echelle (R2) with a high groove density (316 lines/mm), which ensures large orders also in the blue. The grating can turn on a turntable turret with very high accuracy (0.05 pixel) and repeatability (0.05 pixel rms). The whole (370 – 950 nm) spectral range is covered by twenty-four setups in 10 grating orders.

The original HR grating was replaced in October 2003 which has lead to an average efficiency gain of 46 per cent and loss of resolution of 15 per cent.

The low resolution grating has 600 lines/mm and a blaze of 34 degrees. The whole spectral range is covered with eight setups in 4 orders. The grating size is 150×200 mm, which implies that some vignetting (8 %) is present due to the geometry of the beam (180 mm). In the future, the aim is to provide a grating with the same characteristics but a larger size. The transmission curve of the low resolution grating is also given in the Appendix.

After being dispersed, the light passes again through the collimator, forms a real image at an intermediate focal plane and is finally imaged by a rather complex F/2 fully dioptric camera. The camera has seven elements, is thermally compensated for focus displacement through a system of thermally compensating bars that move one lens inside the camera. Note, however, that the collimator changes cannot be compensated with this system and that these are instead compensated through the slit focus movement.

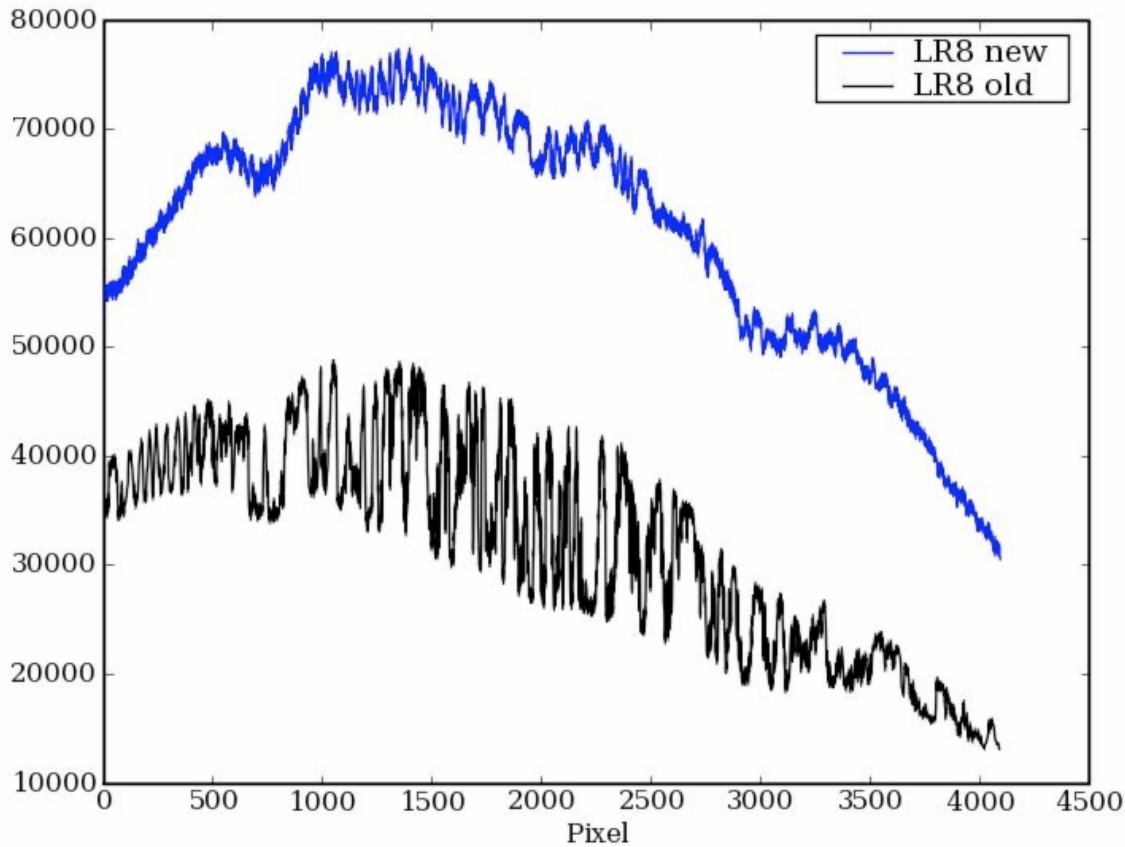

Figure 11: Extracted flat fields for the LR08 setup (centered at 881.7 nm). We compare the new chip (Carreras, blue curve) and the old one (Bruce, black curve). The two data sets were obtained with the same exposure times and with the same flat-field lamp. The fringing is strongly reduced on the new chip (6 times smaller). The higher efficiency of Carreras is also well visible (a factor of about 2 at this wavelength).

3.5.4 GIRAFFE scientific CCD “Carreras”

At the end of P80, the old blue-optimized GIRAFFE CCD (“Bruce”) was replaced by a thicker red-optimized chip: “Carreras”. The quantum efficiency of this new chip is significantly higher for wavelengths larger than 700 nm (e.g. a gain of factor of 2 at 880 nm). Between 400 and 700 nm, the quantum efficiency essentially remains the same as before. In the extreme blue ($\ll 400$ nm), a quantum efficiency loss up to 25% was measured in the lab but could not be confirmed on sky yet. Figure 10 shows the quantum efficiency ratio between Carreras and Bruce.

Thanks to the thickness of this new CCD ($40\mu\text{m}$), fringing is strongly reduced (6 times smaller peak-to-valley amplitude at 880 nm, see Fig. 11). The overall geometry of the Carreras (number of pixels in and X and Y directions, over/prescan regions) is the same as Bruce’s.

Carreras is equipped with a continuous flow cryostat, which provides a high mechanical stability. The liquid nitrogen tank is exchanged every ~ 14 days and a seal between the CCD and the enclosure ensures the thermal insulation of the spectrograph.

Table 8: Measured properties of the GIRAFFE scientific CCD “Carreras”.

Quantum efficiency	56% @ 350 nm 98% @ 400 nm 87% @ 500 nm 86% @ 600 nm 90% @ 700 nm 81% @ 800 nm 54% @ 900 nm
Thickness	40 μm
Number of pixels	2048 \times 4096
Pixel size	15 μm
Gain (low)	2.35e ⁻ /ADU
Readout noise	4.3 e ⁻ rms
Saturation (low gain)	~ 60 000 ADU
Full frame readout (225 kPix/sec)	43 sec
Dark current levels (-120°C)	1 e ⁻ /Pix/h
Cosmic hit event rate	3.14 \pm 0.18 event/min/cm ²
Non-linearity	< \pm 0.5%
Fringing amplitude (880 nm)	up to 5%
CTE	> 0.99999
Readout direction	in disp. direction.
Prescan, Overscan areas	Pix. 1–50 and 2098–2148
Fast readout mode in VM only	Since P86
Gain (low)	2.35e ⁻ /ADU
Readout noise	5.0 e ⁻ rms
Saturation (low gain)	~ 60 000 ADU
Full frame readout (625 kPix/sec)	15 sec
Slow readout mode in VM only	Since P97
Gain (high)	0.70e ⁻ /ADU
Readout noise	2.2 e ⁻ rms
Saturation (high gain)	~ 60 000 ADU
Full frame readout (50 kPix/sec)	180 sec

Carreras is controlled by a FIERA controller. We have opted not to offer any possibility of changing the windowing or binning. However, three readout speeds have been offered, the slow (50kHz) and the fast mode (625-KHz) are available only in visitor mode. Note that on-chip binning would undersample some regions of the spectra also in MEDUSA mode.

A compromise has been adopted for the read-out speed: the chosen setup works at a read speed of 225 kPixel/sec, which implies a reading time of 43 seconds, and excellent read-out noise (4.3 e⁻/Pixel at 225 kPix/sec reading speed and low gain). This mode is the one only offered in service mode and should remain the norm in visitor mode. However, a fast-readout mode is offered in visitor mode only with a read speed of 625 kPixel/sec, which implies a reading time of about 15 seconds, and a read-out noise of 5 e⁻/Pixel. The binning remains the same 1x1, and the gain is low. In addition, a slow-readout mode is offered in visitor mode only with a read speed of 50 kPixel/sec, which implies a reading time of about 180 seconds, and a read-out noise of 2.2 e⁻/Pixel (high gain; 1x1 binning). The CCD working temperature is -120°C, to minimize some of the blemishes, and to ensure negligible dark current (1 e⁻/Pixel/hour).

The cosmetic quality of Carreras is excellent. The electronic glow that was well visible on the top right corner of Bruce images has disappeared. No bad columns/rows are present and only one hot pixel (affecting some of its neighbours) was detected.

A summary of the GIRAFFE “Carreras” CCD characteristics for the readout mode 225kHz,1×1,low (which is the only one offered in service mode) is given in Table 8-top and for the fast and slow readout modes (625kHz,1×1,low and 50kHz,1x1,high, respectively) in Table 8-bottom.

3.5.5 Spectral Format and Efficiency

In GIRAFFE the spectra are parallel in dispersion along the long side of the detector (i.e., in readout direction), while on the short side is parallel to the slit. Spectra are curved, with the central part closer to each other than the edges. The lines of constant wavelength describe arcs of low curvature with respect to the CCD pixels. This implies that the wavelength coverage is slightly shifted (by a few Ångstroms) between the fibres at the edge and the fibres at the center of the slit (which are shifted to the red). An example of a Th-Ar wavelength calibration spectrum is given in Figure 12, blue is towards the left.

The setups have been fixed to guarantee instrument operability. By turning the grating, different combinations can be obtained for a given central wavelength and grating. The resolving power and coverage are both function of the grating angle.

For both gratings the spectral orders are quite long with respect to the detector. In order to guarantee the whole coverage, the grating(s) need to be rotated, which causes the differences in resolution and spectral coverage between the different setups. A higher angle corresponds to a higher resolution and to a smaller wavelength coverage. The setups have also been selected to give a 10% overlap between consecutive setups. This enables an easy connection between the different spectral slices of the same object.

The higher resolving power of the IFU and ARGUS modes (compared to the MEDUSA mode) is solely due to the smaller size of the fibres, which projects to 2.4 – 2.6 pixels instead of 3.8 – 4.2 pixels of MEDUSA. The spectral coverage for a given setup is the same in the MEDUSA, IFU and ARGUS modes.

For a given spectral format, the spectral resolution is very uniform along the chip. Measure-

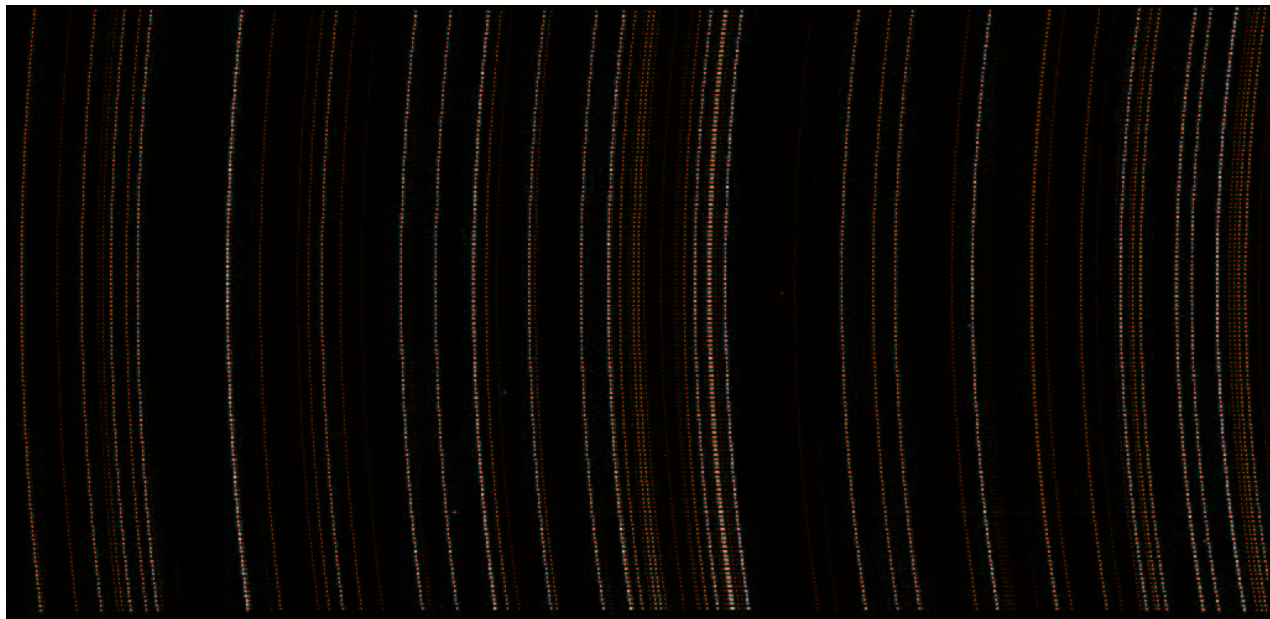

Figure 12: GIRAFFE CCD image of a Th-Ar calibration lamp. The fibres in the center of the slit have lines moved towards the blue (left), i.e., fibres corresponding to the center of the CCD will have a slightly redder wavelength coverage than the ones at the CCD edges.

ments show a variation of the resolving power along the chip of less than 4% rms.

It is important to recall that the efficiency can change substantially within the same setup, by almost a factor two if the wavelength of interest is close edge of the order. The ETC gives a very reasonable representation of the final spectral format.

3.5.6 GIRAFFE Setup Stability and Repeatability

GIRAFFE was built to be mechanically very stable; the slit exchange mechanics were designed to ensure high setup repeatability; the basic requirement being that the calibrations made during the day would well reproduce the night observations. This has been achieved, as confirmed from tests in Garching and Paranal. The flexures due to temperature variations measured in GIRAFFE in long term tests amount to ~ 0.4 pixels/K along and perpendicular to dispersion, which translates into typical shifts of ~ 0.2 pixel in the 12 hours night/day interval on the detector. The number given above includes the repeatability of the setup, since the tests were done by swapping setups between the tests. Note that GIRAFFE has no thermal compensation in the axis perpendicular to the dispersion, so that occasional large changes in the temperature can cause bigger shifts than those noted above. In these cases the calibrations need to be repeated as the extraction of fibre data are very sensitive to such shifts between science and calibration frames.

3.5.7 GIRAFFE Calibration Units

In addition to the calibrations performed through the Positioner calibration Unit (illuminating all the fibres sequentially, cf. § 3.3), GIRAFFE is equipped with two calibration units:

Simultaneous Calibration Unit (SCU)

In order to limit the use of time-consuming night calibrations, in each GIRAFFE mode 5 fibres are devoted to the acquisition of simultaneous Th-Ar spectra illuminated by the SCU during the science integration. The unit is equipped with a tunable neutral density filter which allows good Th-Ar exposure levels for integration times between 2 and 120 minutes. If not deselected in the observing template, these 5 SCU spectra are acquired automatically. Note that for faint objects the SimCal spectra can contaminate neighbouring spectra, especially for settings redward of 650-nm (see Sect. 3.8.2). Users can choose to take a 60-s exposure with the lamp ON, then the (long integration) science target with it OFF, then a 60-s exposure with it ON again, in order to eliminate the possibility of contamination.

Longslit Calibration Unit

One of the GIRAFFE slits is equipped with a longslit unit, fed by a calibration system with an integrating sphere. The slit is illuminated by an F/5 beam to simulate the F/5 fibre exit. This slit unit is mainly used for engineering tests and is equipped with one FF, one Ne and one Th-Ar lamp.

3.6 UVES – FIBRE mode

In fibre mode, part of the pre-slit area of UVES (see UVES Manual) is substituted by a fibre projector, which transforms the fibre focal aperture F/3 at the fibre exit into a 25 mm parallel beam.

In front of the fibre projector a shutter allows the light from the fibres to reach the mode selection mirror where the fibre mode is selected. After the light passes through a re-imaging F/10 lens, the regular red UVES slit and the UVES RED arm is used in fibre mode. UVES is exhaustively described in the UVES User Manual; only a very short description is given here (see <http://www.eso.org/sci/facilities/paranal/instruments/uves>).

The UVES RED arm ($\lambda\lambda$ 420–1100 nm) is a white-pupil type design. With a beam of 200 mm, the off-axis parabolic collimator illuminates the echelle grating of $214 \times 840 \times 125$ mm with a large blaze angle (76°). The echelle is used in quasi-Littrow mode, i.e., the angle of incidence and the angle of diffraction are equal but in a different plane, which maximizes efficiency.

The grating cross-dispersers provide an order separation larger than 10 arcsec at any wavelength in the spectral range 420 – 1100 nm. This separation allows to host the 8 UVES fibres (for the 580-nm and 860-nm settings), which have an aperture of 1 arcsecond each and are separated by 1.47 arcseconds.

The red camera is dioptric (no central obstruction) and provides an external focal plane for easy detector interfacing and upgrading during the lifetime of the instrument, together with a large field, good image quality and high optical transmission.

In the red arm, a mosaic of two 4096×2048 pixels CCDs is offered, separated by about 1 mm (loss of one order in the gap). The direction of the spectral dispersion (= echelle orders) is along the larger dimension of the CCDs. The instrument spectral formats (wavelength coverage, etc.) are always computed for these fixed CCD window settings.

The **Arm Selector** unit has four positions: Free (direct feed to the red arm), Mirror#1 to feed the blue arm, Dichroic#1 and Dichroic#2 to feed both arms. In fibre mode, the backside of Mirror#1 is used to feed the red arm of UVES with the light from the eight FLAMES fibres. The working position of this unit is determined automatically by the instrument software once

Table 9: UVES echelle and cross-disperser gratings

Echelle gratings					
	g/mm	Resolving Power	Spatial resolution	Blaze angle [°]	Blaze Eff. [%]
RED	31.6	2.100.000	0.09"	75.04	63
Cross-disperser gratings					
	g/mm	Wav. range [nm]	Average Eff. [%]	Wav of Peak Eff. [nm]	Blaze Eff. [%]
CD#3	600	420 – 680	> 60	520	68
CD#4	312	660 – 1100	> 70	770	80

the instrument observing mode is selected.

3.6.1 The RED Spectrograph Arm

The red **mirror collimator** consists of two off-axis parabolas and two flat mirrors. It is of the “white pupil” type with two 200 mm pupils: one for the echelle and one at the cross-disperser/camera which results in a moderate size of the optical components and a simplified design.

The red **echelle grating** is 840 mm long and 210 cm wide. Because grating masters of this size cannot be ruled, a new process was developed in which a replica is made of two precisely aligned masters. The result is called a “monolithic mosaic” and has a resolving power on the order of 2 000 000 and a stable Line Spread Function. The groove density and hence the order length was selected such that the order length at 990 nm is equal to the CCD length. Further information on the echelle (and cross-disperser) gratings can be found in Table 9.

The **cross-disperser unit** is a grating turret with two gratings mounted back-to-back. Selection of the grating is done by rotation of the unit; the angle of the grating is automatically set according to the required wavelength of the central echelle order. The properties of the red cross-disperser gratings #3 and #4 can be found in Table 9.

The **Camera** is dioptric with an external focus to facilitate detector exchange. Focus is set manually and then maintained automatically by thermal expansion rods in the camera support structure. The red camera has unvignetted entrance apertures of 230 mm, focal length of 500 mm, and fields of 87 mm diameter. Its image quality is 20 μm on-axis to 30 μm in the corners (diameter of circle containing 80% of the energy). The transmission curves can be found in the UVES database available through the instrument ETC.

Table 10: Measured properties of UVES-RED scientific CCDs "Sting" (EEV) and "Zeus" (MIT). Zeus is the replacement for the old MIT CCD, "Nigel" and has higher QE above ~ 700 -nm and reduced fringing. See Figs. 13 and 14.

	EEV	MIT/LL
Quantum efficiency	89% @ 450nm 89% @ 600 nm	84% @ 800 nm 64% @ 900 nm
Number of pixels	2048 × 4096	2048 × 4096
Pixel size	15 μm	15 μm
Gain (low)	1.47e ⁻ /ADU	low: 1.41e ⁻ /ADU
Readout noise	3.4 e ⁻ rms	3.7 e ⁻ rms
Saturation (low gain)	~ 65000 ADU	~ 65000 ADU
Full frame readout (225 kPix/sec)	30 sec	30 sec
Dark current levels (-120°C)	0.5 e ⁻ /Pix/h	1.5 e ⁻ /Pix/h
Fringing amplitude (850 nm)	up to 40%	up to 10%
CTE	> 0.99995	> 0.99995
Readout direction	in disp. dir.	in disp. dir.
Prescan, Overscan areas	Pix. 1–50 and 2098–2148	Pix. 40–50, 2098–3008
Flatness	< 30 μm peak-to-peak	< 60 μm peak-to-peak

3.6.2 Scientific CCD Mosaic "STING" + "ZEUS"

In early July 2009 the MIT UVES red CCD "Nigel" was replaced by another MIT "Zeus". Figure 13 shows the Quantum Efficiency ratio of Zeus to Nigel plotted as a function of wavelength, both from measurements in the lab and also from preliminary standard star observations. From ~ 500 -700-nm the QE of both CCDs is the same to within ~ 5 per cent. Redder than this the QE of Zeus relative to Nigel rises rapidly, being a factor of ~ 2 at 900-nm. The saturation level of the replacement CCD is now $\sim 65,000$ compared to some $\sim 40,000$ with Nigel.

Because Zeus is a thicker CCD than Nigel the fringing is also much reduced (although the cosmic ray count rate increased). Fig. 14 shows part of a FLAMES-UVES extracted flatfield at 860-nm taken with both CCDs in which this reduced fringing is evident.

A summary of the properties of the **red arm scientific CCDs** is given in Tab 10. The detailed QE curves can be found in the UVES database available through the ETC. The detector in the red camera consists of a mosaic of one EEV (CCD 44-82) and one MIT-LL (CCID-20) 4k×2k CCD; this to optimize the detector response as a function of wavelength and to reduce fringing at far-red wavelengths. The gap between the two CCDs is ~ 0.96 mm. This gap and the non-perfect alignment of the two chips require a separate extraction of the spectra of the two chips. The CCD control system (the ESO standard system FIERA) reads the mosaic as a single image with 100 artificial pixels between the two sensitive areas. The file has to be split before applying a standard echelle reduction package. **Windowing of the CCDs is not allowed, neither is CCD binning in UVES – FIBRE mode. Only ONE read**

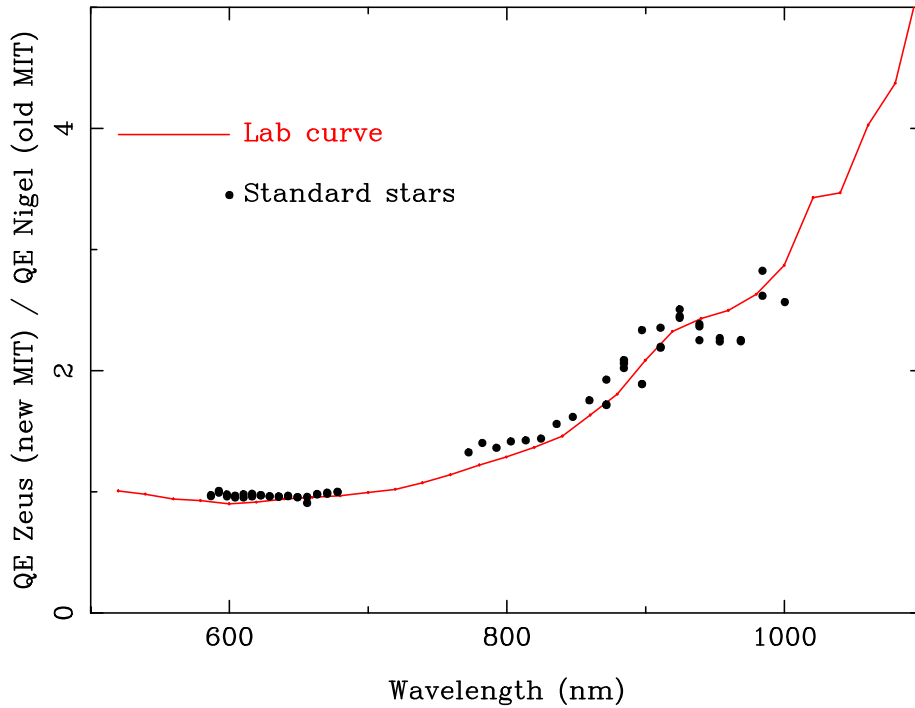

Figure 13: The ratio of the Quantum Efficiency of Zeus (new MIT CCD) / Nigel (Old MIT CCD). The curve is based upon both measurements in the lab and also standard star measurements. A factor ~ 2 increase in response at ~ 900 -nm is apparent.

out mode of the CCDs is offered in service mode: Low gain, slow read-out (225 kpix/sec), 1x1 binning. A slow (50 kpix/sec) and a fast readout mode (625 kpix/sec) are also offered in visitor mode.

The characteristics of these modes are given in Table 10. The linearity of the CCDs is measured to be better than 1% over the range from $\sim 200 e^-$ to the saturation limit in 1x1 binning. The CCD parameters are periodically re-measured at the observatory. The updated values are entered in the instrument database and are recorded in the FITS headers, for later use in the data reduction. The cosmetic quality of the scientific CCDs is very good.

The CCD cryostat is attached to the dioptric camera, with the last optical element acting as the dewar entrance window. The CCDs are operated at a temperature of ~ 153 K. A liquid-nitrogen tank ensures continuous operation without manual intervention for ~ 2 weeks. The **shutter** is located between the cryostat window and the camera. It is actuated by solenoids with an open/close time of 50 ms. The illumination of the detectors is homogeneous within 50 ms but a **minimum exposure time of 0.5 sec** is recommended. The reader is referred to the CCD webpages of the ESO Optical Detector Team for additional general information on the CCDs and the FIERA CCD Control System (<http://www.eso.org/odt/>).

3.6.3 Spectral Resolution and Overall Efficiency

In contrast to slit mode (standalone UVES), in fibre mode (FLAMES-UVES) the user cannot set the resolving power by choosing the slit width, and the resolving power is determined by the projection of the fibre apertures on the CCD. The only variable factors which may affect the

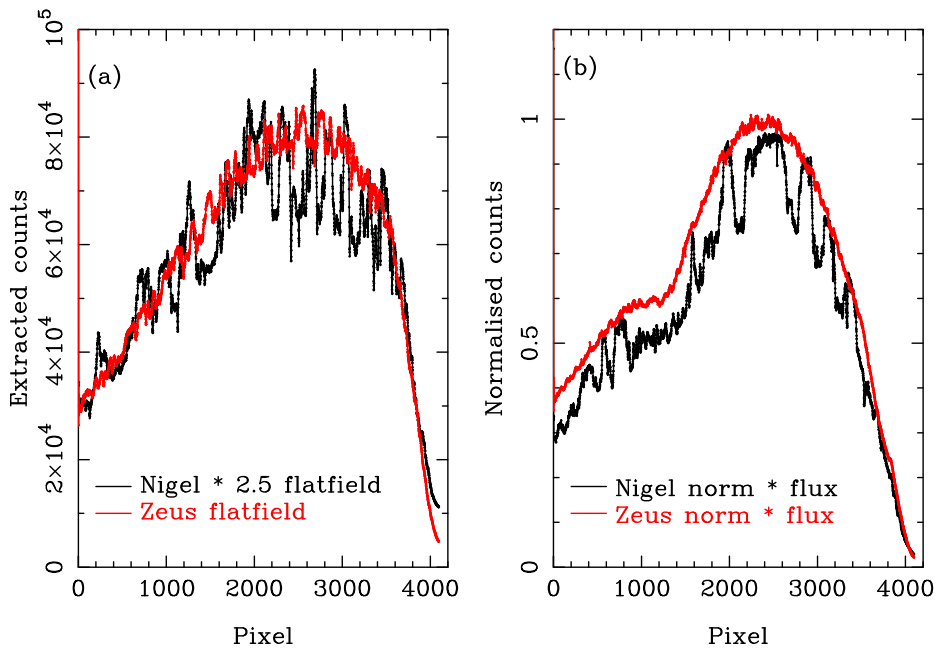

Figure 14: (a) Extraction of a single order FLAMES-UVES flatfield for Zeus (new CCD: red line) and Nigel (old CCD: black line) with the counts multiplied by 2.5 (the integration times were the same). Much reduced fringing is obvious. (b) Extraction of a single order of the same fast rotating star with Zeus (red) and Nigel (black). Again, the fringing in Zeus is much reduced.

resolving power are the image quality of the optics (including the focus and the alignment), CCD effects (chip tilt, diffusion of photoelectrons, charge transfer), as well as the echelle dispersion. The instrument does not include a remotely controlled focus adjustment, since the cameras automatically compensate for temperature variations of the complete optical train from slit to CCD. The image quality over the entire spectral range is better than $20 - 30 \mu\text{m}$ over the full CCD (80% of the energy). This implies that, in practice, no noticeable variations are expected between different exposures. The measured resolving power in Fibre mode is $R \approx 47000$.

The efficiency of the RED arm of UVES in fibre mode is about 40% lower than UVES in slit mode for observations of a single point source.

It is rather difficult, however, to accurately predict the real differences in flux collection between the two modes, because they will be function of the seeing and of how accurate fibre centering has been performed.

3.7 FLAMES Features and Problems

This section lists some of the features and problems common to FLAMES. Several of these topics are very important for efficient observations with FLAMES.

3.7.1 Maximum reachable S/N ratio

Fibre systems, when coupled to spectrographs, suffer from small photometric instabilities, whose relevance depends on many factors, including the fibre type, the fibre system design, the spectrograph design, basically the full path from fibre entrance to detector.

This instability shows up as time variable fringing, additional to the fringing produced by the CCD. This usually induces limitations in the maximum attainable S/N ratio; the measured vs. expected S/N ratios depart more and more and the measured S/N ratio tends to a maximum asymptotic value. For FLAMES, S/N ratios have been obtained in a single exposure up to S/N of 400. The departure from the photon noise in this regime was very high. We consider this value as the limiting single exposure S/N value.

3.7.2 Enhanced Dark Current after a FIERA Start-up

When the CCD Control System FIERA has to be restarted, e.g. due to a unrecoverable error or a general failure of the CCD, the level of the dark current will be higher than the value measured in the running system; approximately an extra 5 ADU in an hour-long GIRAFFE exposure following the shutdown and an extra 0.5 ADU RMS noise. It is important to check the performance of the detectors by taking e.g. a dark exposures of a few minutes in binned mode. An interval of 2–3 hours is normally sufficient to return to optimal performance of the CCD.

3.8 GIRAFFE Features and Problems

3.8.1 Low counts in blue attached screen flatfields

It is almost impossible to get sufficient flux with a reasonable exposure time for the bluest setups for attached screen flats. In the bluest three HR settings there are typically only a few hundred ADU detected in a 20-minute exposure time in the bluest part of the CCD. Hence accurate flatfielding for the HR1, HR2, HR3 and LR1 settings for **ARGUS ONLY** is not presently possible within service mode normal programmes. These four settings are therefore only offered in visitor mode in Argus to allow for more time to take the attached flatfields in the daytime. Even then the number of derived counts obtained at the far blue end may only be around a thousand in a few hours. Note that for Medusa and IFU settings the robot (not screen) flats are adequate in the blue so all settings are offered in service mode for these fibre systems.

3.8.2 Contamination from Simultaneous Th-Ar Calibrations

Although GIRAFFE has very low level of scattered light, the 5 simultaneous fibres, in particular in the reddest setups may show very strong Argon lines. These lines cannot be suppressed by any filter, and give visible ghosts (at the level of several ADUs) over a large part of the CCD area. It appears as a diffuse increase in the background (10 – 20 electrons), with an increase up to 40 – 60 electrons (numbers are indicative) very close to the strong lines. These ghosts may be very bad for those users interested in faint objects low S/N ratio observations, since they increase substantially the background. Since the spectrograph is quite stable, users who are

observing faint objects and who are not interested in accurate radial velocity determinations should switch the simultaneous calibration OFF. This can be done by filling in the appropriate field in the FLAMES observing templates. For Medusa mode, the retractor positions of fibres adjacent to the simultaneous calibrations are as follows; Medusa plate 1; retractor positions 24, 44, 84, 104, 144, 164, 194, 224, 264. Medusa plate 2; retractor positions 24, 44, 84, 106, 130, 170, 204, 224, 264.

3.8.3 In-focus Ghosts and Scattered Light

A 3% scattered light level is observed in the reddest 300 pixels of the spectrum; the feature is rather sharp and most likely caused by a white light ghost, i.e., a reflection inside the collimator; it affects all the 2048 pixels along the slit direction.

3.8.4 CCD Defects

- **The old detector: “Bruce” (until P80)**

The EEV chip “Bruce” has very few cosmetic defects. The most noticeable is a hot column, which affect all the pixels of row 420 redder than pixel 1270. This column does not affect the same spectrum in all setups, due to slight shifts between the different setups. The most affected spectra are spectrum number 24 in MEDUSA mode, which corresponds to button 58, but a movement of ± 1 spectrum depending on the chosen setup and on the long term spectrograph spectrograph stability, is possible. Other defects can be generally eliminated by flat fielding.

In the upper red corner (i.e, at fibres with high button numbers) a rectangle of about 350×200 pixels shows a higher level of counts in long exposures (up to about 60 electrons in one hour). This feature is generally referred as “the glow”.

- **The new detector: “Carreras” (after P80)**

The EEV chip “Carreras” has very clean cosmetics. It has no known bad column or row. The number of dark pixels (i.e. pixels with flux values less than 50% of the local mean) is 62. There is only one hot pixel located at [185;3040]. This hot pixel affects the counts recorded for some of its neighbours. The exact number of affected surrounding pixels depends on the CCD temperature (typically about 10 pixels at the operating temperature).

3.9 UVES Features and Problems

We note that in early July 2009 the RED MIT CCD of UVES (Nigel) was replaced by Zeus that has a higher throughput redwards of 700-nm and less fringing. See Sect. 3.6.2. s

3.9.1 UVES SimCal lamp too bright for long exposures

When observing with the FLAMES-UVES (7+1) setting, the strength of the simultaneous ThAr calibration lamp is set for an exposure time of 15 minutes. Unlike the SimCal lamp in GIRAFFE, there is no filter available in UVES to reduce the flux for long exposures. This leads to saturation in some lines in long integration times.

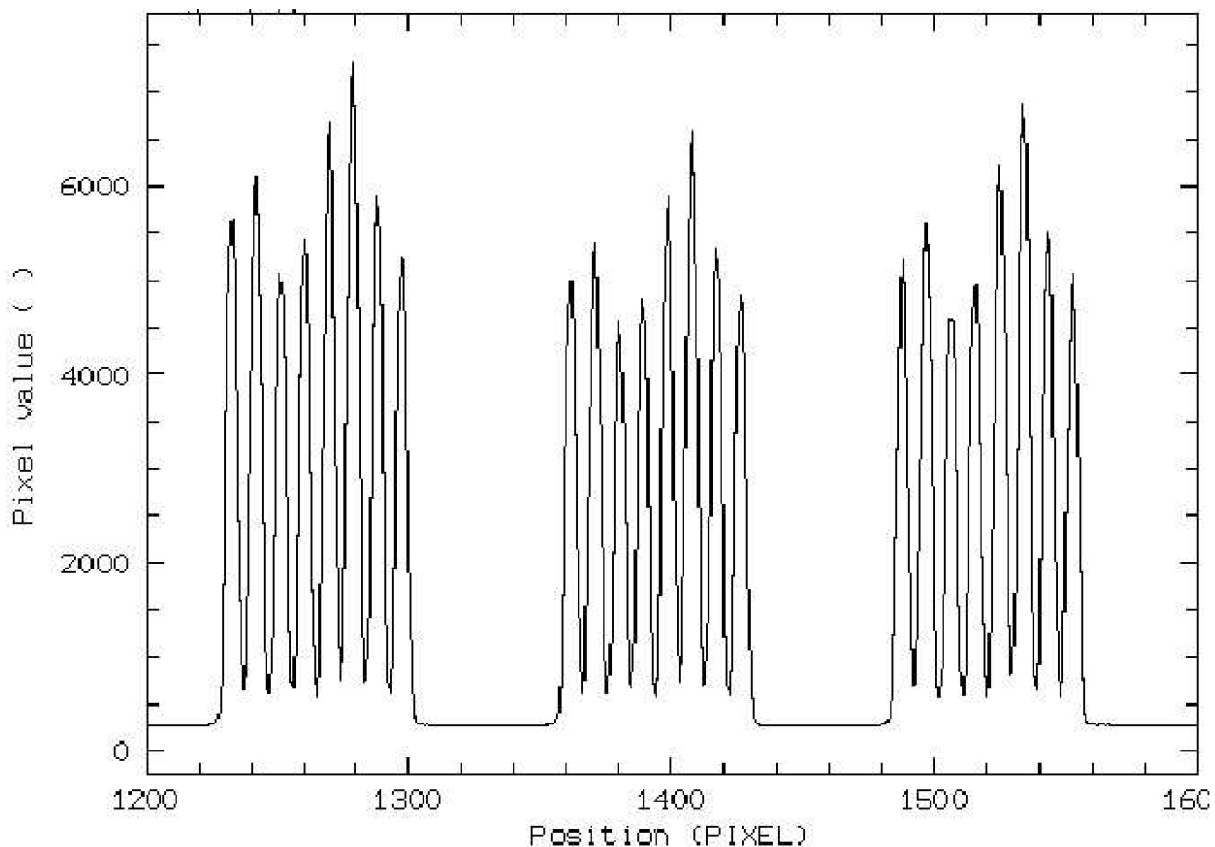

Figure 15: This figure shows a trace perpendicular to the dispersion of an UVES-FIBRE frame, containing three orders. Note the flux overlap between contiguous fibres. the UVES-Fibre data reduction software is designed to deblend the contributions

3.9.2 Fibre Overlap in the 520 nm Setup

Below 500 nm, the order separation becomes too small to accommodate all 8 UVES fibres without overlap. Therefore, the decker of the UVES slit masks the UVES fibres #8 and #9 (corresponding to buttons 103 and 235, respectively) if the 520 nm setting is selected. If these two fibres have been assigned to targets, the light will be lost. Hence only 6 fibres are available in the 520-nm setting.

3.9.3 Fibre-to-fibre Contamination

Given the limited separation between the UVES fibres, a small degree of contamination exists between one fibre and its neighbour on the slit. This can be seen easily in Figure 15 showing a trace of three UVES orders in direction perpendicular to the dispersion: three groups of 8 fibres are seen and the reader can notice that the flux level in the interfibre is higher than the interorder light and that the flux at the base of one fibre is slightly overlapping with the neighbouring one.

The contamination can be divided into two main components:

1. Diffuse light: this light depends primarily on the total amount of light injected in the spectrograph; it follows the echelle intensity curve and is estimated at the level of 0.2%

/pixel of the adjacent fibre overall intensity. This implies that if 8 stars of similar intensity are observed, their overall contribution to diffuse light will be at the 1% level of a single source; however diffuse light has no spectral features, and it appears as a 'continuous' source.

2. Fibre-to-fibre direct contamination: the wings of two adjacent fibres slightly overlap and this gives a direct contamination (including spectral features) of one fibre to the next. This value is however very low, and it increases from 0.13% to 0.5% going from an integration over 5 to 7 pixels. One fibre has a PSF FWHM of 4.5 pixels (Gaussian PSF approximation), but note that the PSF is not Gaussian.

This implies that some care should be taken in not placing objects with large differences in magnitudes and possibly of very different nature (e.g., emission and absorption line objects), in adjacent positions on the detector. Note that the UVES-Fibre Data Reduction Software (DRS) has been developed to take into account and eliminate this fibre-to-fibre contamination.

3.9.4 Spectral Gaps in the RED

The CCD detector in the red arm (see Section 2.4) consists of a mosaic of two chips, separated by a gap of approximately 0.96 mm. This results in the loss of one echelle order in the recorded spectrum around the central wavelength selected by the observer. At 580 nm the gap spans around 5 nm and at 860 nm the gap is 10 nm. The dimension of the gap at any central wavelength can be predicted with high accuracy (≤ 0.5 nm) using the instrument ETC.

3.9.5 Optical Ghosts in the far red Spectra

Spectra imaged on the CCD mosaic in the red arm are partly reflected back to the cross-disperser grating through the camera lenses. After a further reflection on the grating, the second order spectrum is re-imaged by the camera on the CCDs. These "ghosts" appear as in-focus echelle orders, with a steeper inclination and approximately twice the order separation than the primary spectra. The effect is relevant with the cross-disperser #4 at the far end of the spectrum (central wavelength 860 nm) where the efficiency of the CCD decreases and the importance of reflections is higher. On the MIT chip (upper CCD in the mosaic), reflections from the EEV (lower CCD of the mosaic) are seen. For reference, see the flat-field data available on the UVES web page. The relative intensity of the ghosts to the primary echelle orders depends on the shape of the target spectrum. With flat fields and at a central wavelength of 860 nm, the intensity of the ghost orders is $< 1\%$ of the real orders on the EEV chip and between 1 and 7% on the MIT chip.

3.9.6 CCD Cosmetic Defects

The CCDs of UVES are of excellent cosmetic quality. The number of hot or less sensitive pixels is limited ($< 0.1\%$) and has little effect on the quality of the data because of the good sampling.

The defects which, depending on the signal-to-noise of the spectrum, might be visible in the extracted data are listed below. In the EEV CCD (blue side of the CCD mosaic) there are four

trails of hot pixels which appear in long exposures (X coordinates 3896, 3963, 4052 and 4140 in an unbinned FITS file, middle of the chip in y). They each affect a single column (longer dimension of the CCD) and are almost parallel to the echelle orders. They would appear as broadish emission lines in the bluer part of the extracted spectrum of a faint object.

Nigel (Old MIT CCD)

In the MIT-LL chip (red side of the CCD mosaic), there is a trap in the column $X = 1609$ which might show up as a slight depression over ~ 130 pixels in the extracted spectrum of one order

Zeus (New MIT CCD)

In the MIT-LL chip (red side of the CCD mosaic), there is a bad column at 1254 weakly visible in the bias images.

4 Preparing the Observations

4.1 Introduction

Before the actual execution of observations, several steps have to be taken. The preparation of an observing programme is split in two parts: Phase I and Phase II. In Phase I, i.e., the application for VLT observing time, the emphasis is put on the scientific justification and on the technical feasibility of the proposed observations. **For the specific case of FLAMES, the proponents must clearly show that they have (or will have) the proper target list (including astrometry) prior to Phase II.** In Phase II the successful applicants have to prepare their detailed observing plan including the instrument setups using via the web based Phase II Preparation (P2) tool.

Prior to Phase II, however, it is fundamental that the applicants have prepared the proper files containing the target list and have already processed them with the FPOSS tool.

Together with the general Phase I (<http://www.eso.org/sci/observing/phase1.html>) and Phase II (<http://www.eso.org/sci/observing/phase2.html>) documentation, the information contained in this chapter (and in Chapter 5) provides guidelines for the Phase I and Phase II preparation process for FLAMES observations. In Chapter 6 information is given for astronomers who come to Paranal to observe with FLAMES.

The preparation process can be summarized as follows:

Phase I

- Scientific justification
- Choice of instrument and mode
- Estimate of exposure time to reach the required S/N ratio at the desired resolution.
- Selection of the targets, check availability of accurate coordinates.
- Estimate of telescope and instrument overheads
- Determination of scheduling constraints (e.g. visibility, time-critical observations)
- Overview of observation plan (e.g., target list, calibration needs)

Phase II (*only for successful applicants*)

(**bold** represent tasks specific for FLAMES)

- **Preparation of the target input files**
- **Preparation of the positioner Target Setup Files with FPOSS.** Users should pay particular attention to the list of broken fibres (see below Sec. 4.6)
- Identification of detailed instrument setups
- Preparation of required Observation Blocks.

- Recalculation of exposure time if new version of ETC has been released.
- Preparation of a Finding Chart.

Due to its design and concept, FLAMES is an ideal instrument for observations in **service mode**, carried out by the observatory staff (i.e., in absence of the applicant).

All the information necessary to the execution of the observations has to be provided to ESO in the form of Observation Blocks prepared through the p2 web-based tool, following the instructions sent to the applicants. The Observatory staff will combine the execution of different programmes in the same night optimizing the time sequence, seeing, and moon requirements. Observations carried out with the applicant present at the telescope are referred to as **visitor mode** observations. In this mode the astronomer prepares (or finalizes) the OBs at the Observatory in advance of his/her nights. He/she decides about the sequence of observations during the night, but their execution is, however, still performed by the telescope and instrument operator.

FLAMES is fully supported by p2fc, the finding chart generator built into p2. Once the OB is complete, including the FPOSS setup file, simply click the "Generate Finding Charts" button in the "Finding Charts" tab of the p2 main window.

To facilitate the preparation of Phase I (and Phase II) proposals, in addition to the information provided in this User Manual, ESO has developed sophisticated Exposure Time Calculators (ETC), one for GIRAFFE and one for UVES-Fibre (see § 4.7.1). The ETC permits one to estimate the signal-to-noise ratio for a given configuration and exposure time (taking into account specific atmospheric conditions) and determines the spectral format resulting from the selected instrument setup.

The Phase 2 web interface, p2, is available at the following URL:

<https://www.eso.org/p2>

A brief description of the benefits and new features of p2 can be found here:

<https://www.eso.org/sci/observing/phase2/p2intro.html>

It is worthwhile recalling that for FLAMES the OB preparation is very simple, while most of the effort is required to provide objects, fiducial stars and VLT guide stars in the same astrometric coordinate system with a relative rms accuracy better than 0.3 arcsecs.

A UVES-fibre (since April 2003) and a GIRAFFE (from April 2004) data reduction pipeline runs at the observatory. They enable automatic extraction and wavelength calibration of most settings, in order to check of the quality of the observations (resolution, signal-to-noise ratio in the extracted spectra). The science data are calibrated with calibration exposures from a calibration database which is updated when required.

Note that at the time of writing there is **no sky subtraction** available in the GIRAFFE pipeline.

4.2 FLAMES Modes and basic Choices

After the detailed description of the GIRAFFE and UVES spectrographs, and their subsystems and functions (Chapter 3), we provide an overview of the different FLAMES observing modes.

FLAMES is equipped with two spectrographs, GIRAFFE and the RED arm of UVES. UVES can be either used with all 8 fibres acquiring source (or sky) photons, or by using seven fibres on sources and one fibre to record simultaneously a Th-Ar arc lamp spectrum (UVES7+1).

GIRAFFE can operate in either MEDUSA, IFU or ARGUS mode. Simultaneous observations with UVES can be carried out with any of the GIRAFFE modes. However, only *one* GIRAFFE mode can be used at a time (e.g., it is not possible to observe simultaneously with MEDUSA + IFU).

In summary, all the possible modes of FLAMES include:

1. UVES (8 fibres to targets in 580 or 860 nm setup, 1 arcsec diameter each)
2. UVES (6 fibres to targets in 520 nm setup, 1 arcsec diameter each)
3. UVES7+1 (7 fibres to targets + 1 simultaneous calibration fibre illuminated with a Th-Ar lamp, only in the 580 nm setup)
4. GIRAFFE–MEDUSA (131 fibres to targets, 1.2 arcsec diameter each + 5 simultaneous calibration fibres illuminated with a Th-Ar lamp)
5. GIRAFFE–IFU (15 movable rectangular Integral Field Units, 2×3 arcsec each, made of an array of 20 fibres + 15 sky fibre units)
6. GIRAFFE–ARGUS (Single, fixed Integral Field Unit, consisting of 14×22 microlenses, with scale of either 0.52 or 0.3 arcsec each)
7. Any combined simultaneous UVES (or UVES7+1) plus GIRAFFE mode (two *simultaneous* GIRAFFE modes are not possible!)

However, in order to insure a manageable calibration database, only a limited amount of setup combinations (such as CCD setting) are offered.

It is also important to note that in the COMBINED modes the guiding can be performed only at one given wavelength, even if the two spectrographs have different central wavelength settings. This could result in some efficiency losses for the cases when the UVES and GIRAFFE central wavelength are far apart and/or when the chromatic atmospheric effects of the atmosphere are relevant during the exposure (see § 4.4).

4.3 GIRAFFE and UVES Standard Settings

To facilitate the preparation of Observation Blocks (§ 4.7), **standard settings** have been defined that allow the observer to select a pre-defined instrument setting for which all parameters are fixed at optimal values and only the exposure time and number of observations are left to be decided. **The observers can only use these standard settings.** The automatic data processing pipelines are available for these standard settings only.

The FLAMES standard settings are given in Chapter 2, and repeated here for the sake of completeness:

4.3.1 GIRAFFE Standard Settings

GIRAFFE standard settings are given for the high and low resolution modes in Tables 11 and 12 respectively. Each setting has a unique FITS keyword INS.EXP.MODE, which is the same as the “p2 name” given in the tables. In these tables, in addition to the central wavelengths of the settings, their coverage and resolving power is given, as measured with Th-Ar lines. Since the coverage varies slightly from fibre to fibre (cf. § 3.5.5), the coverage given in the tables is the **coverage interval common to all fibres**.

Filt ¹	θ^2	Ord	p2/ETC	λ_{start}^3	λ_{cent}^3	λ_{end}^3	$\Delta\lambda$	$R_{\text{MED/(IFU\&ARG)}}^4$
1	61.1	15	H379.0 / HR01	370.0	379.0	386.7	16.7	26 750 / 43 350
2	58.2	14	H395.8 / HR02	385.4	395.8	404.9	19.5	22 700 / 34 800
3	63.0	14	H412.4 / HR03	403.3	412.4	420.1	16.8	31 400 / 48 750
4	59.1	13	H429.7 / HR04	418.8	429.7	439.2	20.5	24 000 / 35 550
5	55.1	12	H447.1A / HR05A	434.0	447.1	458.7	24.7	20 250 / 30 250
5	63.9	13	H447.1B / HR05B	437.6	447.1	455.2	17.6	33 000 / 50 530
6	59.1	12	H465.6 / HR06	453.8	465.6	475.9	22.2	24 300 / 35 150
7	54.5	11	H484.5A / HR07A	470.0	484.5	497.4	27.4	19 500 / 27 850
7	63.9	12	H484.5B / HR07B	474.2	484.5	493.2	19.0	33 500 / 51 150
8	58.5	11	H504.8 / HR08	491.7	504.8	516.3	24.6	23 500 / 37 000
9	53.3	10	H525.8A / HR09A	509.5	525.8	540.4	31.0	18 000 / 28 000
9	63.2	11	H525.8B / HR09B	514.3	525.8	535.6	21.3	31 750 / 50 500
10	57.3	10	H548.8 / HR10	533.9	548.8	561.9	28.0	21 500 / 33 700
11	62.0	10	H572.8 / HR11	559.7	572.8	584.0	24.3	29 500 / 46 500
12	55.6	9	H599.3 / HR12	582.1	599.3	614.6	32.5	20 250 / 32 000
13	60.3	9	H627.3 / HR13	612.0	627.3	640.5	28.5	26 400 / 42 200
14	52.6	8	H651.5A / HR14A	630.8	651.5	670.1	39.4	18 000 / 27 900
14	65.1	9	H651.5B / HR14B	638.3	651.5	662.6	24.3	36 900 / 58 350
15	–	8	H665.0 / HR15N	647	665.0	679	~32	~19 000 / ~30 000
15	56.4	8	H679.7 / HR15	660.7	679.7	696.5	35.9	21,350 / 35 500
16	61.1	8	H710.5 / HR16	693.7	710.5	725.0	31.3	27 400 / 45 500
17	51.7	7	H737.0A / HR17A	712.9	737.0	758.7	45.9	17 350 / 29 250
17	65.9	8	H737.0B / HR17B	722.5	737.0	749.0	26.5	38 100 / 65 100
18	55.4	7	H769.1 / HR18	746.8	769.1	788.9	42.0	20 150 / 32 350
19	46.9	6	H805.3A / HR19A	774.5	805.3	833.5	59.0	14 500 / 23 250
19	60.1	7	H805.3B / HR19B	785.6	805.3	822.5	36.9	26 500 / 43 700
20	49.6	6	H836.6A / HR20A	807.3	836.6	863.2	56.0	15 800 / 25 400
20	64.9	7	H836.6B / HR20B	819.5	836.6	850.9	31.4	34 900 / 57 100
21	53.2	6	H875.7 / HR21	848.4	875.7	900.1	51.7	18 000 / 28 000
22	43.7	5	H920.5A / HR22A	881.6	920.5	956.5	74.9	11 800 / 17 100
22	57.9	6	H920.5B / HR22B	896.0	920.5	941.9	45.9	23 550 / 34 200

Table 11: All 31 high resolution setups of GIRAFFE with 316 lines/mm and 63.5 blaze grating. These setups are valid for observations taken after October 10th 2003 when a new HR grating was installed. A comparison between the old and new HR gratings is given in Sect. 7.4. The “B” settings always have lower efficiency than the “A” settings. In particular, at λ_{cent} the efficiency ratios are approximately as follows; H447.1B / H447.1A=0.6, H484.5B / H484.5A=0.7, H525.8B / H525.8A=0.7, H651.5B/H651.5A=0.5, **H737.0B / H737.0A=0.3**, H805.3B/H805.3A=0.7, **H836.6B/H836.6A=0.25**, H920.5B / H920.5A=0.7. The H665.0 setting covers both H α and Li6707. Previous to P74, settings such as H447.1A, H484.5A etc were called H447.1, H484.5 without the ‘A’ suffix. The resolving powers are updated after the February 2015 intervention. Note that for ARGUS normal programmes that HR01, HR02 and HR03 are available in visitor mode only due to the difficulties of obtaining sufficient counts in the attached screen flatfields. For Medusa/IFU all settings are available in Service or Visitor Mode. 1=Filter number; 2=Exit angle; 3=Wavelengths at the edges and center of the CCD in nm; 4=Resolving power R for MEDUSA, IFU, ARGUS.

Table 12: All 8 low resolution setups of GIRAFFE with 600 lines/mm and 34.0 blaze grating. The resolving powers are updated after the February 2015 intervention. Note that for ARGUS normal programmes that LR01 is available in Visitor Mode only due to the difficulties of obtaining sufficient counts in the attached screen flatfields. For Medusa/IFU all settings are available in Service or Visitor Mode.

Fil. #	θ [$^{\circ}$]	Ord. #	p2/ETC name	λ_{start} [nm]	λ_{center} [nm]	λ_{end} [nm]	$\Delta\lambda$ [nm]	Resolving Power MED/(IFU&ARG)
1	32.4	5	L385.7 / LR01	362.0	385.7	408.1	46.1	7 500 / 12 000
2	27.9	4	L427.2 / LR02	396.4	427.2	456.7	60.3	6 000 / 8 500
3	32.2	4	L479.7 / LR03	450.1	479.7	507.8	57.8	7 500 / 10 150
4	26.3	3	L543.1 / LR04	501.5	543.1	583.1	81.6	5 750 / 8 500
5	30.6	3	L614.2 / LR05	574.1	614.2	652.4	78.3	6 750 / 10 500
6	34.9	3	L682.2 / LR06	643.8	682.2	718.4	74.6	8 500 / 13 500
7	24.7	2	L773.4 / LR07	710.2	773.4	834.3	124.0	5 500 / 8 200
8	29.0	2	L881.7 / LR08	820.6	881.7	940.0	119.0	6 500 / 10 000

4.3.2 UVES Standard Settings

UVES RED standard settings							
Mode	Cross Disp.	Below slit filter	Min. Wav.	Central Wav. [nm]	Max. Wav.	NMaxFib	Gap [nm]
RED	CD#3	SHP700	414	520	621	6	1
RED	CD#3	SHP700	476	580	684	8	5
RED	CD#4	OG590	660	860	1060	8	10

Table 13: The 3 UVES red standard settings are listed below. The two CCDs in the red camera are separated by approximately 0.96 mm; this results in a gap in the wavelength coverage, approximately centered on the central wavelength. The start and end points of the spectral ranges reported in the table are generally conservative as they do not include the echelle orders which are outside the sensitive area of the CCD by more than 50% of their length. No major changes to the UVES settings occurred after the upgrade of the UVES RED CCDs in July 2009 although there was a slight change in the angle between the two parts of the mosaic.

The standard settings for UVES are listed in Table 13. They are chosen such that together they cover the optical wavelength domain from 420 – 1100 nm. The wavelength coverage is computed for the 4k×4k CCD mosaic of the UVES RED arm. The below-slit filters are used to suppress the second order of the CD gratings or undesired light from entering the spectrograph. The wavelength coverage is incomplete above 993 nm, due to the absence of overlap between adjacent orders.

4.4 Differential Atmospheric Effects

An important problem that cannot be neglected when performing multi-object spectroscopy in a large field, is the differential refraction of the atmosphere. This is a *differential* effect in the sense that the atmospheric refraction index, and hence the direction of propagation of the light from a given star, changes with both zenith distance and wavelength.

The consequences for astronomical observations are therefore two-fold:

- An achromatic effect since the refraction index at a given wavelength changes – non-linearly – with the zenith distance. This is very important when observing large fields, because stars in different position within the field can have significantly different zenith distances, and therefore do not move in a coherent way across the sky, making it impossible to guide on the whole field.
- A chromatic effect because the refraction index changes with wavelength. As a result, the red and the blue part of the spectrum do not hit the fibre at the same position, and therefore part of the stellar spectrum can fall outside the fibre entrance. This effect is important only when observing over a wide spectral range, especially in the blue; it will therefore be more relevant for the GIRAFFE low resolution setups and for UVES.

The achromatic effect cannot be compensated, since it is differential across the field and strongly dependent on the actual zenith distance. It is therefore extremely important to be aware of its amplitude in different observing conditions, in order to correctly plan the observations.

A analytical formula that takes into account all the parameters affecting the amount of the differential atmospheric refraction has been given by Filippenko (1982, PASP 94, 715). According to his calculation, the refraction index, n , of the atmosphere at a certain wavelength, λ , is given by:

$$n(\lambda) - 1 = 10^{-6} \times \left[64.328 + \frac{29498.1}{146 - \lambda^{-2}} + \frac{255.4}{41 - \lambda^{-2}} \right] \times \left[\frac{P [1 + (1.049 - 0.0157T) \times 10^{-6}P]}{720.883(1 + 0.003661T)} \right]$$

where P is the atmospheric pressure in mm Hg (typically 557.25 for Paranal) and T is the temperature in °C (typically 11.5 for Paranal). Once the refraction index is properly determined, the displacement of the observed astronomical object with respect to its position “without” the atmosphere is

$$dr(\lambda) = n(\lambda) \tan(z),$$

where z is the zenith distance of the object.

The problem when observing a large field of view is that an object at the field corner will have a zenith distance z' different from that at the field center z , hence its observed position will be displaced with respect to the “real” one by a different quantity. The size of this difference is proportional to $\tan(z) - \tan(z')$ and therefore varies non-linearly with the zenith distance of the whole field. Since the telescope is guiding with respect to the center of the field, this effect causes distortions at the field edges, that change shape with time as the observed field moves across the sky.

Figure 16 illustrates the amplitude of this effect for an object located 9 arcmin away from the field center, as a function of the hour angle of the observations and the target declination.

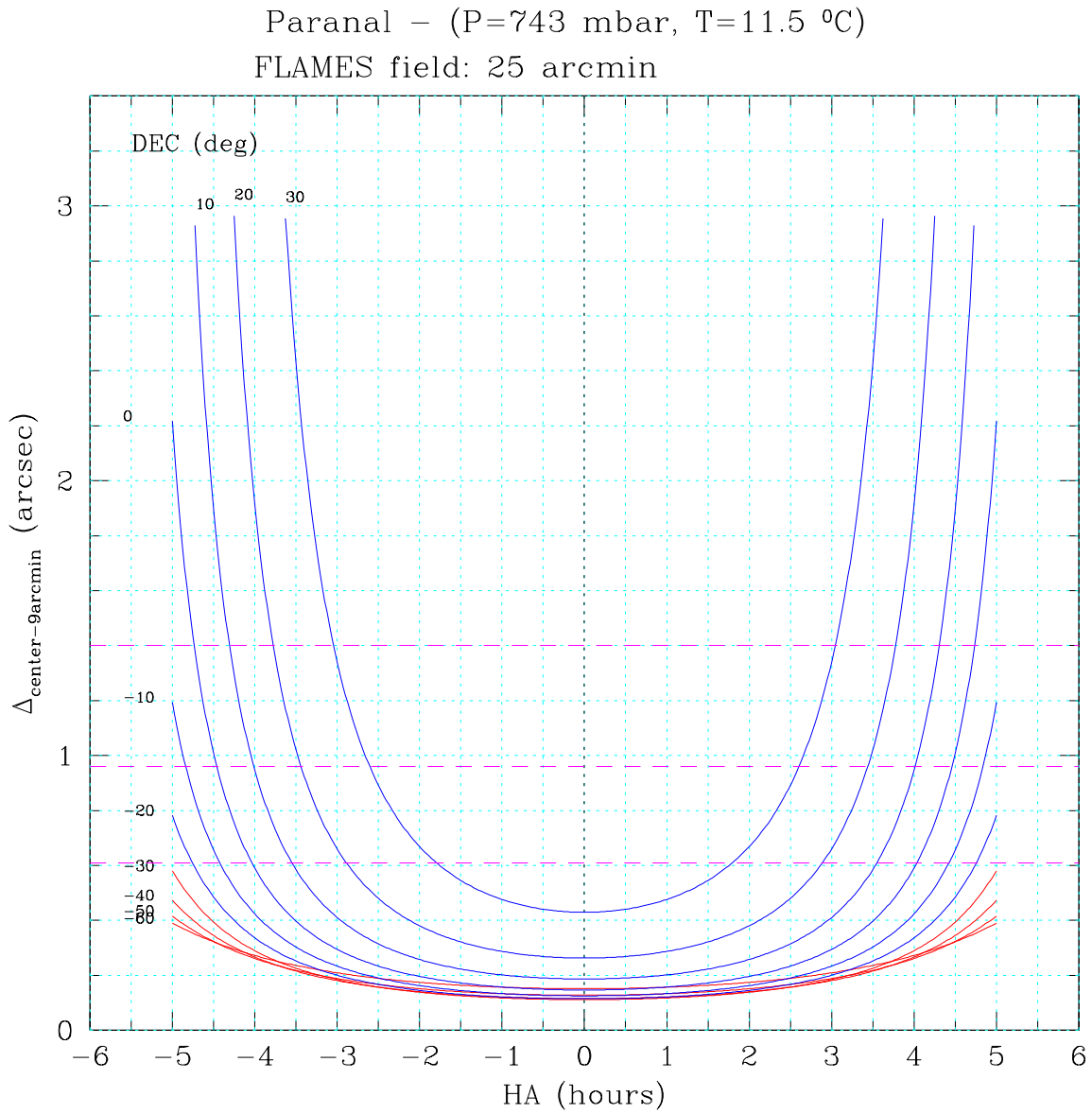

Figure 16: Distance between the field center and an object located 9 arcmin away from it, as a function of hour angle and declination of the field. The dashed horizontal lines indicate the loci of constant 2, 2.5 and 3 airmasses, from bottom to top, respectively. Computed for a wavelength of 400 nm.

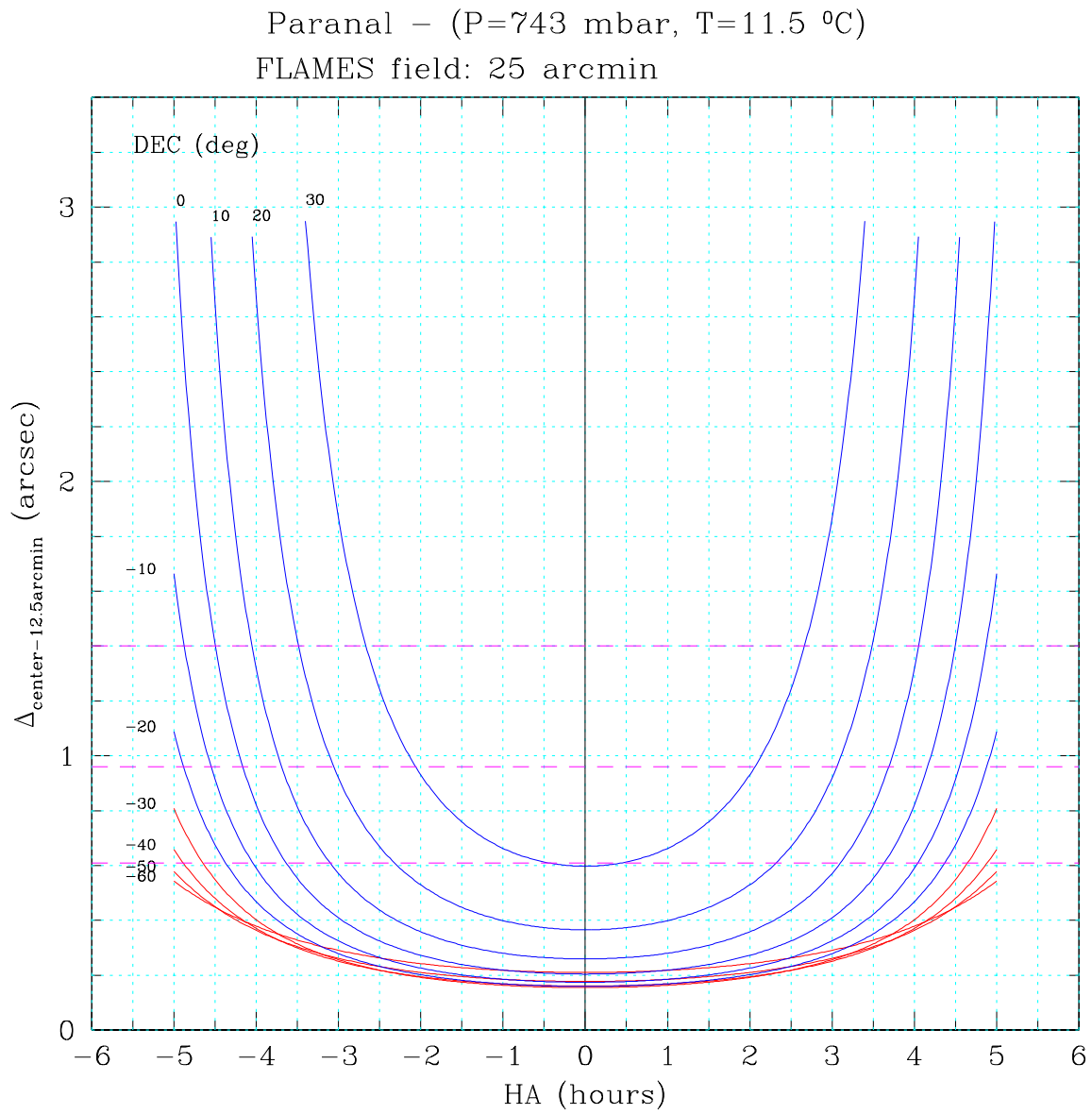

Figure 17: Same as previous figure but for an object located just at the edge of the field (12.5 arcmin from the center). Also for a wavelength of 400 nm.

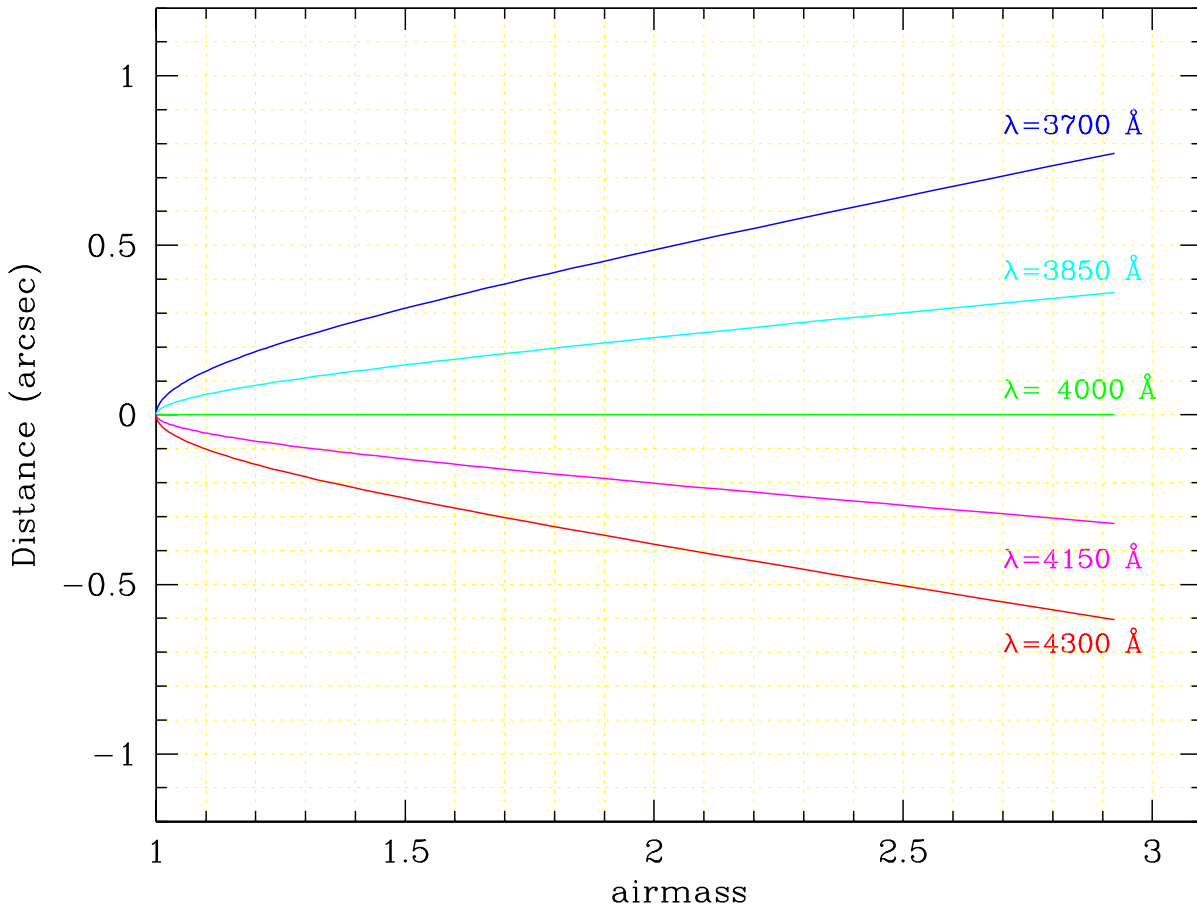

Figure 18: Relative displacement between the central wavelength $\lambda=400 \text{ nm}$ and nearby wavelengths covered by typical GIRAFFE gratings.

Each curve corresponds to a different declination, and indicates the size of the relative motion between the center of the field and the object as function of hour angles. The distance of 9 arcmin has been chosen as the radius enclosing about one half of the field area. For comparison, Figure 17 shows the same effect for a star located at the edge of the field, i.e., at 12.5 arcmin from the field center. The effect is obviously non-linear with the distance from the field center, becoming rapidly worse towards the edges.

Figures 16 and 17 refer to a central wavelength of 400 nm. Due to the dependence of the refractive index upon wavelength, the effect would be significantly smaller in the red than in the blue. The central λ of the observations is given as input to the acquisition template, in order to allow the telescope to guide on the same wavelength. However, different regions of the spectrum will be displaced with respect to the central one, and for large displacements they may fall outside the fibre entrance. Figure 18 illustrates the displacement between a central wavelength of 400 nm and four other wavelengths in a typical GIRAFFE spectrum covering a range of 60 nm. Two bluer wavelengths (370 and 385 nm) show positive displacement with respect to the central one (i.e., the offset with respect to their theoretical position is larger) while two redder wavelengths (415 and 430 nm) show negative displacements.

The FLAMES Fibre Positioner is designed to calculate the *mean* position of each object

during the exposure, knowing the field coordinates and the time of the observation. As shown in Figure 16, extremely rapid variations of airmass causes the position of an object close to the field edge to change by up to 2 arcsec in one hour exposure. For this reason, it is extremely important to carefully plan the duration of each single exposure, in order to minimize the flux losses due to the fact that **objects far away from the field center may move away from their fibre in the course of long exposures.**

Observers should make sure that their observations are confined to the flat part of the curves shown in Figure 16. For instance, fields at declinations below -30° can be observed continuously for 3-4 hours before and after their culmination. On the contrary, fields at declination between 0 and $+30^\circ$ can be observed for no longer than ~ 1 hour, and as close as possible to zero hour angle.

In order to allow the Fibre Positioner to calculate the mean position of each object during the exposure, it is necessary to provide an expected total execution time of the complete observation defined in the OB.

4.5 Preparing the Target Input Files

All the information regarding the targets are usually defined using the Observation Support Software (OSS), a number of software tools intended to assist the user in this process.

For FLAMES, the OSS consists of FPOSS, the Fibre Positioner OSS, i.e., a software package that takes an input file, with the target coordinate list, and allows the user to define (automatically and/or interactively) the way the FLAMES fibre have to be allocated to the targets.

For this reason, FPOSS is basically the core of the preparation of the FLAMES observations. The subsequent step, the definition of the observing sequence and exposure times with p2, is then relatively straightforward.

Instructions for downloading the FPOSS software can be found on the following page:

<https://www.eso.org/sci/observing/phase2/SMGuidelines/FPOSS.FLAMES.html>

The FPOSS user manual can be retrieved at:

<http://www.eso.org/sci/facilities/paranal/instruments/flames/doc/>

The target information flow starts with the creation of the target input file. The latter is fed to FPOSS, which then generates a Target Setup File containing the target, guide star, observing mode, fiducial stars fibre, and guide probe assignation. This Target Setup File is associated to an OB via p2. The content of the Target Setup File (plus additional information) is added as a FITS binary table to the final spectral images.

Since ESO has no means to check the correctness of the input file, the astronomer must be very careful; an error in such a file will propagate through the whole data flow without being detected.

The Target Input file is an ASCII file containing the following columns (see Figure 19 for an example and the FPOSS User Manual for details):

1. Object ID - MANDATORY -
2. Right ascension in hh mm ss.ss (J2000) - MANDATORY -

```

LABEL M67 central field
UTDATE 2001 04 23
CENTRE 08 51 22.82 11 50 09.4
*EQUINOX J2000.0
M67_00005      08 50 15.98   11 33 58.6   P 1 18.16   1 (B-V) = 0.614
M67_00006      08 50 26.13   11 33 59.2   P 1 19.80   2 (B-V) = 0.034
M67_00007      08 51 01.87   11 34 01.5   P 1 15.27   3 (B-V) = 0.008
M67_00012      08 52 04.43   11 34 10.2   P 1 19.51   4 (B-V) = 0.379
M67_00017      08 50 52.99   11 34 16.3   P 1 17.28   5 (B-V) = -0.008
M67_00020      08 50 22.52   11 34 20.8   P 1 15.53   6 (B-V) = 0.018
M67_00022      08 50 33.83   11 34 21.6   P 1 14.66   7 (B-V) = -0.209
M67_00023      08 50 42.31   11 34 22.0   P 1 18.69   8 (B-V) = 0.013
M67_00025      08 51 31.60   11 34 24.2   P 1 17.48   9 (B-V) = -0.064

```

Figure 19: Example of an input file for FPOSS.

3. Declination in $\pm dd mm ss.ss$ (J2000) - MANDATORY -
4. Object type: - MANDATORY -
 G = VLT Guide Star (Magnitudes ideally between $R \sim 9$ and $R \sim 11$, $R \sim 12$ for ARGUS).
 F = FACB (astrometric fiducial star: Field Acquisition Coherent Bundle). **Due to the limited dynamical range of the technical CCD, these stars must not have a difference in R-magnitude exceeding 3 magnitudes.** The absolute magnitude may be from $R=8-15$.
 P = Program target (same as M)
 M = MEDUSA target
 I = IFU target
 J = IFU SKY target
 A = ARGUS sky target
 U = UVES target
 S = Sky (generic, can be allocated by any fibre type)
5. Priority: 9 to 1, from 9 highest to lower, respectively - MANDATORY -
6. Target Magnitude
7. Target program ID (integer number)
8. Comments

Fields not labeled as MANDATORY are in fact optional for FPOSS. For possible additional information contained in the Comment field see the FPOSS manual.

4.5.1 Run FPOSS to Prepare the Target Setup Files

The FPOSS manual provides a full explanation of its use, here we give just a brief summary of the general concepts. The use of the FPOSS follows the following simple steps:

1. Loading of the input file with Guide, Fiducial, and Target stars
2. Selecting the VLT Guide star
3. Selecting the FLAMES observing mode
4. Assignment of the fibres to target objects
5. Assignment of the fibres to sky positions (if needed)
6. Checking configuration over hour angle range
7. Saving of the fibre assignment to the Target Setup File.

Once the saving is performed, a Target Setup File is generated, containing all the information necessary for the observation, with the exception of the spectrograph setup.

This file is of utmost importance. The files contains a checksum and must not be edited. If the file is edited, the following process (p2) will not proceed and will not be able to create OBs. Only Target Setup Files created by the FPOSS are accepted by the system.

4.6 Broken and low-transmission fibres

Although FLAMES fibres are mechanically very stable, the gripper might occasionally fail to move them, leading to the faulty fibre to be disabled. The large majority of the failures are due to dust on the plate and/or on the button itself and are readily solved (within 1-2 days) by cleaning the plate and button. However, it might happen that a button remains disabled for a longer time due to a more severe problem.

If the configuration file provided by the user makes use of a broken fibre, the problematic fibre is simply ignored by the system which places all available fibers leaving the broken fibres parked. Thus, if during phase II preparation a given target has been allocated to the problematic fibre, no data will be produced for this target. There is an additional detail. Since FLAMES has two observing plates available, the fact that a given fibre is disabled in one plate does not mean that the fibre with the same fiber number is also disabled in the other plate.

For instance, if object XYZ-1 has been allocated to fibre Medusa 116 and this fibre is broken in plate 1 but not in plate 2, then a spectrum of XYZ-1 will be produced when the user's OB is observed with plate 2 whereas with plate 1 no data will be collected.

Since the amount of broken fibres is small (1-2 per plate) most of the objects will have data produced by both plates. However, if the user has a have-to-observe target, he or she must pay attention to the list of broken fibres and not allocate this particular (and precious) target to any of the fibres in the list of broken fibers.

Note that since FPOSS doesn't know with which plate your configuration will be observed, it will allow you to allocate broken fibres. It is up to the user to manually correct the configuration (deleting allocations and re-allocating the target to another fibre by hand as described in the FPOSS manual) making sure that highly important targets are not allocated to any of the broken fibres².

Fig. 20 shows IFU sky spectra taken on plate 1 and on plate 2. Differences in the relative responses of the IFUs are clearly present within each plate although the absolute value in this case just depended on the sky brightness.

4.7 Introducing the Observation Blocks

An **Observation Block (OB)** is a logical unit specifying the telescope, instrument, and detector parameters and the actions needed to obtain a "single" observation. It is the smallest "schedulable" entity, which means that the execution of an OB is normally not interrupted as soon as the target has been acquired. An OB is executed only once; when identical observation

²The updated list of broken fibres is available at:

<http://www.eso.org/sci/facilities/paranal/instruments/flames/visitor.html#Fibres>

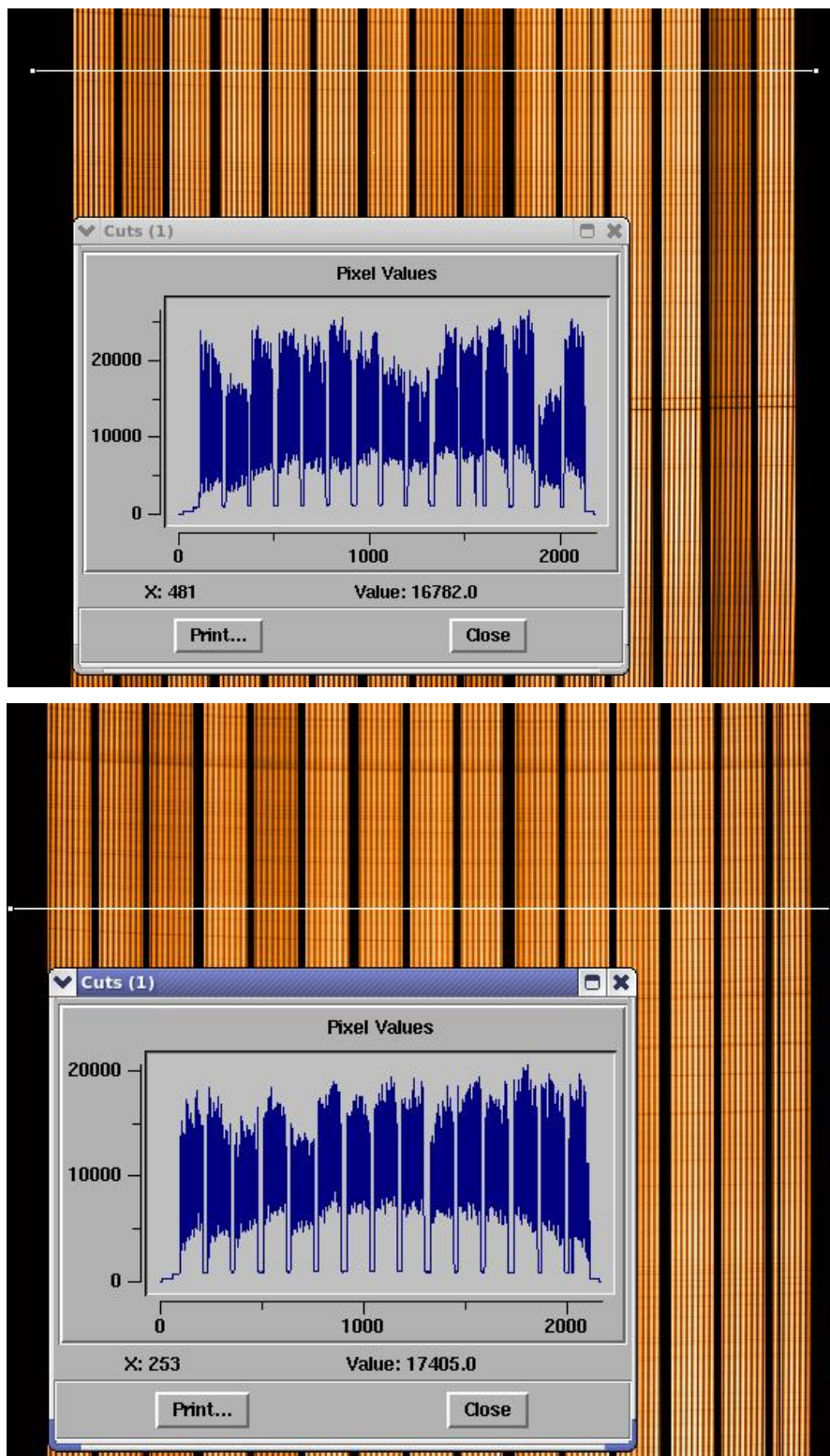

Figure 20: Raw GIRAFFE IFU images of the solar spectrum on plate 1 (top) and plate 2 (bottom) taken in May 2009. Variations in the IFU responses on each plate are clear although the absolute level depends on the solar illumination so this figure should not be used to compare the two plates.

sequences are required (e.g. repeated observations using the same instrument setting, but different targets), a series of OBs must be constructed. The detailed definition of FLAMES Observation Blocks and Templates are given in the *FLAMES Template Reference Guide* [1].

Usually, one OB consists of two separate entities: the acquisition template and the observation template(s). It is important to recall that, although not mandatory, it is much more convenient to repeat the fibre positioning when the same objects are observed through different setups, and/or very long integrations are required, in order to minimize the effects of the atmosphere (see § 4.4).

p2 will read the information regarding the targets from the Target Setup File. Note that *only the files produced by FPOSS are accepted by p2*.

4.7.1 GIRAFFE and UVES Exposure Time Calculators

The GIRAFFE and UVES – FIBRE mode **Exposure Time and Spectral Format Calculator (ETC)** is accessible through the ESO WEB page at:

<http://www.eso.org/observing/etc/>. The ETC models the instrument and detector in their different configurations. It can be used to compute the detailed spectral format (wavelength and order number as function of position on the detector) and the expected S/N for the specified target, atmospheric conditions as a function of exposure time. The ETC can also be used to access the efficiency curves of the various optical components as measured in the laboratory in advance of the installation.

While using the FLAMES ETC, the user has to keep in mind two fundamental points:

1. Some of the transmission factors are *mean* values: for instance, Table 4 shows how the corrector transmission varies with the distance from the field center. The ETC assumes a distance of 8 arcminutes. In the same way, fibre-to-fibre transmission variations are present at the 5 – 10% level. The ETC values are also mean values.
2. With an aperture of only 1.2 and 1.0 arcseconds on the sky (MEDUSA and UVES, respectively), the photon-collecting efficiency will strongly depend on the accuracy of the astrometry. The ETC is set to a default value of 0.3 arcseconds for the average object-fibre displacement. An option allows the user to specify the object-fibre displacement to evaluate the effects of bad astrometry on the photon-collecting efficiency.

4.7.2 Choice of the Sample Target

For the input flux distribution to the ETC, four options can be selected: (1) A blackbody energy distribution at a given temperature; (2) a power-law distribution; (3) a template spectrum: stellar spectra from spectral type O5 to M2, nebular spectra, galaxy spectra, or a quasar spectrum; (4) a single line at a wavelength, width, and flux level to be specified. In all cases but point (4) the object magnitude (in a given broad-band filter) has to be entered. For extended sources, the magnitudes are given per square arcsec. In addition to the target, it is necessary to enter the sky conditions (phase of the moon and FWHM of seeing disc).

4.7.3 Choice of Instrument Configuration and Spectral Format

Based on the properties of the optical components of the spectrograph, the format of the echelle spectrum covered by the detector depends solely on the selected central wavelength. The instrument templates with standard settings can be selected from the pull-down menu. The corresponding spectral formats are given in Tables 11 & 12 for Giraffe and 13 for UVES. The final entry is the exposure time.

4.7.4 Exposure Time and predicted Counts and S/N Ratios

The output of the ETC is a table listing the pixel size in wavelength, the computed efficiency, the total expected electrons for the object and the sky, the maximum pixel intensity (to monitor saturation), the predicted S/N ratio per extracted pixel in dispersion direction, the central wavelength and the wavelength bin size.

4.8 The p2 tool

ESO has released a web application p2 in support of the preparation of Phase 2 material of Paranal's service and visitor mode runs, including designated VM. From P101 onwards, PI's (and their delegates) of approved SM runs using FLAMES are requested to prepare their Phase 2 material with p2. An online demo is available here:

<https://www.eso.org/p2demo/home>

If the observations have been prepared carefully using FPOSS to define the FLAMES modes and targets-to-fibre assignments (as saved in the Target Setup File) and the ETC to define the required instrument setups and exposure times, the use of the p2 application is almost trivial: one acquisition template and one (or several) observing templates have to be combined in one OB.

FLAMES is fully supported by p2fc, the finding chart generator built into p2. Once the OB is complete, including the FPOSS setup file, simply click the "Generate Finding Charts" button in the "Finding Charts" tab of the p2 main window.

4.8.1 Acquisition Templates

There are 4 acquisition templates for FLAMES. The first three correspond to the three instrument modes (UVES, COMBINED and GIRAFFE). The fourth template is available in visitor mode only and is the *fast* acquisition in the ARGUS mode of GIRAFFE only.

In the first three templates the observer has to fill in the same (2) parameters only:

- a) Name of the Target Setup File created by FPOSS to be associated to the template (via a file selector box).
- b) Observing wavelength (from a pull-down menu with all FLAMES standard setups). In case of combined observations, both the GIRAFFE and UVES observing wavelengths have to be indicated.

Finally, the fourth template is for the *fast* acquisition mode of ARGUS, where no FPOSS setup file is needed. See the template reference manual for details.

4.8.2 Observing Templates

There are 5 observing templates, one for UVES, one for GIRAFFE, one for COMBINED and two for ARGUS. In the first three cases only a few parameters are required to be given:

- a) Setup (grating, central wavelength, and readout mode from pull-down menu).
- b) Observing time for each exposure. Note that UVES and GIRAFFE may have different exposure times!
- c) Number of exposures
- d) Switch for the simultaneous calibration (GIRAFFE only). Set to OFF in case negative effects on your observations are expected.

Of course, in case of COMBINED observations, this information needs to be given for UVES and GIRAFFE separately. For the final two (ARGUS) cases, the OB must include the information above, plus three additional parameters:

- e) Number of offsets.
- f) List of offsets in Right Ascension.
- g) List of offsets in Declination.

4.8.3 Computing Time Overheads for your Programme

With the **Exposure Time Calculator**, the user obtains an estimate of the observing time needed to reach the desired S/N depending on the object magnitude and observing configuration. To compute the total observing time required for the programme, one needs to add the time for all actions required to carry on the scientific observation. When applying for service or visitor mode observations, the **computation of the overheads is required** and has to be included in the application.

The following estimates of the overheads must be used and are also the basis for the automatic calculation of execution times within the p2 tool, used for the final definition of the OBs in service and visitor mode:

- **Target Acquisition: ~ 13 minutes (except ARGUS fast Visitor Mode only which is 8 minutes)**

The target acquisition includes the configuration of UVES fibres, the homing of the telescope rotator to zero degrees, the swapping of the plates, and the acquisition of the field: ~7 minutes. The telescope preset, acquisition of the guide star, and start of the active optics account for an additional ~6 minutes.

- **GIRAFFE and UVES Instrument setup: 1 minute**

A new instrument setup takes 1 minutes for GIRAFFE and UVES.

- **GIRAFFE and UVES CCD readout: 1 minute**

The readout time for the CCD mosaic in the UVES red arm and for GIRAFFE CCD is 1 minute each. In combined mode all CCDs can be read in parallel.

- **Plate Configuration: 0 - 20 minutes**

Plate configurations take 20 minutes at most (MEDUSA mode). This does **not** translate into overheads if the running exposure on the other plate is at least 20 minutes long. Plate configuration overheads are to be taken into account only when the exposure time on one plate is shorter than 20 minutes.

- **Nighttime Screenflat Calibration: ~7 minutes**

If attached screen FF calibrations are requested at nighttime, they will need (on average) 7 extra minutes. Note that the attached FF exposure time strongly depends on the wavelength. **It is almost impossible to get sufficient flux with a decent exposure time for the bluest setups.** The in-use exposure times for attached screen FF can be found in Table 14 ($=t(\text{FF}, \text{screen})$). The exact attached FF exposure time has to be taken into account when computing overheads. Note that in an attached (NasA) flatfield in the bluest three HR settings there are typically only a few hundred ADU detected in a 20-minute exposure time in the bluest part of the CCD. Hence accurate flatfielding for the HR1, HR2, HR3 and LR1 settings for **ARGUS ONLY** is not presently possible within service mode. These four settings are therefore only offered in **VISITOR MODE IN ARGUS** to allow for more time to take the attached flatfields in the daytime. Even then the number of derived counts obtained at the far blue end may only be around a thousand in a few hours. For Medusa and IFU the robot flats may be used so all setups are accepted in Service or Visitor mode.

- **Daytime Calibrations: 0 minutes**

Bias frames, flatfield and Th-Ar calibration lamp exposures are taken only during the day with the same instrument and detector setup as the science exposures. Standard calibrations are carried out automatically by the Observatory. No overheads need to be accounted for.

5 The Calibration of FLAMES Data

5.1 General Concept

Given the possibility of using two spectrographs in many setups, the possibility of obtaining suitable calibrations has been a constant concern for FLAMES. The operation concept relies on the fact that all necessary calibrations can be taken during the day, and they have an accuracy level to guarantee that a sky subtraction to better than 2% is possible. To achieve this goal a high photometric fibre stability is required, and an overall high instrument setup repeatability and stability. All calibrations are carried out using the calibration unit of the Fibre Positioner (see next section and Section 2.3).

As described in the other Sections, a fast and a slow readout mode are offered, both in visitor mode only. This choice is explained by the fact that no calibration database currently exists for these special readout modes. And it is not possible to deal in service mode with different readout modes at the same time due to the time used by the calibrations to be taken. For the same reason, the observatory cannot guarantee to provide a quick-look reduction of observations with these modes. However, the calibrations necessary for data reduction are taken in advance on a best efforts basis, to allow visitors to reduce the data locally in real time.

With the exception of the attached Nasmyth FF calibrations, the observer is not supposed to prepare any calibration OBs: calibrations will be provided by the Observatory, following the *FLAMES Calibration Plan* [3].

5.2 Positioner Calibration Unit

The positioner calibration unit has been conceived to provide the user with the following performance:

- Fibre-to-fibre relative flux illumination flat field: relative illumination better than 0.3%. This ensures that accurate fibre-to-fibre relative transmission can be derived using the flat spectra acquired with the positioner.
- Integration time per button: less than ten seconds. For a flat field level of at least 8000 e⁻/pixel, and for a Th-Ar level of at least twenty lines per GIRAFFE setup. This is valid for the majority of the setups. In the BLUE setups calibrations require longer integration time and the targeted flux cannot always be obtained.

This performance has been obtained using a mixture of hardware and operations. The fibres to be calibrated are first positioned following a spiral pattern on the plate. In order to guarantee the same flat field relative illumination, it is necessary to minimize lamp variability. This is achieved by sweeping the gripper above the fibres several times; the gripper movement is so accurate to guarantee the same illumination time/fibre to a level of a fraction of percent.

These flats can be therefore used for both, flat fielding and fibre to fibre transmission measurement purposes.

In the case of Th-Ar exposures, the gripper moves from one fibre to the next and dwells on the fibre for a given amount of time, then goes to the next.

For ARGUS calibrations (both flats & arcs), the robot first illuminates the sky fibers by sweeping in front of them with its lamp on. Then, it illuminates the ARGUS array (which is located at the center of plate 2, see Fig. 9) by scanning over it with the lamp on. As a consequence, the total times exposure time is \sim twice the IFU one (\sim half for sky fibres and half for the array).

5.3 Nasmyth Screen

To perform a very accurate sky subtraction, it may be useful to acquire Nasmyth screen flat fields (or so-called attached flats). These flats are obtained by illuminating the closed Nasmyth shutter with halogen lamps after the observations. The fibres are not moved at all from their observing positions during this type of calibration. They are maintained with the same geometry and torsion property. This ensures the minimum difference between observing and calibration conditions, but on the other hand, especially for wavelengths bluewards of 420 nm, it is **very** (night-)time consuming. For this reason starting in P84 the observatory only offers ARGUS HR1, HR2, HR3 and LR1 observations in **visitor mode** where more time will be available during the day on a best-effort basis to obtain more screen flatfields. Medusa and IFU systems remain available for all settings in service or visitor mode as they can use flatfields taken using the robot.

5.4 Simultaneous Calibrations

GIRAFFE is equipped with five simultaneous calibration fibres per slit. Unless explicitly avoided by the user in the observing template, every spectrum contains five simultaneous arc spectra, evenly located along the CCD 2k width. These spectra can be used to track the wavelength solution for all the fibres.

Tests on solar spectra during GIRAFFE integration in Garching reached high accuracy over a few days, and tests on stars during commissioning showed that an accuracy of 70 m s^{-1} can be obtained on a time basis of a few hours for slowly rotating cool stars. This was reached in 15 minute exposures for objects brighter than 14.3 magnitude in the HR09 setup (cf. The ESO Messenger, 110, 1).

For FLAMES-UVES the radial velocity instrumental error is about $30\text{--}50 \text{ m s}^{-1}$ when using the 7+1 mode which includes a fibre dedicated to simultaneous calibration (580-nm only, Astronomy & Astrophysics, 421, L13).

5.5 Longslit Calibrations

5.5.1 GIRAFFE Longslit Unit

One of the slits of GIRAFFE is equipped with a longslit unit, which is used for engineering purposes; calibrations obtained with this unit are of no interest for the observer.

5.6 The UVES Calibration Unit

The UVES calibration unit is a mechanical structure mounted on the Nasmyth rotator flange, which in the case of UVES is kept fixed during observations. It hosts continuum lamps which, in combination with various filters, are used for flatfield calibration and one Th-Ar lamp for wavelength calibration. The lamps are mounted on an integrating sphere and relay optics simulate the F/15 telescope beam. The light from the lamps is fed into the instrument beam by 45° mirrors mounted on a slide.

The flatfield spectra provide a good correction for the blaze function of the echelle. They correct the pixel-to-pixel variation in CCD sensitivity as a function of the wavelength of the light. In the red part of the spectra ($\lambda \geq 650$ nm) narrow fringes with peak-to-valley amplitudes up to 30% are present on the EEV CCD of the mosaic. On the MIT-LL CCD, the fringes are less sharp and of smaller amplitude.

In the fibre mode of UVES, long slit spectra are acquired with a slit longer than the extent of the fibre slit to ensure that even in case of small shifts between the observation and the calibrations, the detector area covered by the fibres is covered by the long slit spectra. Pixel-to-pixel variations can be reduced in this way.

5.7 Fibre to Fibre Transmission and Sky Subtraction issues

When dealing with fibre spectra proper sky subtraction is a concern. For some science cases this may be the limiting factor on the quality of the reduced data. In the present scheme (i.e., without nod and shuffle technique) it is critical to characterize the fibre to fibre relative transmission with excellent accuracy. This task is not always trivial, because fibres may develop photometric instabilities which depend on their history and on the way they are routed. In FLAMES we have ensured that in normal operating conditions, the fibre system is constant to better than 1% stability. At this point, the most critical issue is to find a way to uniformly illuminate the fibres. This task is done by the positioner.

Other steps to obtain a correct sky subtraction involve a) the knowledge of the transmission of the corrector, which is given in Table 4 as a function of wavelength and position on the field of view and b) a good spatial distribution of the fibres, which can account for sky variations in the field of view. It is also important that enough fibres are allocated to the recording of the sky.

Fig. 21 shows an example of a GIRAFFE image of exposure of 2750-s taken with Carreras at a wavelength of L881.7. Aside from the many cosmic rays present, the attention of the reader is drawn to the many sky emission-lines present at this and other red settings. Fig 22 shows extracted spectra which emphasise the strength of the sky lines.

Before submitting a proposal PIs should consider downloading previous GIRAFFE spectra from the ESO archive to see how badly their spectra will be contaminated by sky lines. We note that the current version of the GIRAFFE pipeline does **not** perform sky subtraction. PIs should consider referring to the following articles (amongst others) on how to remove sky features in FLAMES data:

- Battaglia et al., (2008), MNRAS, 383, 183. Contains a detailed description of how sky lines can be removed from FLAMES-GIRAFFE spectra.

- Koch et al. (2007), AJ, 134, 566. An estimate in the final accuracy of sky subtraction of ~ 3 per cent is given for Leo spectra.
- Koch et al. (2006), AJ, 131, 895. An estimate in the final accuracy of sky subtraction of ~ 2 per cent is given for Carina spectra.
- Peuch et al. (2014), SPIE, 2014SPIE.9147E..6LP

5.7.1 New strategies for sky subtraction

In the framework of the phase A of two fiber-fed spectrographs, technical observations have been carried out with FLAMES/GIRAFFE to test the accuracy of two sky subtraction strategies: (1) Dual fiber bottom in stare mode. The sky is sampled simultaneously in the immediate vicinity ($< 12''$) of the object by a sky fiber associated to the object fiber. This setup is close to a pseudo slit. (2) Cross Beam Switching - Each science target has two fibers associated, as in the dual fiber mode. The telescope is offset by the same distance that the separation of the pair fibers. Each fiber is thus switched between an object and a sky position. The object is observed in the fibers following a sequence A B B A or A B A. This strategy has the advantage to observe the sky background with the same fibers used for the targets. The preliminary results of these observations show that both methods reach accuracy and precision of the sky subtraction under 1%, in I-band. In contrast to the commonly held view in the literature, this result points out that fiber-fed spectrographs are adapted for the observations of faint targets. More details are given in Rodrigues et al. (2012), *On-sky tests of sky-subtraction methods for fiber-fed spectrographs*, Proc. SPIE 8450, Modern Technologies in Space- and Ground-based Telescopes and Instrumentation II, 84503H (September 13, 2012)

5.8 Special Calibrations

5.8.1 Detector Flats

Detector flats from direct illumination of the CCD through the camera only are taken at regular intervals by the maintenance staff to monitor the CCD performance. They (and all other calibrations) are available from the ESO VLT Science Archive at <http://archive.eso.org>.

5.8.2 Use of Telluric Standard Stars to correct for Fringing or atmospheric Lines

Stars with featureless spectra (typically white dwarfs or fast rotating hot stars) can be used to provide a good template to correct for fringing as an alternative to the use of internal flatfield lamps. These spectra can also be used to identify and estimate the depth of atmospheric H₂O and O₂ absorption lines. In case these are required, we suggest that the users insert some of these objects among their targets.

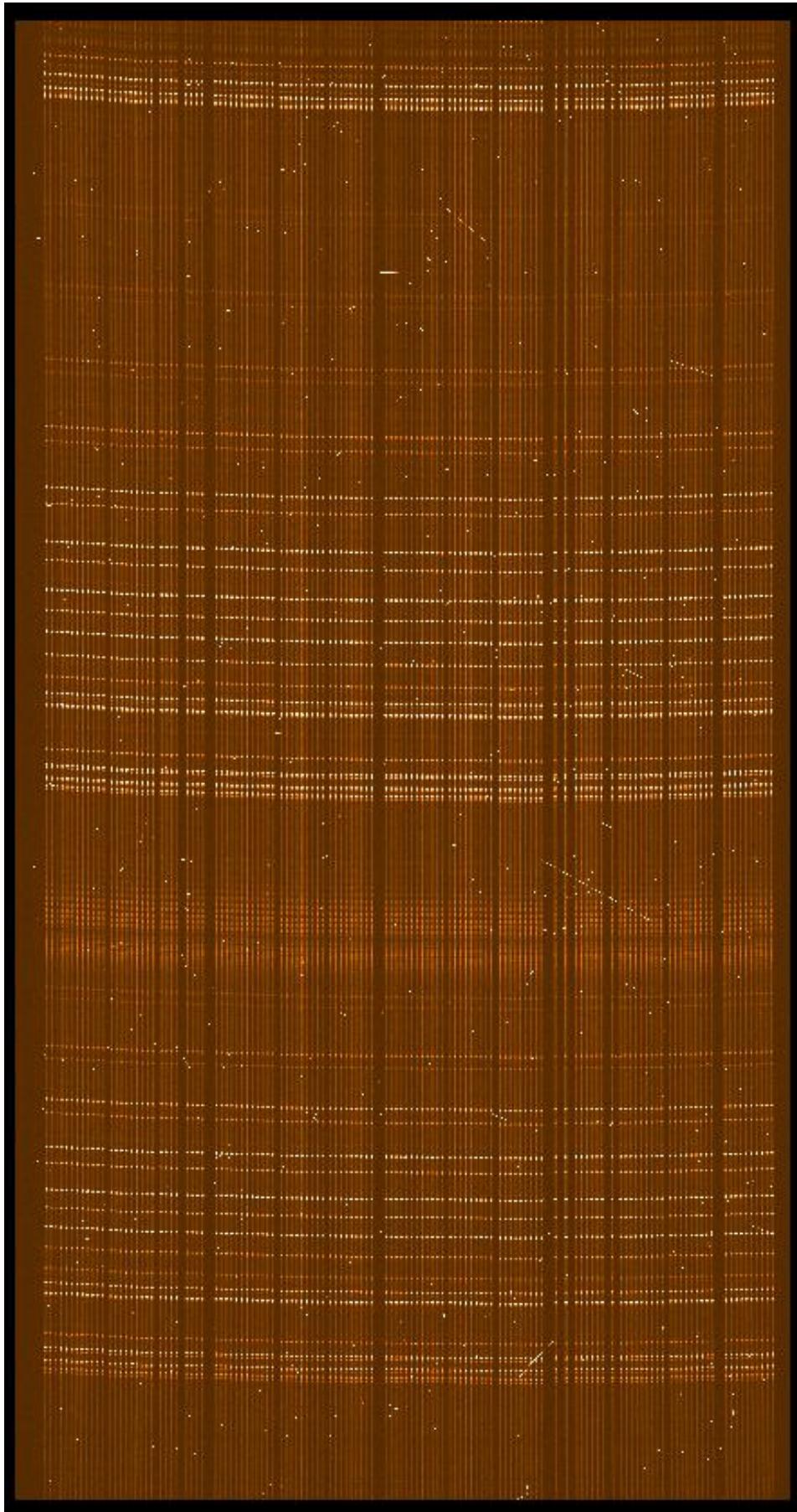

Figure 21: This image shows how especially in the red that there are many sky lines. Removing them can be critical to obtaining good science output. The exposure was taken using GIRAFFE at L881.7-nm for 2750-s.

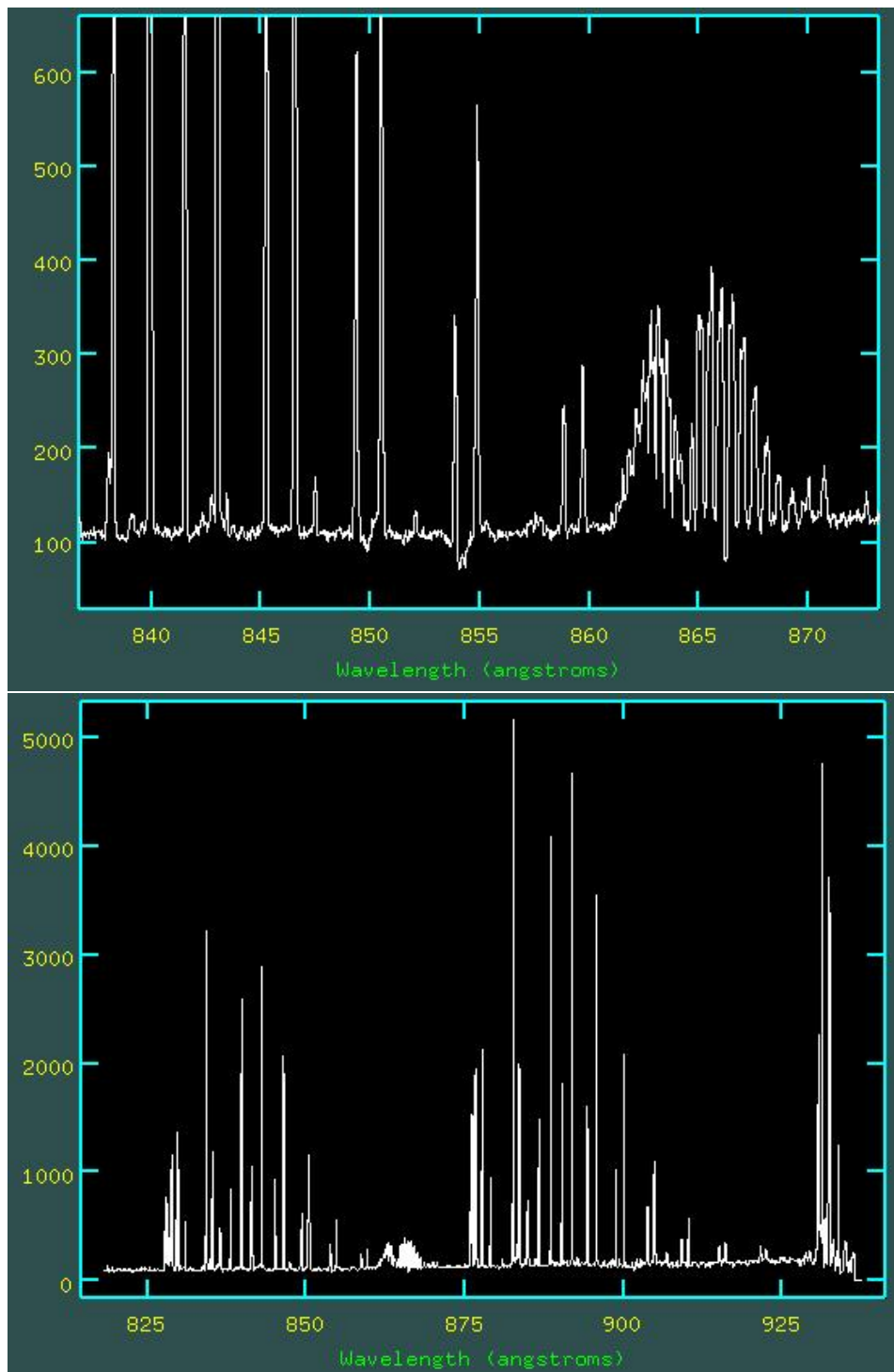

Figure 22: Extracted spectra of the image in Fig. 21 showing a number of bright sky emission lines.

5.9 FLAMES Science Calibration Plan

Table 5.9 provides a summary of the FLAMES Science Calibration Plan as defined in the *FLAMES Calibration Plan* [3]. We note that specphot standards are generally selected by the nighttime astronomer from the list available at :

<http://www.eso.org/sci/observing/tools/standards/spectra/>

FLAMES – UVES Science Data Calibration Plan

(per instrument setting: plate, fibre mode, and central wavelength)

Calibration	num.	freq. [1/days]	purpose
Robot Flatfields	1	1 / 1	pix-to-pix sensitivity variations fibre-to-fibre transmission fibre localisation fibre PSF modelling blaze correction
Slit Flatfields	3	1 / 7	pix-to-pix sensitivity variations
Attached Fibre Flatfields	<i>n</i>	o.r.	high-precision flatfielding
Wavelength	1	1 / 1	dispersion solution resolving power
Sim. Fibre Order Definition	1	1 / 1	order and background def.
Sim. Fibre Format Check	1	1 / 1	dispersion guess solution
Bias	5	1 / 1	master biases, bias chars.
Dark	3	1 / 30	master darks, dark current, cosmic rate

FLAMES – GIRAFFE Science Data Calibration Plan

(per instrument setting: plate, fibre mode, resolution and central wavelength)

Calibration	num.	freq. [1/days]	purpose
Robot Flatfields	3	1 / 1	pix-to-pix sensitivity variations fibre-to-fibre transmission fibre(=spectra) localisation
Attached Flatfields	<i>n</i>	o.r.	high-prec. flatfielding, Medusa
Attached Flatfields	3	1 / 1	high-precision flatfielding, Argus or IFU
Wavelength	1	1 / 1	dispersion solution resolving power slit geometry
Bias	5	1 / 1	master biases, bias char.
Dark	3	1 / 30	master darks, dark curr., CRs
IFU: Flux Standard	1	1 / 7	response corr. flux calib
Attached Flats	3	1 / 1	rel. trans. IFU / Sky fibres
ARGUS: Flux Standard	1	1 / 7	response correction, flux calib
Attached Flats	3	1 / 1	rel. trans. ARGUS / Sky fibres

o.r. = on request only, corresponding OBs to be provided by user

n = number to be defined by user

6 FLAMES Observing Operations

This chapter explains in some detail the operation of FLAMES. A sound understanding of the rather peculiar FLAMES operations procedure is crucial for good planning of visitor AND service mode observations. We summarize again a number of particulars which need to be taken into consideration for FLAMES operations:

1. The relative distance between objects is going to change during an observation, therefore in general long observations should be avoided.
2. Observations of the same objects at different wavelengths or multiple observations of the same objects should be executed only after re-positioning of the fibres.
3. The Fibre Positioner configures while observing; this implies that two OBs are running at the same time. Also, the positioner needs to know the mean time of the next observation while the current one is still running. In practice, it gives some rigidity to the whole operation scheme.
4. When used in combined mode, FLAMES produces UVES and GIRAFFE frames.
5. Each FLAMES sub-system (Positioner, GIRAFFE, UVES) has its own Observing Software (OS). The complete system is coordinated by the FLAMES Super-OS which is the only OS allowed to talk to the Telescope Control Software (TCS). The frames produced by the spectrographs are complemented with information coming from the TCS.

6.1 During the Night

Observations with FLAMES are carried out at the Console of UT2, located in the VLT Control Building just below the Paranal summit. From there, all telescopes and instruments are remotely controlled. The telescope and instrument operator carries out the observations and checks that they perform correctly; the main responsibility of the visiting astronomers is the selection of the OBs, based on the sky conditions and on the results of the first observations.

The GIRAFFE and UVES – FIBRE mode raw data are saved in the FLAMES workstation. After the data has been transferred to the Archive workstation, copies of the files are received on the astronomer's offline workstation and on the pipeline workstation where the automatic data reduction is running. The pipeline products are eventually forwarded to the astronomer's offline workstation (Note that the UVES – FIBRE pipeline has been available from April 2003, the GIRAFFE pipeline from April 2004).

Given the necessity to run target assignation at the Fibre Positioner together with target observation at the telescope, two BOBs (Broker for Observation Blocks) are running simultaneously. Although the two BOBs are perfectly symmetric and exchangeable, for the sake of simplicity we will call BOB-obs the one observing and BOB-config the one configuring.

The Target Setup File generated by the FPOSS (associating the fibres to the object coordinates) is linked to the OB through p2.

The OB is read by BOB-config and the acquisition template is executed. The positioner SW knows the actual time, the expected execution time of the OB (as provided by the user) and computes the mid-time of the new observation. The coordinates are transformed into

plate R, θ positions, the back-illumination is switched on (about 30 milliseconds/fibre) and the buttons are placed. Once the configuration of the plate is completed, it receives a unique identifier (say plate-1) and a validity time-stamp is generated.

When the OB is re-run (on BOB-obs), it looks for the status of plate-1. Finding it at the configuration position, i.e., at the robot, and knowing that no other observation is running on the telescope side, it sets the telescope rotator back to the home (=zero) position, disengages the current plate, rotates the tumbler, and engages the new plate.

At this point the center field coordinates are sent to the telescope and to the rotator. The VLT field acquisition can start: search for guide star, closing of the active optics loop, and field stabilization. The four FACBs check that the fiducial or reference stars are indeed in the right position or of needed telescope offsets are computed and applied. The acquisition template is now finished and the observing template can start.

While running the observing template on BOB-obs, the next OB can be selected and run on BOB-config which, after some sanity checks, starts the configuration of the next field.

Clearly this cycle is very critical, and once started, there is not much room for maneuver. Usually, if some observations require repetition, the plate will need to be reconfigured, the field be re-acquired and re-executed after another OB has been executed.

6.2 Pointing and Guiding

FLAMES is not equipped with any auxiliary slit viewer or imaging system in addition to the 4 FACBs, therefore the whole system relies on the (relative) accuracy between the targets, the VLT guide star and the 4 FACBs.

After the telescope has been pointed, the images from the 4 FACBs are recorded on the technical CCD and the centroids in each of the quadrants are computed and offsets calculated. **The fiducial stars in the FACBs are therefore the ONLY sources linking the geometry of the plate to the sky.**

The target, VLT guide star and fiducial (FACBs) coordinates must be in the same reference system (i.e., their coordinates must be computed from the same astrometric solution) with a relative accuracy better than 0.3 arcseconds to avoid wasting telescope time.

In order to guarantee a correct centering and offset calculation, FACB reference stars should not have close visual companions (within 3 arcseconds). **Telescope Guide Stars should have magnitude R between 9 and 11 (12 for ARGUS). FACB stars should be brighter than $R \sim 15$ and be of comparable magnitude: within 3 magnitudes. This latter requirement was imposed by the small dynamics of the FLAMES technical CCD (0–4095). Recently, a new technical CCD has been installed. The dynamics of this new chip is enhanced: 0–65 535 but it is still recommended to use FACB stars with similar magnitudes.**

Recent images will help to minimize errors due to neglected proper motion in the targets / guide / fiducial stars.

The tracking of the telescope is corrected for errors of low frequency (< 1 Hz) by an autoguiding facility. The autoguider makes use of a **guide star** observed by the guide probe in the adaptor-rotator that is moved into the telescope beam. The guide star is selected by the observer in

the input file to the FPOSS and needs to be in the same coordinate system as the targets and of the fiducial (FACBs) stars.

Once the telescope acquisition and active optics correction is executed, some small shifts may still be present between the telescope and the target coordinates. When the four FACBs start working, the offsets of the 4 stars are computed and the operator may apply them to center fiducial stars on the FACBs. After the centering is considering satisfactory, the observing template can start and the science integration proceeds.

6.3 ARGUS fast observations

In Visitor mode **only**, it is possible to move from field to field and take observations of different science targets at different wavelengths without reconfiguring plate 2, at the centre of which ARGUS is located. These observations rely on the VLT guide star, and hence do **not** use the FACBs. These observations are performed using the `FLAMES_giraf_acq_argfast` acquisition template. The 15 ARGUS sky single fibres are placed in a circle with radius defined by the user. Use of the template saves time as swapping the plates back and forth is not necessary. However, swapping is avoided **only** if (a) The ARGUS sky fibres are at the same radius and/or not used (b) The plate scale is the same for the two observations.

Note that the `FLAMES_giraf_acq_argfast` template can be used with any of the following observation templates:

- `FLAMES_giraf_obs_argoff` (science target with offsets)
- `FLAMES_giraf_obs_argstd` (standard star observation with offsets)
- `FLAMES_giraf_obs_exp` (“normal” Giraffe science template)

6.4 Evaluation of the Results, Offline Data Analysis

At the end of each integration, the CCD frames are read out by the FIERA controller and transferred to the instrument workstation and subsequently to the archive.

During the readout the frames are displayed automatically on two Real-Time Display (RTD) panels (one for GIRAFFE, one for UVES) for first inspection using the standard RTD tools. More detailed analysis of the new exposures or previous exposures has to be carried out on the astronomer’s offline workstation where copies of the raw files are available within a few seconds. After pipeline processing, the pipeline products are also forwarded to the offline workstation from where they can be accessed and inspected by the astronomer. Note that it is possible that the pipeline does not fully support the slow and fast readout modes in case of use in visitor mode. Standard data reduction tools like MIDAS, IRAF, or IDL are available for this purpose.

The rather complex data structure of FLAMES raw frames is described in the next section.

6.5 FLAMES Raw Data Structure

Given the complexity of the instrument, the data must carry all the relevant information about the objects and the instrument configurations through the whole data-flow process. In the case of FLAMES, two binary tables associated to the detector image are of utmost importance, because they contain all the information to associate the spectra to the objects.

Both GIRAFFE and UVES – FIBRE mode FITS data have the same data and header structure and include 3 FITS HDUs (Header Units):

HDU1: image the image header contains in addition to the primary FITS keywords additional keywords for the status of telescope, positioner, spectrograph, detector, templates, etc. during the exposure.

HDU2: OzPoz_table associates the objects to the fibre buttons. This is basically the same table as was provided in the Target Setup File for FPOSS, plus additional information from OzPoz, such as the R and θ position of each button on the plate and the corresponding positioning errors. The table header contains keywords related to the fibre positioning process, e.g., the time and wavelength for which the field was configure.

HDU3: FLAMES FIBRE Table contains the fibre description: association between fibre buttons and position in the subslit and slit, measured (laboratory) fibre transmission at different wavelengths, fibre bundle. For the ARGUS fibre bundle, the X and Y position of the individual fibre in the reconstructed image matrix is given.

6.5.1 HDU2: OzPoz_table

The OzPoz binary table will be different for every frame; this table associates the objects to the fibre buttons. The basic information for this table is taken from the Target Setup File (association object-to-fibre and object characteristics). This information is complemented by OzPoz with all information related to the positioning of the fibres.

The table is structured as:

Col 1: Object Identification (from Target Setup File, column 1)

Col 2: RA Right Ascension (from Target Setup File, column 2)

Col 3: DEC Declination (from Target Setup File, column 3)

Col 4: R Button R position on plate (microns)

Col 5: R_Error Error in R (microns)

Col 6: Theta Button θ position on plate (radians)

Col 7: Theta_Error Error in θ (microns)

Col 8: Type Object type (MEDUSA, IFU, etc...)

Col 9: Button OzPoz button number

Col 10: Priority Object Priority (from Target Setup File, column 5)

Col 11: Orient Button Orientation

Col 12: In_Tol T or F if positioned or not within tolerance (40 microns = 0.08")

Col 13: Magnitude Target Magnitude (from Target Setup File, column 6)

Col 14: Comments User comments (from Target Setup File, column 8)

The table FITS header contains additional information from the configuration process. The following compiles the most important keywords:

Keyword	Example Value	Comment

--- Information from Target Setup File -----		
FILENAME	'w_Cen_.COMMED8.025151'	Configuration file name
CENRA	201.700124999997	13:26:48.03, Field centre mean RA (Degrees)
CENDEC	-47.5219444444436	-47:31:20.0, Field centre mean Dec (Degrees)
CENEQNX	2000.	Equinox of Field Centre (FK5 Julian)
ALLOGGUI	4	Number of allocated FACB stars
ALLOCOBJ	122	Number of allocated objects
ALLOCSKY	18	Number of allocated sky positions

--- Information from Configuration Process -----		
ACTMJD	52808.9479166665	Actual MJD of tweak time (*)
ACTUTC	'2003-06-18T22:45:00'	Actual UTC of tweak time (*)
ATMPRES	745.7	Atmospheric pressure (millibars)
ATMRHUM	8.	Atmospheric relative humidity (percent)
ATMTEMP	13.4	Atmospheric temperature (celsius)
PLATE	1	Identifier of the used positioner plate
FACBWLEN	730.	FACB wavelength (nm)
GIRAWLEN	679.7	GIRAFFE wavelength (nm)
UVESWLEN	580.	UVES wavelength (nm)

-- If ARGUS was used -----		
ARGUSED	T	Flag indicating if ARGUS used
ARGSCALE	'1:1'	ARGUS Scale
ARGPOSAN	90.	Position Angle of ARGUS on sky (Degrees)
ARGANGLE	0.	Orientation of ARGUS (Degrees)

(*) tweak time refers to the time for which the field was configured.

6.5.2 HDU3: FLAMES FIBRE Table

This table is a 'static' table, in the sense that for all files of a given period it should be the same. This table contains the association between the fibre buttons and retractors and the slit position, and the transmission of the fibres as measured in the laboratory before shipping to Chile. The table is changed only when some major problem or change occurs, e.g. that a fibre subsystem needs to be replaced with a spare. Several of the data contained are useful for engineering purposes, the reader is invited to concentrate on field 2 (FPS) and field 8 (RP), which give the position in the slit and the position number of the button on OzPoz respectively. One example of this table can be retrieved via the web from

<http://www.eso.org/observing/dfo/quality/GIRAFFE/txt/fibre.dat>

Schematic examples for the raw data format of the different fibre types are given in Appendix 7.1.

Description of the table columns:

- Col 1: Slit** Slit name from fibre type and plate number
- Col 2: FPS** Progressive fibre position number in the slit
- Col 3: SSN** Subslit number
- Col 4: PSSN** Fibre Position in the subslit
- Col 5: Retractor** Serial Number of the retractor
- Col 6: BN** Serial Number of the button used in the retractor
- Col 7: FBN** Serial Number of the fibre used for the button
- Col 8: RP** Retractor position on the plate. This number corresponds to the **fibre number** used e.g. in FPOSS. All even numbers are MEDUSA fibres
- Col 9-17: wave** Fibre Transmission values as measured in the lab. Each column is a different wavelength
- Col 18: X** x position of fibre in the reconstructed image matrix
- Col 19: Y** y position of fibre in the reconstructed image matrix
- Col 20: FPD** Fibre Position on the Detector. For all setups except ARGUS this is the same as FPS. For ARGUS it is reversed. Added April 2004.

Note that the ARGUS image reconstruction using the x and y columns for the table will give the image in the standard North – East orientation on sky. If the ARGUS position angle was 0 ($\text{ARGPOSAN} = 0$), N is along the X axis and E along the Y axis. A non-zero PA is shown in Figure 23). The position angle is counted in the standard sense, i.e., N to E.

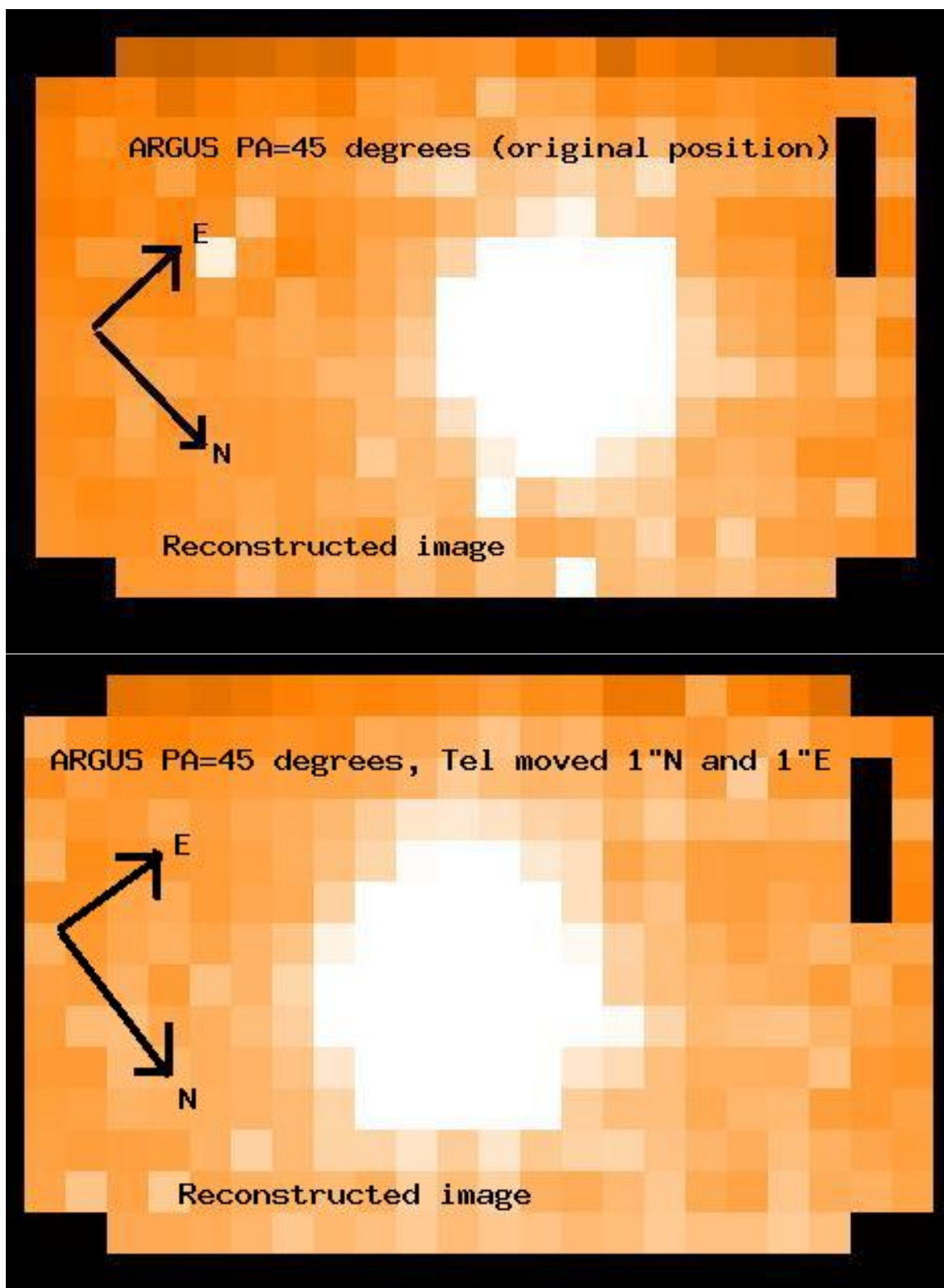

Figure 23: Argus reconstructed image with Argus position angle in the acquisition set to +45 degrees. Top panel: Original pointing. Bottom panel: Telescope moved by 1.0 arcseconds North and 1.0 arcseconds East i.e. the object moves 1.0 arcseconds South and 1.0 arcseconds West on ARGUS.

7 Appendix

7.1 FLAMES Raw Data Spectral Format

The following figures give a schematic view of the spectral format for the different FLAMES fibre types on the raw images.

7.1.1 GIRAFFE - MEDUSA

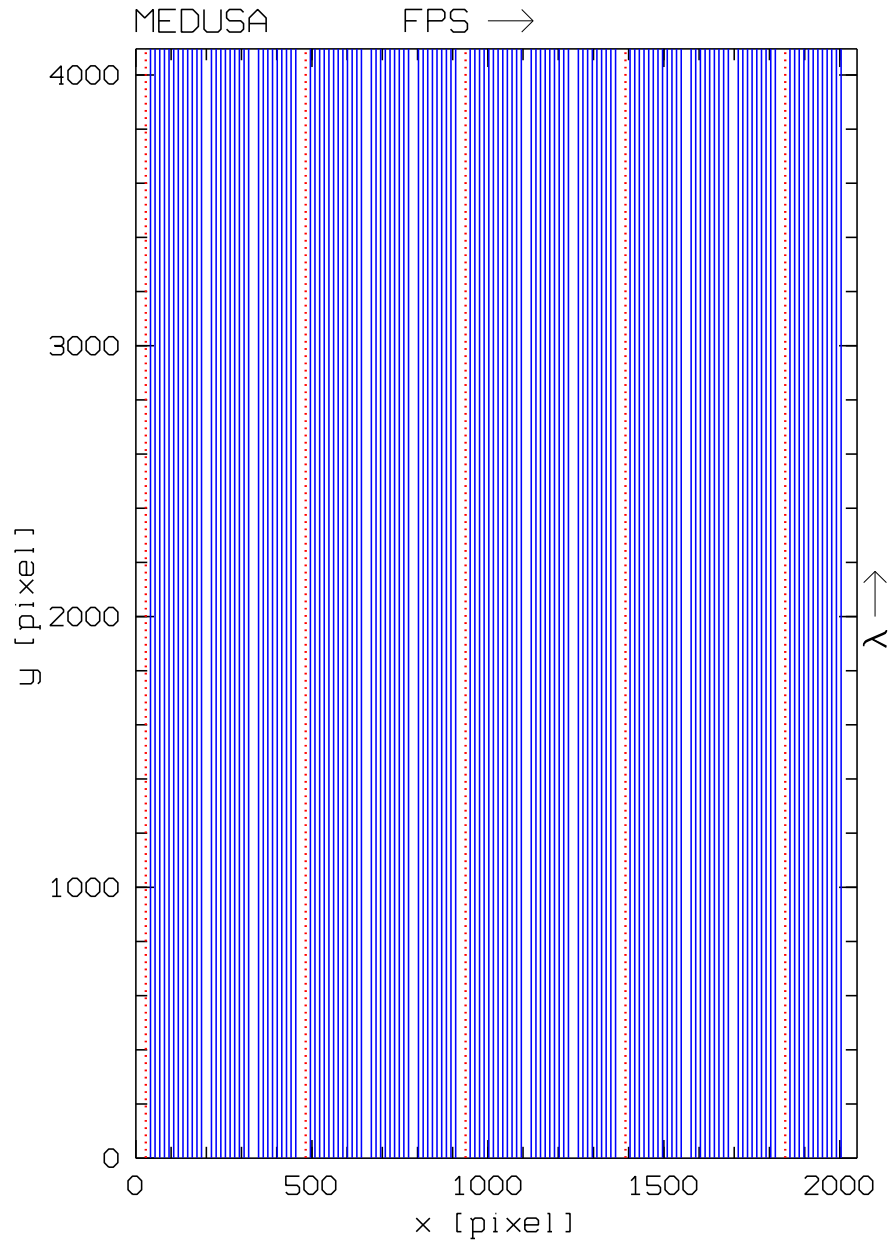
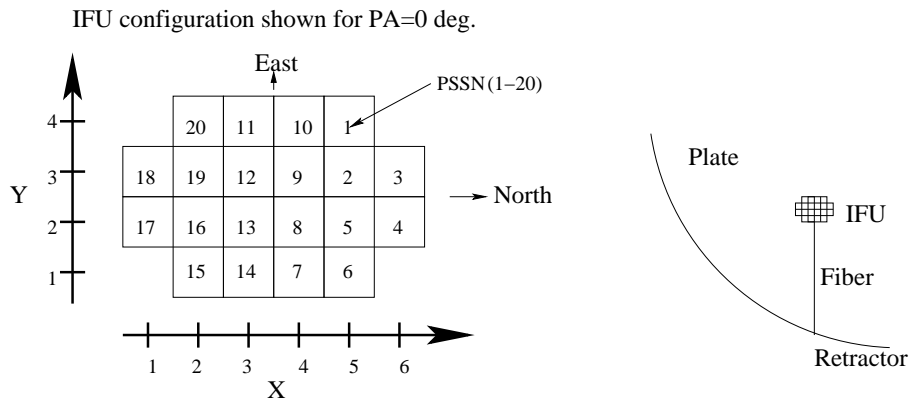

Figure 24: Schematic layout of the MEDUSA spectral format: blue solid lines: object fibres, red dots: calibration fibres. The direction of the increasing fibre number in the slit (FPS) and increasing wavelength λ are indicated.

7.1.2 GIRAFFE - IFU



- Notes: 1) Position Angle PA = 315 deg - ORIENT in binary OzPoz table. PA=North-East.
- 2) For IFUs with SKY fibers, the PSSN numbers should be increased by 1.
- 3) X,Y and PSSN can be found in the binary FLAMES FIBER table.

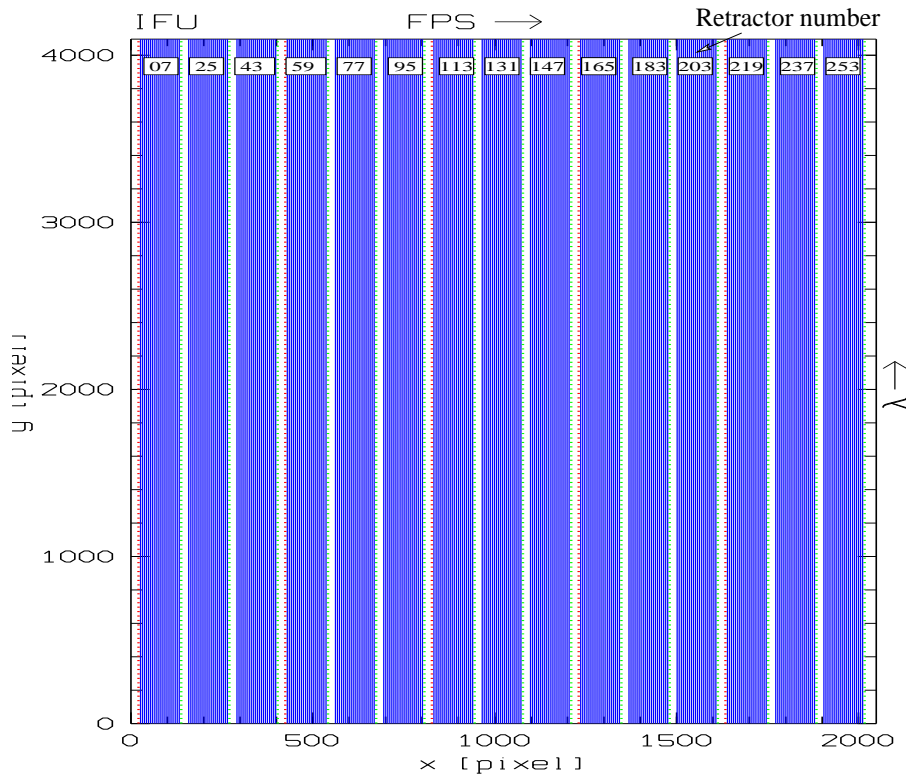

Figure 25: Top panel: Geometric layout of IFU fibers, including the X,Y and Position of the sub slits for an individual IFU. The IFU orientation (long/short axis) on the plate is also shown. Bottom panel: Schematic layout of the IFU spectral format (not to scale): blue solid lines: object fibres, red dots: calibration fibres, green dots: sky fibres. The direction of the increasing fibre number in the slit (FPS) and increasing wavelength λ are indicated, as well as the retractor number for each IFU.

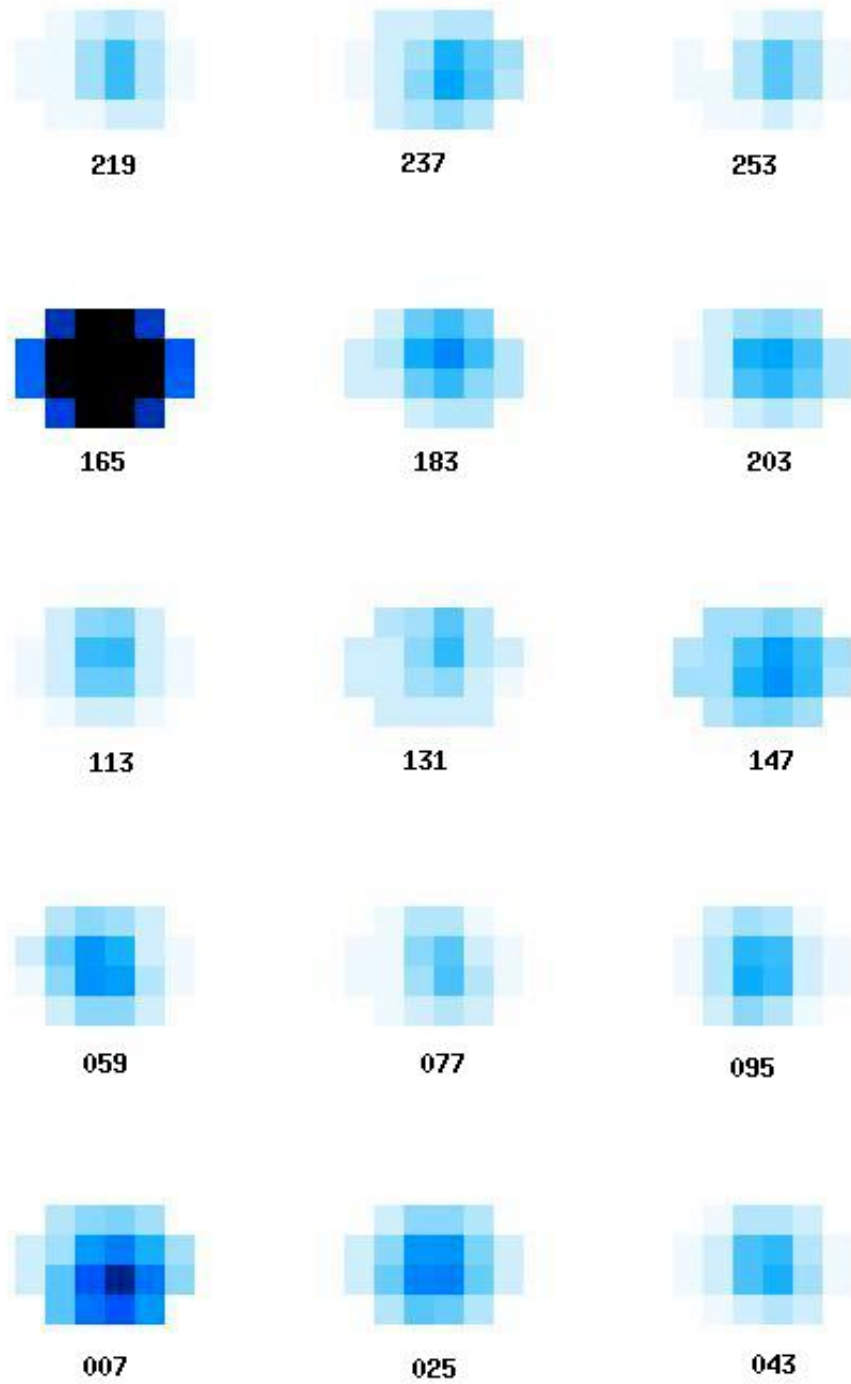

Figure 26: Reconstructed image of 15 IFU units produced by the pipeline.

7.1.3 GIRAFFE - ARGUS

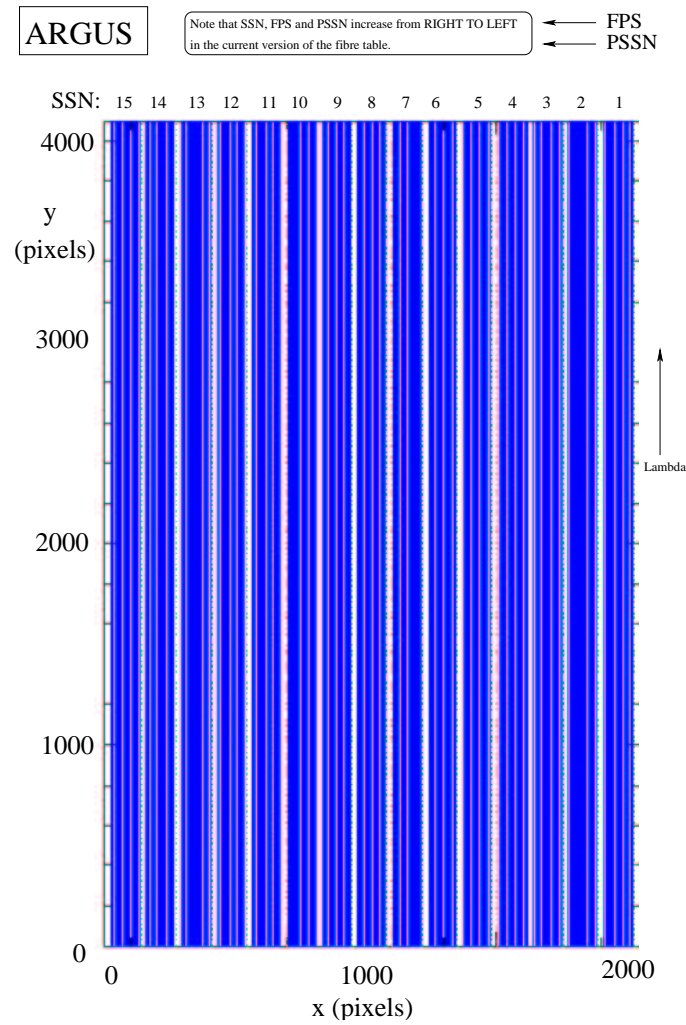

Figure 27: Schematic layout of the ARGUS spectral format: blue solid lines: object fibres, red dots: calibration fibres, green dots: sky fibres. The direction of the increasing fibre number in the slit (FPS) and increasing wavelength λ are indicated. Note that the directions of FPS, SSN and PSSN are inverted w.r.t. MEDUSA and IFU.

7.1.4 UVES - FIBRE

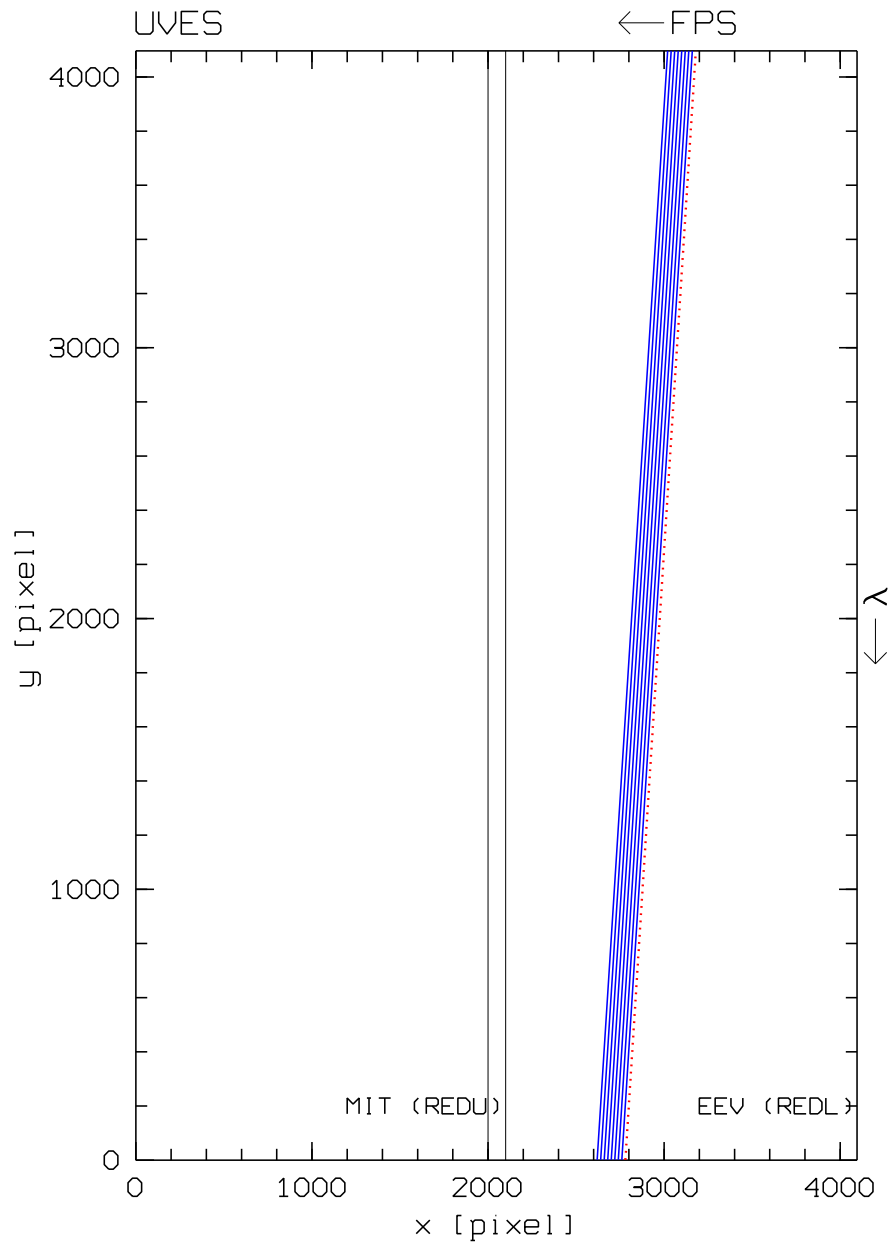

Figure 28: Schematic layout of the UVES – FIBRE spectral format for one order: blue solid lines: object fibres, red dots: calibration fibre. The direction of the increasing fibre number in the slit (FPS) and increasing wavelength λ are indicated. Redder echelle orders are to the left.

7.2 Characteristics of GIRAFFE Filters

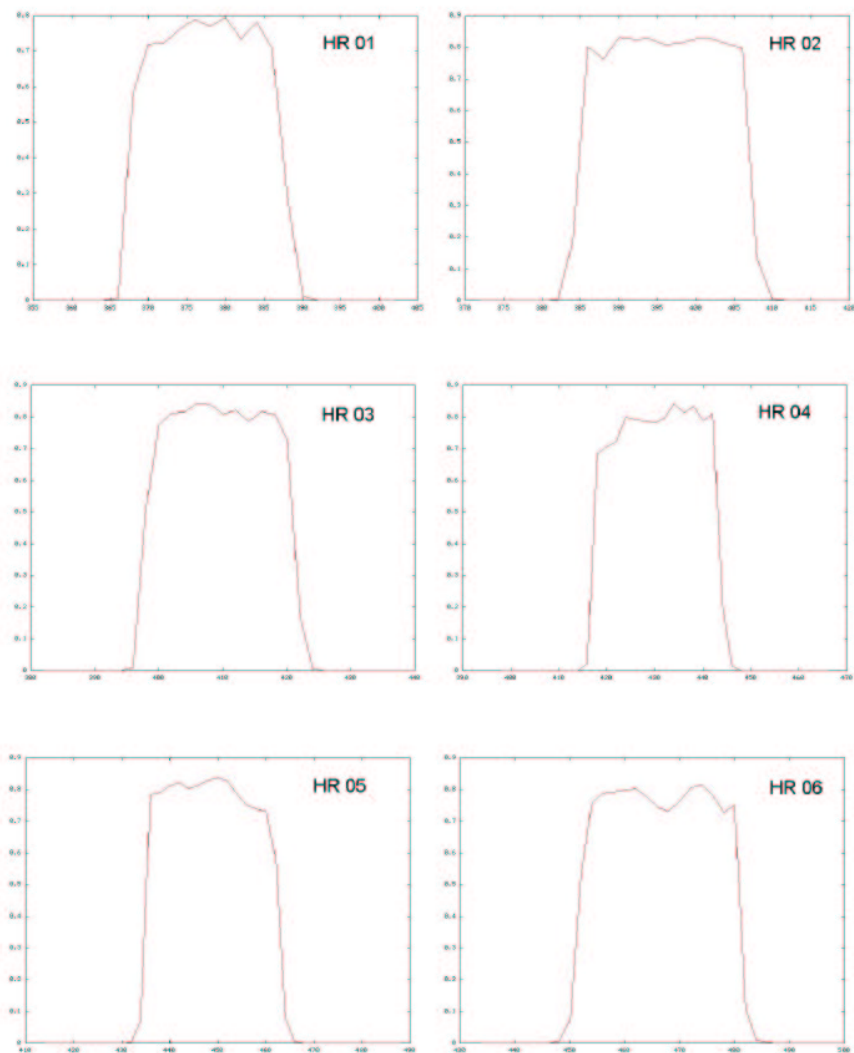

Figure 29: Transmission of the GIRAFFE High Resolution filters 01 – 06. Wavelength is in nm.

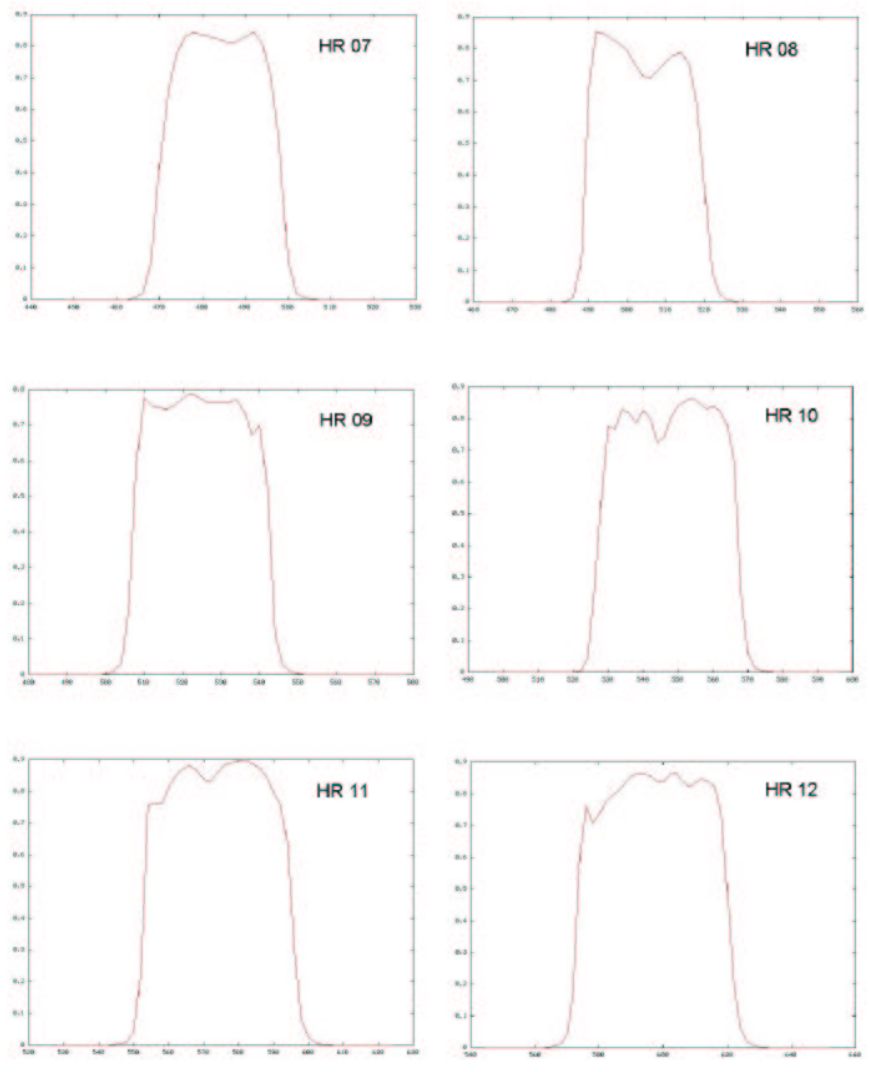

Figure 30: Transmission of the GIRAFFE High Resolution filters 07 – 12. Wavelength is in nm.

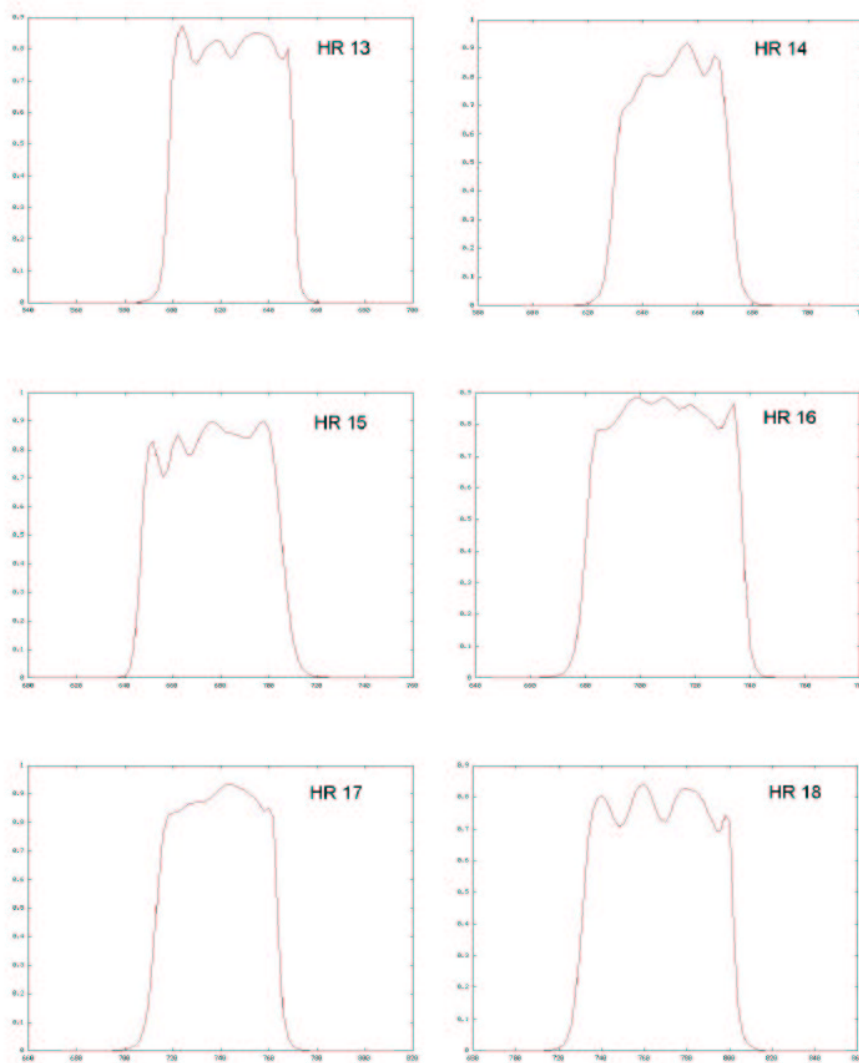

Figure 31: Transmission of the GIRAFFE High Resolution filters 13 – 18. Wavelength is in nm.

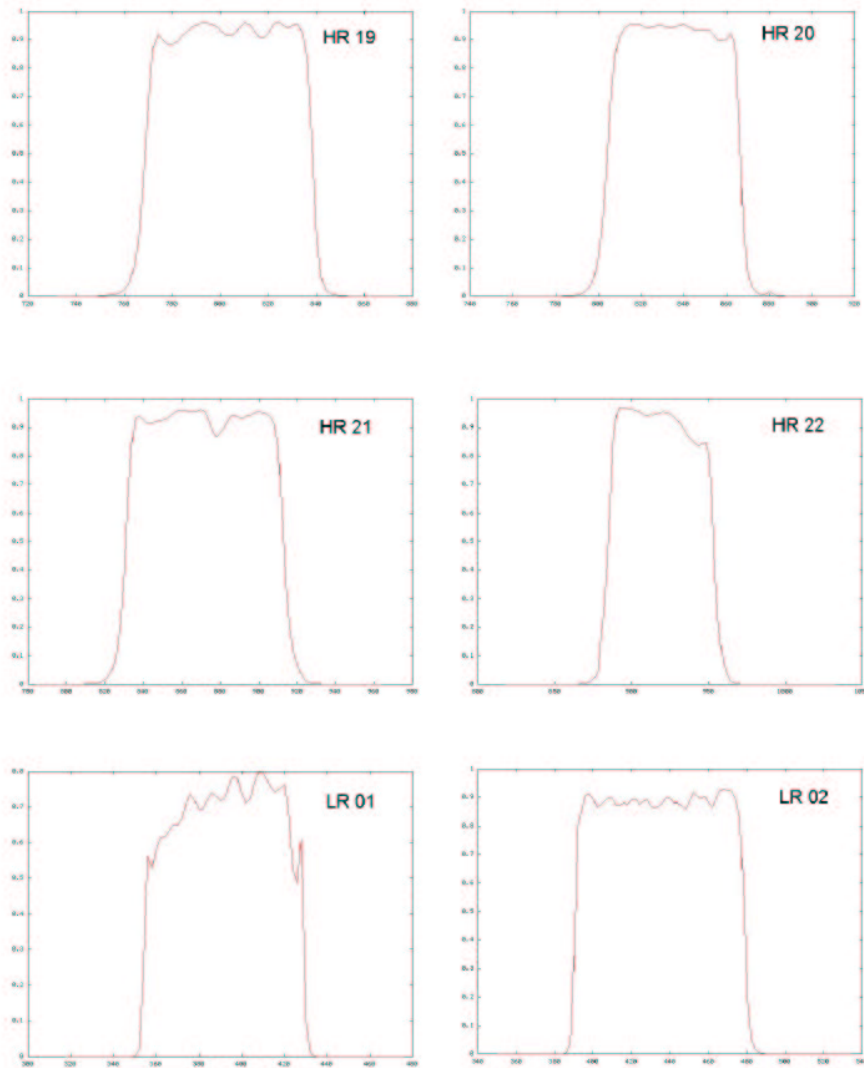

Figure 32: Transmission of the GIRAFFE High Resolution filters 19 – 22 and Low Resolution Filters 01 – 02. Wavelength is in nm.

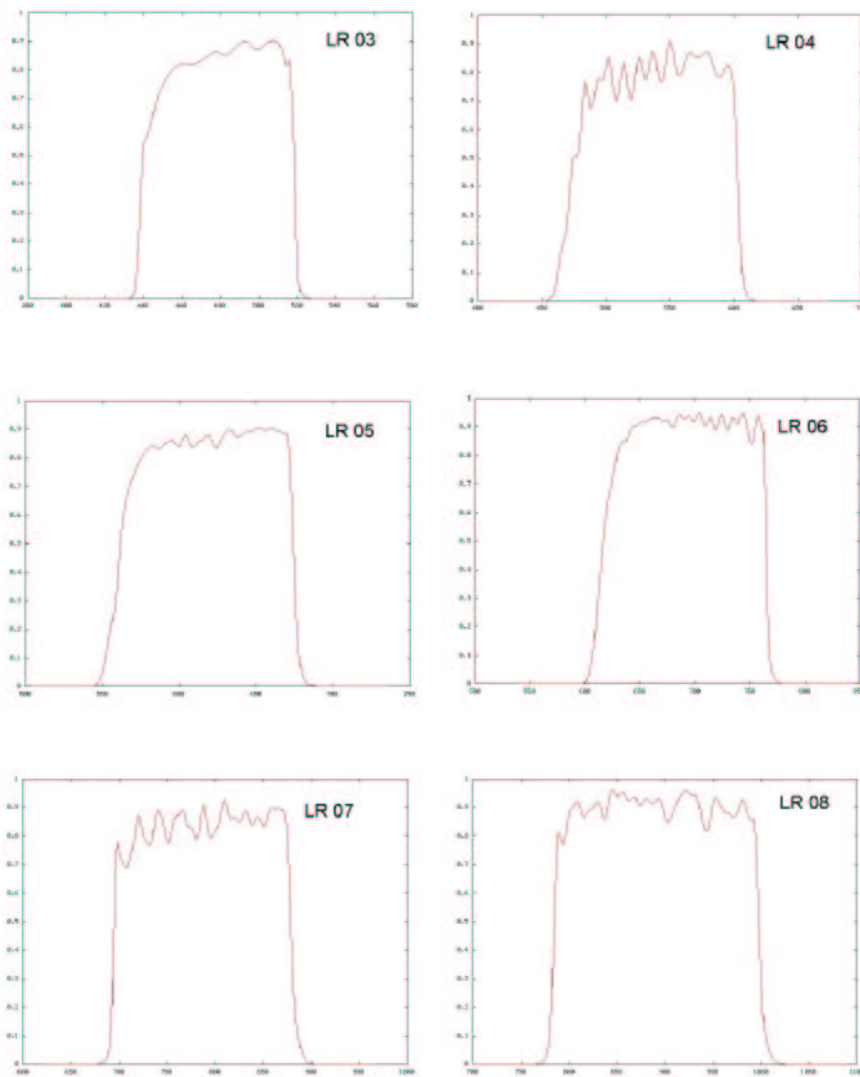

Figure 33: Transmission of the GIRAFFE Low Resolution filters 03 – 08. Wavelength is in nm.

7.3 FLAMES calibration times

Table 14 lists the calibrations times used for calibrating MEDUSA observations. Flat-field times are exposure time per frame. Typically, 3 frames are taken (more in the case of blue settings). IFU exposure times are twice the MEDUSA values. For ARGUS, the attached screen flat-field exposure times are twice the MEDUSA values. ARGUS calibrations using the robot are typically 4 times longer than the MEDUSA ones as the robot first needs to illuminate the sky fibers and then the ARGUS array. The quality of the ARGUS robot flats is not as good as for MEDUSA as the illumination of the array is not so uniform. For this reason screenflats are preferred for ARGUS, although in the blue the integration times required are very long.

7.4 Comparison between old and new HR gratings

In early October 2003, the high resolution grating on GIRAFFE was changed, leading to an increase in sensitivity at the loss of spectral resolutions in some setups. A comparison between old and new gratings is shown Table 15 below.

Mode	λ_{center} [nm]	ETC name	$t(\text{arc,robot})$ [sec]	$t(\text{FF,robot})$ [sec]	$t(\text{FF,screen})$ [sec]
MEDUSA	379.0	HR01	850	630	5384.0
MEDUSA	395.8	HR02	280	630	577.0
MEDUSA	412.4	HR03	270	630	566.0
MEDUSA	429.7	HR04	95	470	189.0
MEDUSA	447.1A	HR05A	455	420	144.0
MEDUSA	447.1B	HR05B	785	630	288.0
MEDUSA	465.6	HR06	280	315	98.0
MEDUSA	484.5A	HR07A	425	250	50.0
MEDUSA	484.5B	HR07B	565	250	140.0
MEDUSA	504.8	HR08	160	380	30.0
MEDUSA	525.8A	HR09A	710	240	60.0
MEDUSA	525.8B	HR09B	710	315	80.0
MEDUSA	548.8	HR10	220	190	25.0
MEDUSA	572.8	HR11	345	285	30.0
MEDUSA	599.3	HR12	235	190	14.0
MEDUSA	627.3	HR13	220	190	18.0
MEDUSA	651.5A	HR14A	815	140	10.0
MEDUSA	651.5B	HR14B	815	240	22.0
MEDUSA	665.0	HR15N	125	95	8.6
MEDUSA	679.7	HR15	125	125	8.3
MEDUSA	710.5	HR16	160	125	7.9
MEDUSA	737.0A	HR17A	110	60	7.9
MEDUSA	737.0B	HR17B	110	315	16.7
MEDUSA	769.1	HR18	140	60	5.0
MEDUSA	805.3A	HR19A	140	30	3.3
MEDUSA	805.3B	HR19B	300	60	4.6
MEDUSA	836.6A	HR20A	160	30	2.4
MEDUSA	836.6B	HR20B	160	110	11.8
MEDUSA	875.7	HR21	125	50	2.1
MEDUSA	920.5	HR22A	110	60	2.7
MEDUSA	920.5	HR22B	160	95	4.5
MEDUSA	385.7	LR01	330	630	300.0
MEDUSA	427.2	LR02	125	110	57.0
MEDUSA	479.7	LR03	125	60	40.0
MEDUSA	543.1	LR04	170	60	12.0
MEDUSA	614.2	LR05	125	60	7.5
MEDUSA	682.2	LR06	110	60	5.0
MEDUSA	773.4	LR07	30	30	2.1
MEDUSA	881.7	LR08	45	16	1.5
UVES 6FIB	520	–	80	30	80
UVES 7+1/8FIB	580	–	60	20	40
UVES 8FIB	860	–	60	20	40

Table 14: Integration times for ThAr arcs and W flats, for both Robot calibrations and attached Screen flats. IFU calibs (robot & screen) and ARGUS screen FF times are twice the MEDUSA values. ARGUS robot calibration times are 4 times the MEDUSA values (see § 5.2). Configuration time is excluded.

Fil. ¹	$\lambda_{\text{center}}^2$ [nm]	Order (old)	Order (new)	$\Delta\lambda$ [nm] (old)	$\Delta\lambda$ [nm] (new)	R^3 (old)	R^3 (new)	AvEff % ⁴ (old)	AvEff % ⁴ (new)
1	379.0	15	15	16.7	16.7	22 500	22 500	29.0	43.5
2	395.8	14	14	19.5	19.5	19 600	19 600	26.7	50.3
3	412.4	14	14	16.8	16.8	24 800	24 800	30.3	36.9
4	429.7	13	13	20.5	20.5	20 350	20 350	36.4	55.7
5	447.1	13	12	17.6	24.7	26 000	18 470	29.2	48.3
6	465.6	12	12	22.1	22.2	20 350	20 350	41.8	60.9
7	484.5	12	11	19.0	27.4	26 700	18 529	32.7	45.6
8	504.8	11	11	24.6	24.6	20 000	20 000	44.2	57.1
9	525.8	11	10	21.3	31.0	25 900	17 750	38.4	39.0
10	548.8	10	10	28.0	28.0	19 800	19 800	44.4	58.4
11	572.8	10	10	24.3	24.3	24 200	24 200	43.4	41.6
12	599.3	9	9	32.5	32.5	18 700	18 700	38.2	58.4
13	627.3	9	9	28.6	28.5	22 500	22 500	47.6	51.9
14	651.5	9	8	24.3	39.4	28 800	17 740	28.7	54.2
15	679.7	8	8	35.9	35.9	19 300	19 300	44.5	61.3
16	710.5	8	8	31.3	31.3	23 900	23 900	42.0	44.1
17	737.0	8	7	26.5	45.9	30 200	17 425	25.6	64.8
18	769.1	7	7	42.0	42.0	18 400	18 400	46.2	65.4
19	805.3	7	6	36.9	59.0	22 200	13 867	42.0	50.0
20	836.6	7	6	31.4	56.0	28 600	16 036	29.8	70.6
21	875.7	6	6	51.7	51.7	16 200	16 200	42.9	62.6
22	920.5	6	5	45.9	74.9	19 000	11 642	50.7	51.7

Table 15: Comparison between the GIRAFFE HR grating used pre and post-October 10 2003. 1 = The filter number; 2 = The central wavelength in nm; 3 = Resolving power R in MEDUSA mode for old and new HR gratings; 4 = Average efficiency for old and new HR gratings in percent.

— oOo —