

La Silla

European Southern Observatory

Organisation Européenne pour des Recherches Astronomiques dans l'Hémisphère Austral
Europäische Organisation für astronomische Forschung in der südlichen Hemisphäre

La Silla Observatory

High Accuracy Radial Velocity Planet Searcher

HARPS

User Manual

3P6-MAN-ESO-90100-0005

Issue: 2.3

Date: February 1st, 2019

La Silla Observatory ★ ESO ★ Chile

Change Record

Issue	date	sections affected	Reason/Remarks
0.1	February 2003	all	First version
0.2	March 5, 2003	all	for comments
0.3	March 10, 2003	all	first public issue for P72 CfP
0.4	June 16, 2003	all	GRU → DQU
0.5	July 8, 2003	all	DRS + end of Comm2/DQU
0.6	July 31, 2003	all	DAU info DSo
0.7	Sept 17, 2003	DRS related	data format +answer to comments
1.0	Nov 25, 2003	all	DQU
1.1	May 25, 2004	all	more information added and structure revised (GLC)
1.2	August 2005	Observing	full update (GLC)
1.3	May 2006	HARPS characteristics & EGGS	overheads and asteroseismology issues (GLC)
1.4	March 2007	all	include slow readout mode, THAR3 lamp and EGGS (GLC)
2.0	February 2010	Add polarimetry mode	Few improvements.
2.1	October 2011	several corrections & FP and LC template description (CME)	
2.2	August 2018	removing iodine cell observing mode & adding fibre exchange in 2015	several corrections
2.3	February 2019	adding laser frequency comb	several corrections

Editors: F. Rodler, G. Lo Curto (ESO La Silla)

Contents

1	Introduction	1
1.1	Scope	1
1.2	Additional information	1
1.3	Contact information	2
1.4	Acknowledgments	2
2	HARPS Characteristics and Subsystems	3
2.1	Instrument Overview	3
2.2	Operations overview	7
2.3	Fibre links	7
2.4	Fabry-Perot Calibration System	8
2.5	Laser Frequency Comb unit	8
2.6	Calibration unit	9
2.7	Fibre adapter	9
2.8	Detector and read-out electronics	9
2.9	Exposure meter	10
2.10	System efficiency	11
3	HARPS Observing Modes	13
3.1	Simultaneous reference method	13
3.1.1	Calibrations	14
3.1.2	Observations	15
3.1.3	Pipeline, data reduction	15
3.2	Classical fibre spectroscopy	16
3.2.1	Calibrations	16
3.2.2	Observations	16
3.2.3	Pipeline, data reduction	16
3.3	Polarimetry	17
3.3.1	The HARPS polarimeter	17
3.3.2	Performance	18
3.3.3	Calibrations	19
3.3.4	Observations	19
3.3.5	Pipeline, data reduction	19
3.4	HARPS high efficiency mode: EGGS	20
4	RV Precision	23
4.1	Photon noise	23
4.2	Telescope focus	24
4.3	Centering/defocusing errors	24
4.4	Thorium calibration errors	24
4.5	Laser Frequency Comb calibration errors	24

4.6	EGGS RV precision	24
4.7	2015 fibre exchange and its impact on RVs	24
5	Preparing the Observations	27
5.1	Visitor Mode and Delegated Visitor Mode	27
5.2	Requirements	27
5.3	Introducing Observing Blocks	27
5.4	P2PP	28
	5.4.1 Acquisition templates	28
	5.4.2 Observing templates	29
	5.4.3 Calibration templates	29
5.5	Overheads	30
	5.5.1 Execution time overheads	30
	5.5.2 “Off-line” overheads	30
	5.5.3 Fast time series observations (asteroseismology)	30
5.6	The HARPS Exposure Time and Spectral Format Calculator	31
6	Observing with HARPS	33
6.1	Before the night	33
6.2	During the night	33
	6.2.1 Target acquisition, guiding, focusing	33
	6.2.2 Pointing restrictions and weather limits	34
6.3	Night calibrations	35
6.4	Real-time display	35
6.5	Observing very faint stars	35
6.6	Asteroseismology	35
6.7	End of the night	37
7	The Reduction and Archiving of HARPS Data	39
7.1	The HARPS data reduction pipeline	39
	7.1.1 High accuracy radial velocities	40
	7.1.2 Iodine cell data (until 2004)	40
7.2	Data products and archiving	40
	7.2.1 Data products	40
	7.2.2 Data archiving	41
A	Description of Archived HARPS Data	43
A.1	Data naming rules	43
A.2	Data formats	43
	A.2.1 Raw frames	43
B	List of Acronyms	47

List of Figures

2.1	Optical layout of the spectrograph	4
2.2	Spectral format of HARPS. Blue orders are down, red are up.	5
2.3	Table showing the spectral format of HARPS and the expected number of electrons for a 1 minute exposure on a G2V star of magnitude 6. A seeing of 0.8", airmass = 1, and new moon are the values of the selected parameters. In the table the spectral bin is defined as one pixel. This table is obtained by the HARPS Exposure Time Calculator (ETC).	6
2.4	The main components of the HARPS system	8
2.5	Quantum efficiency of Jasmin	12
2.6	Quantum efficiency of Linda	12
3.1	Throughput of HARPS with and without the polarimeter, for both the linear and the circular polarimeter.	17
3.2	Polarized line profiles of the star γ Equus	18
3.3	Line profiles of α Centauri in the three Stokes parameters.	19
3.4	HAM - EGGS comparison	20
6.1	The sky area accessible for HARPS	34
6.2	HARPS spectrum in the RTD	36
A.1	Raw frame format.	45

List of Tables

2.1	Level of diffuse + stray light and ghosts as a percent of the flux in the order.	5
2.2	Characteristic optical data of HARPS	7
2.3	Exposure meter count rates	11
2.4	Overall efficiency of the HARPS system. See text.	11
3.1	Comparison of the HAM and EGGS performances.	21
5.1	Fiber illumination scheme for each template.	28
5.2	Execution times overheads	30
5.3	“Off-line” overheads	30

Chapter 1

Introduction

1.1 Scope

This User Manual is intended to give all necessary information to potential users of the HARPS instrument, to help them decide on the opportunity to use the instrument for their scientific applications, to be used as a reference when writing observing proposals and when preparing the observations.

For this purpose we give

- an overall description of the HARPS instrument, its performance and its observing modes;
- information on the preparation of the observations;
- information on the observing process;
- a description of the HARPS data and near real-time pipeline data reduction.

The following documents are closely related to this manual and should be consulted as well:

- the P2 / P2PP User Manual
- the HARPS Template Guide

Both are available through the “Information Sources” section of the HARPS web pages

<http://www.eso.org/sci/facilities/lasilla/instruments/harps/doc/index.html>.

1.2 Additional information

The latest information updates about the HARPS instrument can be found on the HARPS web pages

<http://www.eso.org/sci/facilities/lasilla/instruments/harps/index.html>.

General information about observing at La Silla is available from the La Silla web pages

<http://www.eso.org/sci/facilities/lasilla.html>

1.3 Contact information

In case of specific questions related to observations and proposal preparation, please contact the HARPS Operations team:

`ls-harps@eso.org`.

1.4 Acknowledgments

Most of the contents of this manual is based on information from the HARPS Consortium (Observatoire de Genève, Observatoire de Haute Provence, Universität Bern, Service d'Aéronomie, ESO La Silla and Garching), in particular by F. Pepe and D. Queloz, and from La Silla Science Operations (G. Lo Curto and T. Dall). Releases of this documents are based on the original version edited by Gero Rupprecht.

Feedback on this User Manual from users is encouraged. Please email to `ls-harps@eso.org`.

Chapter 2

HARPS Characteristics and Subsystems

2.1 Instrument Overview

HARPS (High-Accuracy Radial-velocity Planetary Searcher) is an instrument designed for the measurement of Radial Velocities (RV) at highest accuracy. It was built by the HARPS Consortium consisting of Observatoire de Genève, Observatoire de Haute Provence, Physikalisches Institut der Universität Bern, Service d'Aéronomie du CNRS and with substantial contribution from ESO-La Silla and ESO-Garching. Its purpose is to reach a long term radial velocity accuracy of 1 m/s for slowly rotating G-dwarfs. Such precision enables the detection of low mass (Saturn like) extra-solar planets and low amplitude stellar oscillations.

The design of HARPS is based on the experience acquired with ELODIE (installed at the 1.93m telescope at OHP) and CORALIE (at the 1.2m Swiss Euler telescope at La Silla) by the members of the HARPS Consortium. The basic design of HARPS is therefore very similar to these instruments. The efforts to increase the HARPS performance compared to its predecessors address mainly three issues:

- Increase of the instrumental stability: The spectrograph is installed in an evacuated and temperature-controlled vacuum enclosure. This allows to remove, to a very large extent, all RV drifts which would be produced by temperature variations or changes in ambient air pressure and humidity.
- Increase of the signal-to-noise ratio (S/N) on single RV measurements: The improvement is attained through different steps. First, HARPS is installed on the ESO 3.6-m telescope. Second, the spectral resolution is increased by a factor of about two. The higher spectral resolution helps also to reduce instrumental errors. Third, the spectrograph optics, which is very similar to that of UVES, is very efficient.
- Improvement of the online data reduction: includes better corrections for instrumental effects and zero point definition (wavelength calibration) and it is substantially faster.

HARPS is a fibre-fed, cross-dispersed echelle spectrograph located in the Coude' floor of the 3.6m telescope. For the sake of thermal and mechanical stability the spectrograph is enclosed in a vacuum vessel evacuated to a pressure $< 10^{-2}$ mbar and maintained to a temperature of 17° C, constant within 0.005° C RMS. No moving parts are located inside the vacuum vessel (VV). The spectrograph itself has only one possible mechanical configuration. All necessary moving parts are located in the

Harps Cassegrain Fibre Adapter (HCFA), with the exception of the shutter, which is located just outside of the vacuum vessel. The optical design, shown in Figure 2.1, is similar to UVES at the VLT.

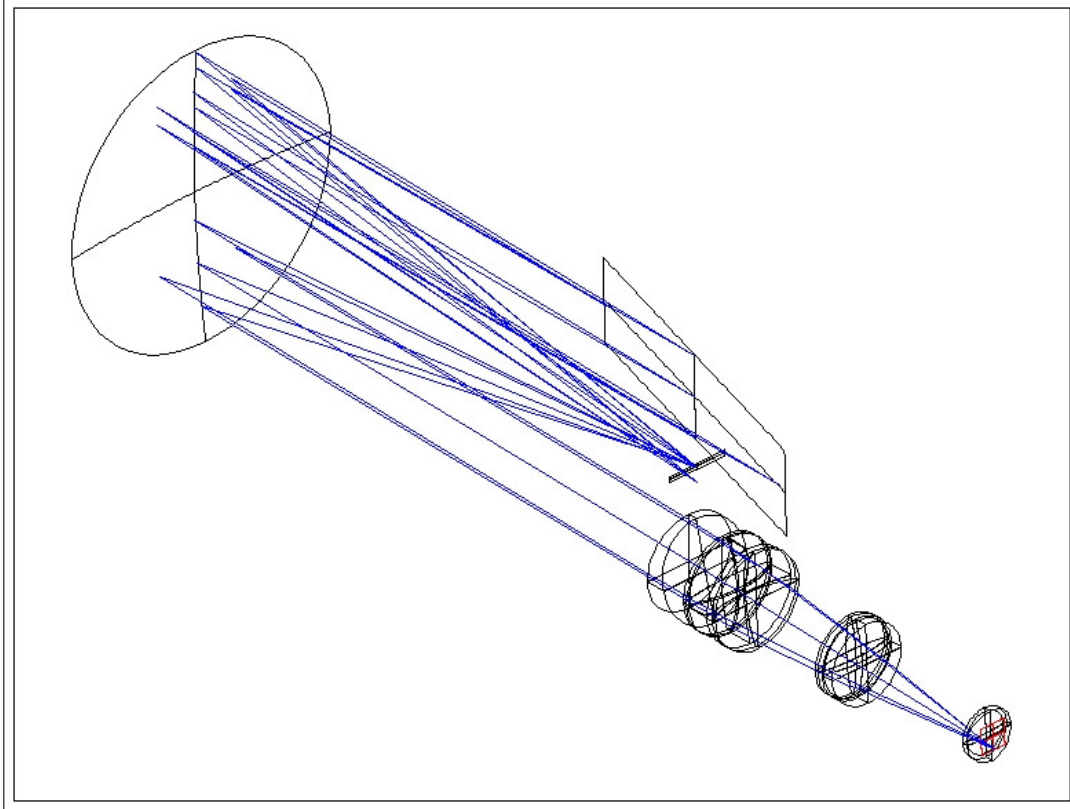

Figure 2.1: Optical layout of the spectrograph

Its echelle grating is operated in quasi-Littrow conditions (off plane angle = 0.721 deg blaze angle) and the collimator in triple pass mode. A white pupil configuration has been adopted with the cross disperser placed at the white pupil. The dioptric camera images the cross-dispersed spectrum on a detector mosaic of two CCDs. Two fibres (A and B) feed the spectrograph, one object fibre and one reference fibre (science fibres). The spectra of the light from both fibres are formed by the spectrograph side by side on the detector.

Although all care has been taken to avoid stray light and ghosts, both are present at some level, most noticeably in the blue part of the spectrum (Table 2.1). Ghosts seems to be due to third order reflections in the grism.

The instrument is coupled to the telescope through an adapter: the HARPS Cassegrain Fiber Adapter (HCFA). Two calibration fibers transmit the light from the calibration unit located in the Coude' floor to the HCFA and inject it in the two science fibers for calibration.

The characteristic optical data are given in Table 2.2.

The spectral format is shown in Fig. 2.2.

Since the beginning of Period 78 a high-efficiency mode (called EGGS) is offered for HARPS. In this mode, the photon collecting efficiency is increased by a factor up to two (depending on the seeing) at the expense of Radial Velocity accuracy. The new mode is useful for faint objects for which a radial velocity accuracy of no better than 3 m/s is required. The characteristics of this mode and its operation are described in Section 3.4

Halogen lamp (3000 K)			
Order n.	Wavelength (nm)	Diffused + stray light	Ghosts
90	680	0.2%	0.05%
116	527	0.4%	0.5%
160	383	≈ 1%	2%

G3V star (5700 K)			
Order n.	Wavelength (nm)	Diffused + stray light	Ghosts
90	680	0.2%	< 0.2%
116	527	0.3%	0.2%
160	383	< 1%	< 4%

Table 2.1: Level of diffuse + stray light and ghosts as a percent of the flux in the order.

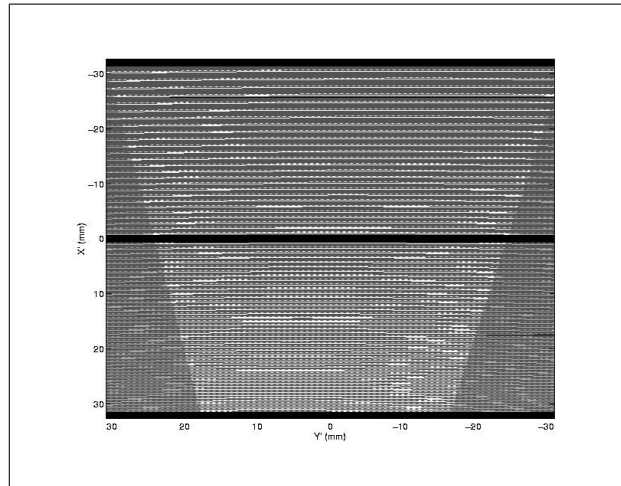

Figure 2.2: Spectral format of HARPS. Blue orders are down, red are up.

Since the beginning of Period 86 a polarimeter is available on HARPS. The unit is able to perform both circular and linear polarimetry. Measurements of the throughput show a light loss with respect to the standard mode of HARPS in the range of 20% to 30%, increasing to $\approx 40\%$ in the bluest orders. The instrumental polarization was not detected down to a level of 10^{-4} for zenith angles smaller than 60 degrees. Closer to the horizon the instrumental polarization grows rapidly if the Atmospheric Dispersion Corrector is in the light beam. Also the polarimetric data of HARPS are reduced by the online pipeline.

As from P89, a Fabry-Perot etalon is available as a comparison source on HARPS as an alternative to the ThAr lamp. The performance of the etalon is described in Wildi et al. (2011, SPIE, 8151; http://obswww.unige.ch/~wildif/publications/2011_8151-51.pdf) and show that **the Fabry-Perot provides a better drift estimate in comparison to the ThAr lamp 2** (see Sect 2.4).

As from P102, a Laser Frequency Comb (LFC) is available as an absolute wavelength standard, as an alternative to the ThAr1 lamps. The performance of the LFC is described in Lo Curto et al. (2012), ESO Messenger 149, 2L and references therein (see Sect 2.5).

In the following is presented a brief description of the HARPS components: the fibre adapter on the telescope, the calibration unit, and the fibre links connecting these components. A sophisticated online data reduction pipeline is also part of the system (section 8). The hardware part of the system is schematically illustrated in Fig. 2.4.

Order	Wavelength of central column						
	lambda (nm)	bin size (nm)	Eff. %	Obj e-	Sky e-	Imax e-	S/N per spectral bin
89	687.76	0.0019	3.1	1.42e+04	0.01	5.1e+03	1.2e+02
90	680.12	0.0019	3.2	1.47e+04	0.0103	5.3e+03	1.2e+02
91	672.65	0.0018	3.4	1.53e+04	0.0106	5.6e+03	1.2e+02
92	665.34	0.0018	3.6	1.6e+04	0.0108	5.8e+03	1.3e+02
93	658.19	0.0018	3.7	1.63e+04	0.011	5.9e+03	1.3e+02
94	651.19	0.0018	3.8	1.7e+04	0.0111	6.2e+03	1.3e+02
95	644.34	0.0018	4	1.74e+04	0.0113	6.3e+03	1.3e+02
96	637.63	0.0017	4.1	1.78e+04	0.0114	6.5e+03	1.3e+02
97	631.06	0.0017	4.2	1.76e+04	0.0114	6.4e+03	1.3e+02
98	624.62	0.0017	4.2	1.77e+04	0.0113	6.4e+03	1.3e+02
99	618.31	0.0017	4.3	1.82e+04	0.0112	6.6e+03	1.3e+02
100	612.13	0.0017	4.4	1.82e+04	0.0113	6.6e+03	1.3e+02
101	606.07	0.0017	4.5	1.86e+04	0.0112	6.8e+03	1.4e+02
102	600.13	0.0016	4.5	1.83e+04	0.0111	6.6e+03	1.3e+02
103	594.31	0.0016	4.5	1.85e+04	0.0109	6.7e+03	1.4e+02
104	588.59	0.0016	4.5	1.69e+04	0.0107	6.1e+03	1.3e+02
105	582.99	0.0016	4.6	1.91e+04	0.0108	6.9e+03	1.4e+02
106	577.49	0.0016	4.7	1.91e+04	0.0108	6.9e+03	1.4e+02
107	572.09	0.0016	4.7	1.9e+04	0.0106	6.9e+03	1.4e+02
108	566.80	0.0015	4.7	1.82e+04	0.0104	6.6e+03	1.3e+02
109	561.60	0.0015	4.8	1.78e+04	0.0103	6.5e+03	1.3e+02
110	556.50	0.0015	4.7	1.8e+04	0.0101	6.5e+03	1.3e+02
111	551.48	0.0015	4.7	1.75e+04	0.0098	6.3e+03	1.3e+02
112	546.56	0.0015	4.7	1.73e+04	0.00955	6.3e+03	1.3e+02
113	541.73	0.0015	4.6	1.69e+04	0.00933	6.1e+03	1.3e+02
114	536.97	0.0015	4.6	1.63e+04	0.00909	5.9e+03	1.3e+02
116	527.73	0.0014	4.5	1.5e+04	0.0068	5.4e+03	1.2e+02
117	523.22	0.0014	4.4	1.47e+04	0.00664	5.3e+03	1.2e+02
118	518.78	0.0014	4.4	1.34e+04	0.00648	4.9e+03	1.2e+02
119	514.43	0.0014	4.4	1.39e+04	0.00631	5e+03	1.2e+02
120	510.14	0.0014	4.3	1.4e+04	0.00613	5.1e+03	1.2e+02
121	505.92	0.0014	4.3	1.41e+04	0.00595	5.1e+03	1.2e+02
122	501.78	0.0014	4.2	1.29e+04	0.00579	4.7e+03	1.1e+02
123	497.70	0.0014	4.2	1.32e+04	0.00564	4.8e+03	1.1e+02
124	493.69	0.0013	4.1	1.31e+04	0.0055	4.7e+03	1.1e+02
125	489.74	0.0013	4.1	1.31e+04	0.00536	4.7e+03	1.1e+02
126	485.85	0.0013	4	1.09e+04	0.00521	4e+03	1e+02
127	482.03	0.0013	4	1.25e+04	0.00505	4.5e+03	1.1e+02
128	478.26	0.0013	3.9	1.23e+04	0.00492	4.5e+03	1.1e+02
129	474.56	0.0013	4	1.21e+04	0.00488	4.4e+03	1.1e+02
130	470.91	0.0013	4	1.14e+04	0.00486	4.1e+03	1.1e+02
131	467.31	0.0013	4	1.14e+04	0.0048	4.1e+03	1.1e+02
132	463.77	0.0013	4	1.16e+04	0.0047	4.2e+03	1.1e+02
133	460.29	0.0013	4	1.12e+04	0.00458	4.1e+03	1.1e+02
134	456.85	0.0012	3.9	1.12e+04	0.00446	4.1e+03	1.1e+02
135	453.47	0.0012	3.9	9.9e+03	0.00435	3.6e+03	99
136	450.14	0.0012	3.8	1.09e+04	0.00424	4e+03	1e+02
137	446.85	0.0012	3.8	9.75e+03	0.00415	3.5e+03	98
138	443.61	0.0012	3.8	9.58e+03	0.00407	3.5e+03	97
139	440.42	0.0012	3.8	8.72e+03	0.004	3.2e+03	93
140	437.28	0.0012	3.7	8.53e+03	0.0039	3.1e+03	92
141	434.18	0.0012	3.7	7.43e+03	0.00378	2.7e+03	85
142	431.12	0.0012	3.6	6.66e+03	0.00365	2.4e+03	81
143	428.11	0.0012	3.5	6.92e+03	0.0035	2.5e+03	82
144	425.13	0.0012	3.4	6.72e+03	0.00333	2.4e+03	81
145	422.20	0.0012	3.2	6.38e+03	0.00315	2.3e+03	79
146	419.31	0.0011	3.1	6.22e+03	0.00298	2.3e+03	78
147	416.46	0.0011	3	6.23e+03	0.00292	2.3e+03	78
148	413.65	0.0011	2.9	5.82e+03	0.00268	2.1e+03	75
149	410.87	0.0011	2.8	5.11e+03	0.00254	1.9e+03	70
150	408.13	0.0011	2.6	5.17e+03	0.0024	1.9e+03	71
151	405.43	0.0011	2.5	4.62e+03	0.00225	1.7e+03	67
152	402.76	0.0011	2.4	4.41e+03	0.0021	1.6e+03	65
153	400.13	0.0011	2.2	3.94e+03	0.00196	1.4e+03	62
154	397.53	0.0011	2.1	3.02e+03	0.00181	1.1e+03	54
155	394.97	0.0011	2	2.26e+03	0.00166	8.2e+02	46
156	392.44	0.0011	1.8	2.12e+03	0.00152	7.7e+02	45
157	389.94	0.0011	1.7	2e+03	0.00139	7.3e+02	43
158	387.47	0.0011	1.5	1.66e+03	0.00127	6e+02	39
159	385.03	0.001	1.4	1.5e+03	0.00115	5.4e+02	37
160	382.63	0.001	1.3	927	0.00104	3.4e+02	28
161	380.25	0.001	1.2	1.37e+03	0.000938	5e+02	35

Figure 2.3: Table showing the spectral format of HARPS and the expected number of electrons for a 1 minute exposure on a G2V star of magnitude 6. A seeing of 0.8", airmass = 1, and new moon are the values of the selected parameters. In the table the spectral bin is defined as one pixel. This table is obtained by the HARPS Exposure Time Calculator (ETC).

Item	description
System	4 fibres (two pairs, one pair with 1" diameter on sky and the other pair with 1.4", distance each 114"), spectral range 380-690nm, collimated beam diameter 208mm
Echelle grating	R4, 31.6 gr/mm blaze angle 75°, mosaic 2×1 on Zerodur monolith 840 × 214 × 125mm, efficiency > 65% in the visible
Cross disperser grism	FK5 grism, 257.17 gr/mm blazed at 480nm, 240 × 230 × 50mm, T=73% (average)
Collimator mirror	Zerodur with protected silver coating, f=1560mm, used diameter 730mm, triple pass
Camera	all dioptric, 6 elements in 3 groups, f=728mm, f/3.3, T>85%
Detector	2 2k × 4k EEV CCDs, pixel size 15 ² μm ²
Beam focal ratio	inside the spectrograph: 7.5
Spectral format	"upper, red" CCD (Jasmin): orders 89-114, 533-691 nm "lower, blue" CCD (Linda): orders 116-161, 378-530 nm
Spectral resolution	RS=115,000 (measured)
Sampling per spectral element	3.4 px per FWHM
Spectrum Separation	17.3 px (fibres A and B)
Order separation Jasmin	order 89: 1.510mm = 100.7px, order 114: 0.940mm = 62.7px
Order separation Linda	order 116: 0.910mm = 60.7px, order 161: 0.513mm = 34.2px
Spectrograph stability	±1 m/s in one night under normal conditions

Table 2.2: Characteristic optical data of HARPS

2.2 Operations overview

The HARPS instrument is mounted on the Cassegrain focus of the 3.6m telescope in La Silla. It is fed by two fiber types, HAM and EGGS, permanently mounted in the HCFA (see below). The High RV Accuracy Mode uses a narrow fibre called HAM for getting the best RV accuracy possible whereas in the High Efficiency Mode uses a wider fibre called EGGS for a better throughput at expenses of the RV accuracy (see Chapter 3.4) Users can switch from HAM to EGGS and vice versa anytime during night. This operations requires the redefinition of the centering pixel in the guiding camera of the telescope by the operator. It is a simple procedure which takes no more than 2 minutes.

2.3 Fibre links

The spectrograph is linked to the 3.6m telescope via two optical fibres. The fibre link incorporates an image scrambler which is fixed on the vacuum vessel and contributes to stabilize the input point spread function (PSF) of the spectrograph. The scrambler serves also as vacuum feed-through for the fibres and in addition houses the exposure shutter. The shortest useful exposure time supported by the shutter is 0.2 seconds.

A second fibre link connects the Calibration Unit (CU, section 2.6) next to the spectrograph with the HARPS Cassegrain Fibre Adapter (HCFA) on the telescope (see Figure 2.1).

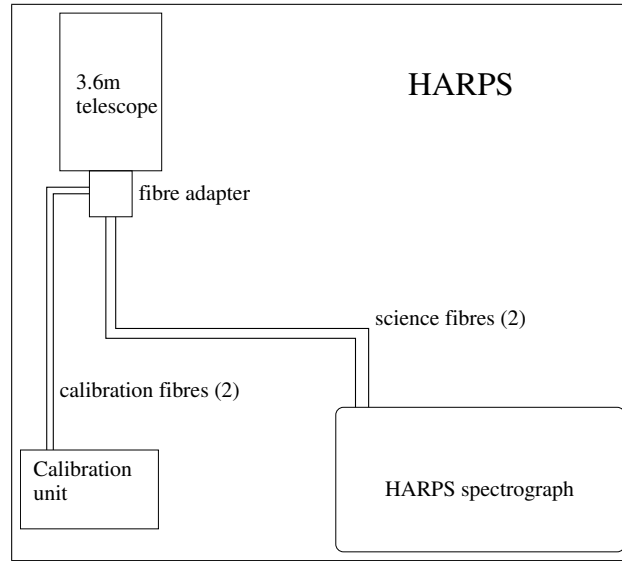

Figure 2.4: The main components of the HARPS system

2.4 Fabry-Perot Calibration System

The Fabry-Perot is the standard calibration source for the simultaneous reference method. It offers many advantages over the ThAr lamp:

- photon precision on a single frame better than the ThAr, down to 5 cm s^{-1} ,
- nightly stability of better than the specified 10 cm s^{-1} ,
- a clean and uniform spectrum with along the entire spectral range of HARPS with a high and uniform spectral lines density.

In addition, the FP can be effectively used on short exposure times below 20 s whereas the ThAr lamp requires an exposure time larger than 40 s to have a negligible photon-noise.

2.5 Laser Frequency Comb unit

HARPS is the first astronomical spectrograph routinely employing a Laser Frequency Comb (LFC) calibration system (aside the solar spectrograph installed at VTT). The LFC provides a set of equally spaced, unresolved lines, covering the wavelength range from 516 nm to 690 nm. Their positions are bound via a GPS system to a Cesium atomic clock, effectively linking them to the definition of the unit of time.

A short term precision consistent with photon noise down to the level of 1 cm/s has been demonstrated after co-adding several spectra to beat down photon noise. For a description of this system and its performances we refer to Lo Curto et al. (2012), ESO Messenger 149, 2L, and references therein.

We offer the LFC for wavelength calibration only, but not to measure the nightly instrumental drift via the simultaneous reference method (the Fabry-Perot should be used instead).

2.6 Calibration unit

The Calibration Unit (CU) contains one Tungsten flat-field lamp for flatfielding and two identical Thorium-Argon lamps for spectral calibration.

The CU receives the light delivered via optical fibers from a Fabry-Perot (FP) etalon and a Laser Frequency Comb (LFC) unit. It is connected via two optical fibres to the Harps Cassegrain Fibre Adapter (HCFA) which redirects the light of the calibration sources into the spectrograph fibres. The two calibration fibres can be fed either by the same or independently by two different calibration sources.

Of the two Thorium-Argon lamps, the lamp dubbed ‘THAR1’ is the absolute reference and should be used only for the afternoon calibrations and then be switched off. Ideally this should prolong the life time of this reference lamp.

Table 5.1 illustrates the fiber illumination scheme as a function of the template used.

2.7 Fibre adapter

All optical fibres are connected to the HCFA which forms the interface to the telescope. The HCFA provides several functions:

1. Illumination of the object and the reference fibres; each can be separately fed by the object, the sky, light from a calibration source, or it can be dark.
2. Correction of atmospheric dispersion by means of an ADC.
3. Switching between HARPS and EGGS fibres.
4. Feeding of the fibre viewer technical CCD camera for guiding.
5. Introduction of the linear / circular polarimeter in the beam path (if relevant).
6. Attenuating the reference light beam from the ThAr lamp via a neutral density wheel to an equivalent exposure time of 40 s at zero density. This can be done for exposure times from 40 s to 5400 s.

2.8 Detector and read-out electronics

The detector is a mosaic of two 2k×4k EEV CCDs. It is mounted in a ESO detector head and cooled to 148K by means of an ESO continuous flow cryostat (CFC). The detector is controlled by the standard ESO CCD controller FIERA. The detector head is mounted on the optical bench while the CFC is fixed on the outer wall of the vacuum vessel. They are linked by a specially developed mechanical interface which is damping the CFC vibration.

Each of the two CCDs has 50 pre-scan and 50 over-scan columns (A.1).

The two CCDs are read by two different amplifiers and a difference of up to 10% in the bias level of the two CCDs might be expected. Following we present the CCD test results as they were obtained on the test bench in Garching, before installation at the telescope. Note that the 50 kpx/s read out mode is not available.

Property	Jasmin (red)	Linda (blue)
CTE vertical (50 kpx/s)	0.-999992	0.-9999991
CTE horizontal (50 kpx/s)	0.-999991	0.-9999990
CTE vertical (416 kpx/s)	0.-9999997	0.-99999991
CTE horizontal (416 kpx/s)	0.-9999995	0.-9999990
Non-linearity	not available	$< \pm 0.298\%$
Read out noise (50 kpx/sec)	$2.87 \pm 0.1 e^-$	$2.76 \pm 0.09 e^-$
Read out noise (416 kpx/sec)	$7.05 \pm 0.23e^-$	$5.5 \pm 0.16 e^-$
Conversion factor (50 kpx/sec)	$0.63 \pm 0.02e^-/\text{ADU}$	$0.62 \pm 0.02 e^-/\text{ADU}$
Conversion factor (416 kpx/sec)	$1.42 \pm 0.04e^-/\text{ADU}$	$1.4 \pm 0.04 e^-/\text{ADU}$
Dark current at -110°C	not measured	not measured
Quantum efficiency	peak 82% at 440 nm	peak 85% at 460 nm
Cosmetics	science grade (grade 1)	science grade (grade 1)

Readout time (4296×4096 px)	50 kpx/s: 180s, 416 kpx/s: 23 s
Mosaic flatness (peak-to-peak)	$15 \mu\text{m}$
CCD parallelism	12'
Chip to chip gap	$1215 \pm 45 \mu\text{m}$

The two CCDs are nicknamed ‘‘Jasmin’’ (the ‘‘red’’ CCD) and ‘‘Linda’’ (the ‘‘blue’’ one). Their quantum efficiencies are given in Figures 2.5 and 2.6, respectively.

Two read out modes are offered, one with a high-gain, low-noise, mode with a readout speed of 104 kpix/s, and a faster read out mode at a speed of 416 kpix/s. The characteristics of these two modes available for scientific purposes are listed in the following table:

Property	Jasmin (red, # 78)	Linda (blue, # 77)
Read out noise 104 kpix/s (e^-)	3.0	2.8
Read out noise 416 kpix/s (e^-)	4.5	4.8
Gain 104 kpix/s (ADU/e^-)	2.04	2.04
Gain 416 kpix/s (ADU/e^-)	0.74	0.76
Bias 104 kpix/s (ADU)	198	196
Bias 416 kpix/s (ADU)	186	248

The read out time (4296×4096 pixels) is of 87 s and 23 s for the 104 kpix/s and the 416 kpix/s modes respectively. The 104 kpix/s read out mode, or ‘‘slow’’ mode, is particularly useful when observing faint objects.

2.9 Exposure meter

The spectrograph possesses an exposure meter which serves to measure the stellar flux and to accurately measure the mid-time of the exposure (flux weighted mean of the time). The mean time of the exposure delivered by the exposure meter is not used (yet) to correct the RV value.

This exposure meter consists of two photomultiplier tubes (one for each of the two fibres entering the spectrograph from the HCFA) which use the light picked up at the gap between the two sub-gratings of the echelle mosaic; no light is lost due to this design. The flux in both photomultipliers can be read at the instrument console. It is also recorded in the FITS header (cumulative, average and center of gravity). The expected count rates as a function of stellar magnitude and the estimated errors in RV are given in table 2.3. The number of dark counts per second fluctuates between 10 and 15.

Stellar magnitude	total count rate (cps)	error on mean time of exposure ϵ_{MTE} (sec)	worst case RV error (m/sec)
$m_v=0$	saturated	<1	0
$m_v=3$	2 850 000	<1	0
$m_v=5$	456 000	<1	0
$m_v=9$	12 000	<4.8	0.1
$m_v=14$	120	<51	1
$m_v=16$	19	<165	2.5
$m_v=17$	8 *	<312	5

Table 2.3: Expected count rate of the exposure meter as a function of stellar magnitude and estimated errors associated with the error on the photometric mean time of the exposure. Count rates are indicative, depend heavily on atmospheric conditions and slightly on stellar spectral type. Calculated.

2.10 System efficiency

The overall efficiency of the HARPS system over the complete wavelength range is given in Table 2.4. In this table the atmosphere+telescope transmission is standard atmospheric transmission plus aluminum reflectivity. The “slit efficiency” indicates an average value corresponding to $z=1$ and is calculated from the HARPS 1'' fibre together with the average La Silla seeing of 0.9''. The instrument efficiency includes the fibre link, scrambler and spectrograph (collimator in triple pass, echelle, cross disperser grism and camera). Instrument and CCD efficiencies are measured in the laboratory.

Wavelength	380	400	450	500	550	600	650	690	nm
Tel+atm	44	47	54	57	59	59	61	63	%
“slit”	46	47	48	49	50	50	51	52	%
instrument	10.2	15.7	20.7	22.2	24.2	21.8	19.3	16.4	%
CCD	65	78	85	85	81	79	76	72	%
total	1.35	2.67	4.44	5.18	5.70	5.07	4.58	3.81	%

Table 2.4: Overall efficiency of the HARPS system. See text.

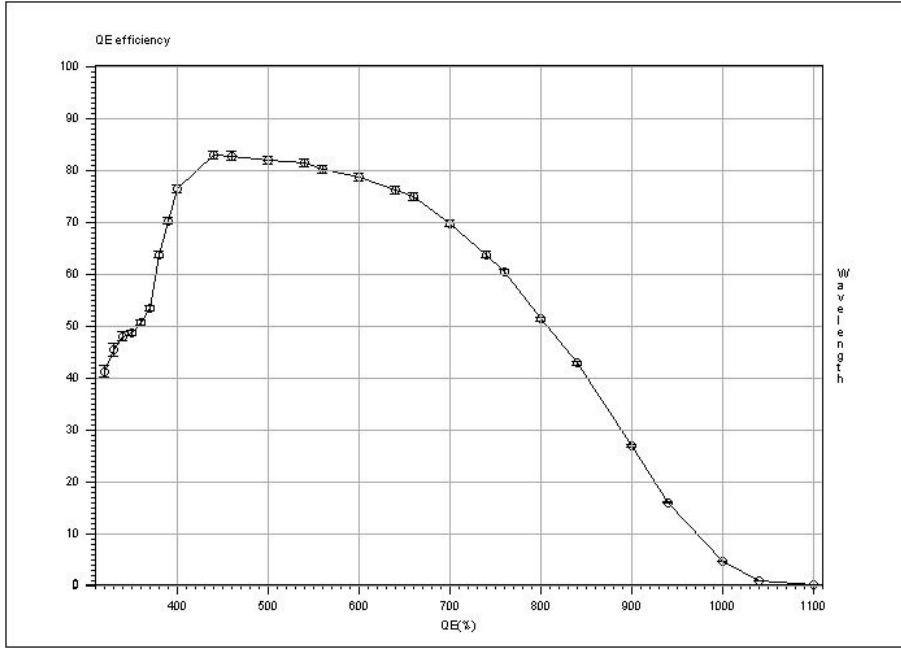

Figure 2.5: Quantum efficiency of Jasmin, the “red” CCD

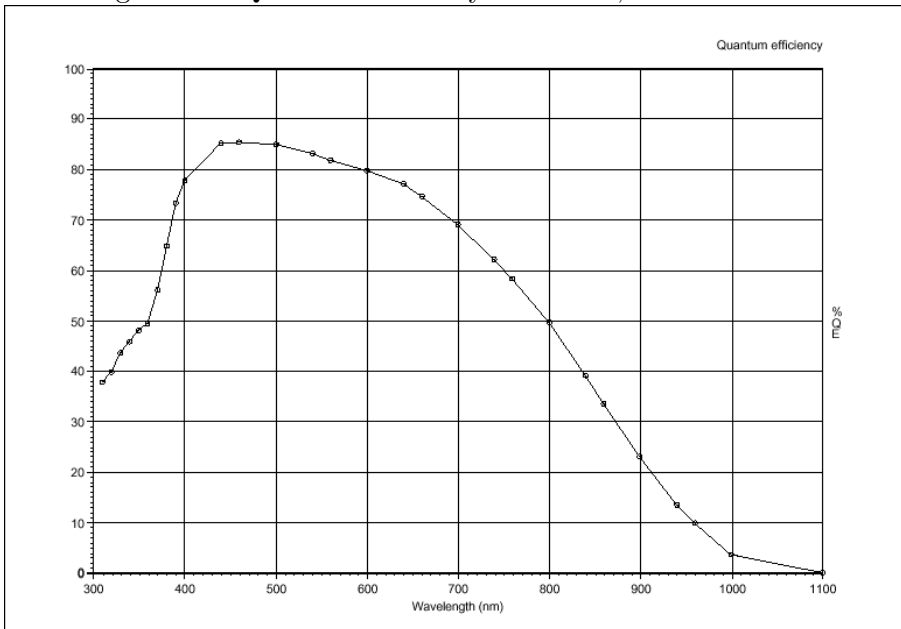

Figure 2.6: Quantum efficiency of Linda, the “blue” CCD

Chapter 3

HARPS Observing Modes

This chapter reviews the observing modes offered for HARPS. Information on Visitor Mode and Service Mode is provided in Chapter 5.

HARPS offers three observing modes:

1. Simultaneous Reference observations (with Fabry-Perot or Thorium)
2. Classical Fibre Spectroscopy (with or without sky)
3. Polarimetry

All these modes are used with the standard fibres A and B having a diameter of 1 arcsec on the sky and a diameter of $70\mu m$. These fibres comprise the standard HARPS high RV accuracy mode (dubbed ‘HAM’)

For Simultaneous Reference observations and Classical Fibre Spectroscopy, wider fibres can also be used (diameter of $100\mu m$, resulting in an projected aperture of 1.4 arcsec on the sky), offering more light at the expense of the RV precision. This high efficiency mode is dubbed ‘EGGS’ and is described in Section 3.4. This mode is useful for faint objects for which a radial velocity precision of ≥ 3 m/s is required.

3.1 Simultaneous reference method

The Simultaneous Reference mode is the base-line observation mode to get the best short term accuracy in radial velocity determination from the instrument. In this mode fibre B is fed by the Fabry-Perot etalon or the Thorium-Argon lamp while fibre A is on the science target.

A variable neutral density (ND) filter is used to keep the reference spectrum at a flux level equivalent to a 40 s exposure with zero density. Since the density to which the ND filter is set is computed by the instrument software from the exposure time as defined in the template, *the exposure time should not be modified after the execution of the OB has started. Otherwise the flux levels of both fibres will not be balanced and the simultaneous reference spectrum might be either saturated or weak.*

The Fabry-Perot lines or the Thorium lines which are recorded simultaneously with the stellar spectrum are used to allow to determine the instrument drift from the last wavelength calibration, which is usually taken in the afternoon before the observations. . If Thorium is used as simultaneous reference, then only the lamp ‘ThAr2’ can be used. However, due to its uniform lines distribution the use of Fabry-Perot is strongly recommended.

3.1.1 Calibrations

The Simultaneous Reference Method needs a sequence of calibration exposures to be taken before the beginning of the night. No further calibration exposures are required during the night.

In order to produce the correct calibration sequence the available observing block “RV Standard Calibration” should be executed *without changes* before the beginning of the night. It includes:

- **1 bias exposure.** The CCD bias is very stable, only one bias is therefore needed by the pipeline.
Template: HARPS_ech_cal_bias
- **2 Tungsten lamp exposures** where respectively fibre A and fibre B are successively fed by the Tungsten lamp.
These exposures are used for order location which is done automatically by the pipeline. The processed products are stored in the calibration database if they pass the quality control of the pipeline, and used for the subsequent reduction of the scientific exposures of the following night.
Template: HARPS_ech_cal_tun
- **Flat field: A sequence of 5 Tungsten lamp exposures** (defined by NREP=5) where both fibres are simultaneously illuminated.
This sequence is used by the data reduction pipeline for producing a spectral “master flat-field” which will be stored in the local calibration data base if it passes the quality control by the pipeline, and used for the subsequent reduction of the scientific exposures of the following night.
Template: HARPS_ech_cal_tunAB
- **Cross-fibre contamination measurements:** A sequence of 2 exposures is taken to measure cross-fibre contamination. In the first exposure in fibre A there is ThAr1 lamp and fibre B is empty. In the second exposure fibre A is empty and fibre B is illuminated by ThAr2 lamp.
- **2 COMB-COMB exposures (for reasons of redundancy)** in which both fibres are simultaneously illuminated by the Laser Frequency Comb. Template: HARPS_ech_cal_waveAB
- **2 FP-FP exposures** in which both fibres are simultaneously fed by light from the Fabry-Perot.
Template: HARPS_ech_cal_waveAB
- **2 ThAr-ThAr exposures** in which fibre A is illuminated by the ThAr1 lamp and fibre B by the ThAr2 lamp . Template: HARPS_ech_cal_thoAB
- **2 ThAr-FP exposures** in which fibre A is illuminated by the ThAr1 lamp and fibre B is fed by the light of the Fabry-Perot. Template: HARPS_ech_cal_waveAB

The ‘ThAr1’ -long term reference lamp- always illuminates fibre A, while the ‘ThAr2 lamp’ or the ‘Fabry-Perot’ -simultaneous references- illuminate fibre B. During the night only the Fabry-Perot or the ThAr2 lamp can be used as the reference. The use of the Fabry-Perot is strongly recommended.

Each exposure is used to build a wavelength solution. The instrumental drift with respect to the previous calibration frames is measured (expressed in m/s). If accepted by the built-in quality control, the wavelength solution is stored in the local calibration data base and used for the subsequent reduction of the scientific exposures of the following night.

The Laser Frequency Comb is used for wavelength calibration.

The user may then repeat a sequence of flat-fields with more than 5 exposures if a S/N higher than 300 is aimed at in later science exposures. As reference, 30 flat field exposures of 2.8 s each suffice to

reach a $S/N > 1000$ in the science frames taken in the HARPS instrument mode. The “RV Standard Calibration” acquires 5 flat exposures and reaches a Signal to Noise Ratio (S/N) of about $S/N=400$ at 450 nm, 500 at 550 nm and $S/N=900$ at 650 nm.

In case the “RV Standard Calibration” is not taken, the DRS will use the youngest available calibration data. This might introduce offsets, and possibly have a negative effect on the achievable precision.

The pipeline performs quality checks on each frame. In case one of the frames does not pass the quality check, the youngest available calibration data will be used. In this case it is however advisable to contact the support astronomer on site, in order to make sure the general health of the instrument is not compromised.

3.1.2 Observations

The necessary acquisition and observing templates are available:

- `HARPS_ech_acq_wavesimult` for star acquisition and setup of simultaneous reference (Fabry-Perot or ThAr lamp) exposures
- `HARPS_ech_obs_all` for taking simultaneous Fabry-Perot or ThAr lamp exposures

When using the EGGs instrument mode the templates with the “eggs” prefix should be used instead of the ones with the “ech” prefix which are dedicated to the HARPS mode.

For a detailed description of the templates see Section 5.4 and the HARPS Template Guide.

3.1.3 Pipeline, data reduction

The online pipeline does spectrum extraction, wavelength calibration in air wavelengths, RV calculation using a template spectrum of (ideally) the same spectral type as the target star. Stellar template spectra (binary masks) in air wavelengths for the following spectral types are employed in the cross-correlation:

- G2V
- K5V
- M2V

The pipeline applies the following corrections: detector bias, dark, flatfield, cosmic ray removal, and rebins the spectrum according to the wavelength calibration obtained in the afternoon or in the closest successful `HARPS_ech_cal_thoAB` exposures. The drift correction is not done. At present the drift is measured and inserted in the fits header, but is not applied to the RV value. The user can do this if he/she wishes, by simple subtraction.

Radial velocity and Julian date correction are calculated in the solar system barycenter reference (based on the Bretagnon & Francou 1988 VSOP87E planetary theory). Radial velocity computation is automatically done *for all exposure types* when a radial velocity value different from -99999 is provided by the `TARG_RV` parameter. Conversely, RV calculation can be turned off by entering “-99999”. The RV must be provided with an accuracy better than 1-2 km/s in order to reach the expected performance. For more details about the pipeline (Data Reduction Software, DRS) please, refer to the DRS user manual. For pipeline execution times see Section 5.5.1.

3.2 Classical fibre spectroscopy

Classical fibre spectroscopy can be done in two different ways, depending on the target and the goal of the program:

1. fibre A on target and DARK on fibre B (`objA` observation)
2. fibre A on target and fibre B on the sky (`objAB` observation)

`objA` observation should be preferred for objects much brighter than the sky/moon background where a careful CCD background correction may be needed. For this type of observation, the pipeline provides only the spectrum of the fibre A and uses fibre B order location to compute the CCD background.

`objAB` observation should be preferred when a sky-background correction may be needed. The data reduction pipeline provides an extracted spectrum for each fibre. The sky correction/subtraction is left to the user.

The high stability of the instrument makes wavelength drifts very small. If the same calibration sequence than for the simultaneous reference method is run before the beginning of the night, an RV accuracy generally better than 3 m/s along the whole night can be expected.

3.2.1 Calibrations

A calibration sequence similar to the Simultaneous Reference method is recommended before the beginning of the night.

3.2.2 Observations

The necessary acquisition and observing templates are available:

- `HARPS_ech_acq_objA` acquisition and setup for fibre spectroscopy with the object in fibre A
- `HARPS_ech_acq_objAB` acquisition and setup for fibre spectroscopy with the object in fibre A and sky in fibre B
- `HARPS_ech_obs_all` for fibre spectroscopy exposures

When using the EGGs instrument mode the templates with the “eggs” prefix must be used instead the ones with the “ech” prefix which are dedicated to the HARPS mode.

For a detailed description of the templates see Section 5.4 and the HARPS Template Guide (Section 1.1).

3.2.3 Pipeline, data reduction

The pipeline performs the same reduction as for the simultaneous reference method (Section 3.1.3) but obviously cannot correct for the instrumental drift. It does *not* perform sky subtraction ; this step is left to the user. For more details about the pipeline (Data Reduction Software, DRS) please, refer to the DRS user manual.

For pipeline execution times see Section 5.5.1.

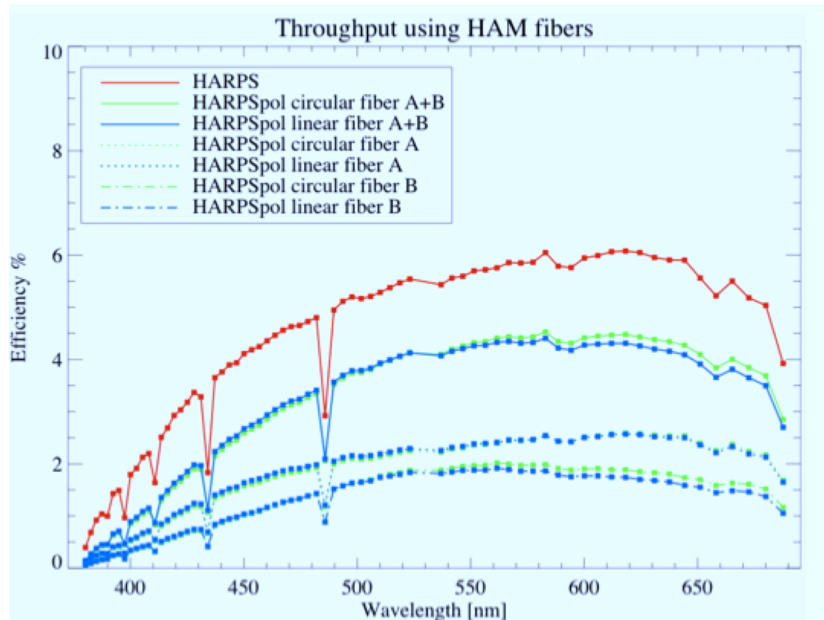

Figure 3.1: Throughput of HARPS with and without the polarimeter, for both the linear and the circular polarimeter.

3.3 Polarimetry

The HARPS polarimeter allows to perform both linear and circular polarization. The retarder wave plate is located in the HCFA, above the fiber head. Only the high accuracy mode (HAM) fibers can be used in conjunction with the polarimeter.

3.3.1 The HARPS polarimeter

The polarimetric system of HARPS consists of two super-acromatic rotating wave plates, one for linear and one for circular polarimetry. The light is separated in two separate beams by a polarizing beam splitter (Foster prism) and imaged on the object and the sky/reference fibers of HARPS. After splitting by the Foster prism, a second prism channels the second beam into the sky/reference fiber. The instrument polarization has been measured to be less than 10^{-4} (upper limit) for zenith angles smaller than 60 degrees, while the cross-talk of the polarization signal, is lower than 10^{-3} (upper limit). An appropriate sequence for circular polarimetry, via the quarter wave plate (QWP) is:

- QWP at 45° : $S^L = \frac{1}{2}(I + V)$, $S^R = \frac{1}{2}(I - V)$
- QWP at -45° : $S^L = \frac{1}{2}(I - V)$, $S^R = \frac{1}{2}(I + V)$

while for linear polarimetry the half wave plate (HWP) should be oriented:

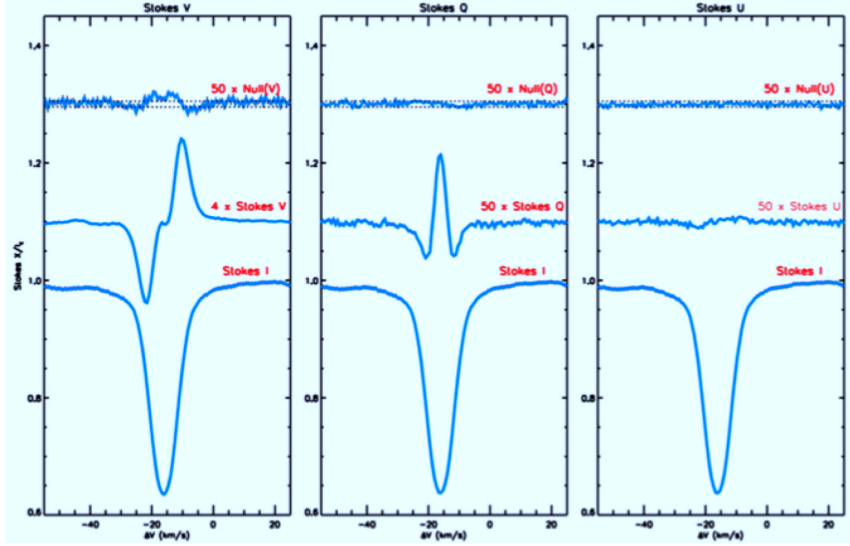

Figure 3.2: Polarized line profiles of the star γ Equus

- HWP at 0° : $S^L = \frac{1}{2}(I + Q)$, $S^R = \frac{1}{2}(I - Q)$
- HWP at 45° : $S^L = \frac{1}{2}(I - Q)$, $S^R = \frac{1}{2}(I + Q)$
- HWP at 22.5° : $S^L = \frac{1}{2}(I + U)$, $S^R = \frac{1}{2}(I - U)$
- HWP at -22.5° : $S^L = \frac{1}{2}(I - U)$, $S^R = \frac{1}{2}(I + U)$

The pipeline recipe reducing polarimetric data requires that the following pair angles are taken in sequence for the computation of the V , Q , and U stokes parameters:

- for V , angles 45° and 135° ; or 225° and 315°
- for Q , 0° and 45° ; 90° and 135° ; 180° and 225° ; 270° and 315°
- for U , 22.5° and 67.5° ; 112.5° and 157.5° ; 202.5° and 247.5° , 292° and 337.5°

However the user is free to select as many angles as wanted in the polarimetric sequence (template HARPS_pol_obs_all).

3.3.2 Performance

Preliminary measurements of the throughput indicate a light loss with respect to the base mode of HARPS in the range of 20% to 30%, increasing to $\approx 40\%$ in the bluest orders (see Figure 3.1).

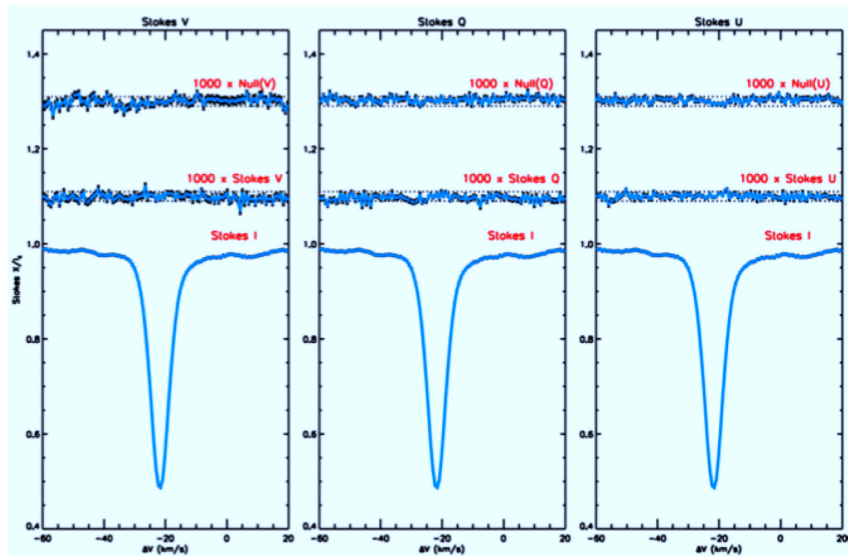

Figure 3.3: Line profiles of α Centauri in the three Stokes parameters.

3.3.3 Calibrations

There are two calibration templates, one for circular and one for linear polarization. They are used for flat fielding with the respective polarimeter:

```
HARPS_pol_cal_tun_cir
HARPS_pol_cal_tun_lin
```

3.3.4 Observations

Two dedicated acquisition templates and one observation template are used to observe with the polarimeter. The templates are:

```
HARPS_pol_acq_cir
HARPS_pol_acq_lin
HARPS_pol_obs_all
```

The acquisition templates have the usual entry fields, while the observation template contains the series of retarder wave plate angles over which to perform the polarimetric observations. In polarimetric mode, the field of view of the acquisition camera is reduced to 30 arcsecs.

3.3.5 Pipeline, data reduction

There are pipeline recipes to reduce both the calibrations and the spectro-polarimetric science observations. They are run online automatically from the HARPS pipeline application. Although users

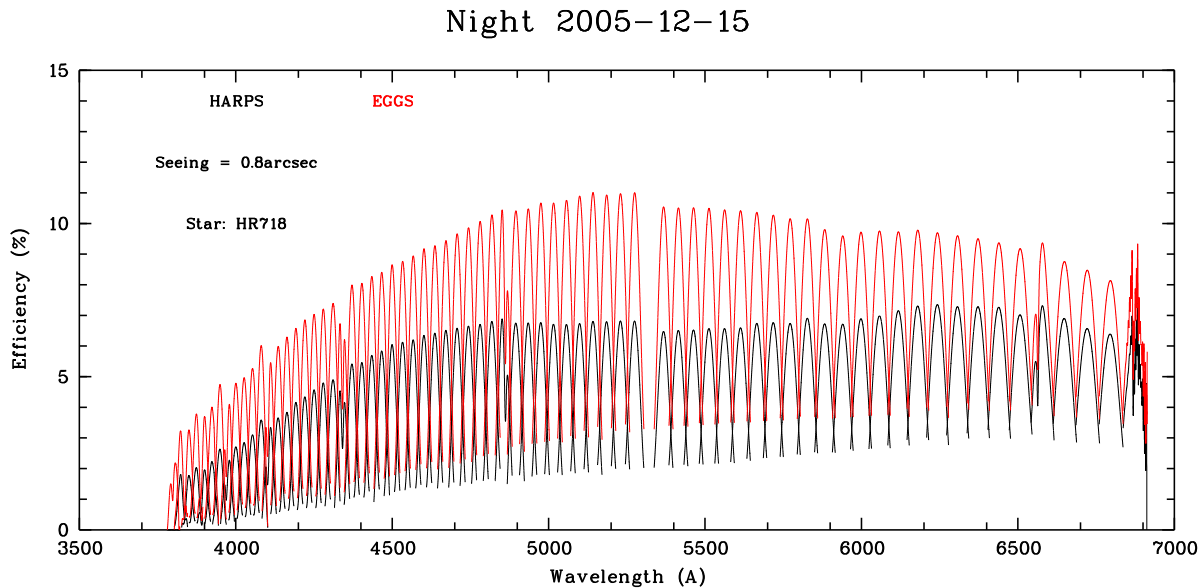

Figure 3.4: HAM - EGGs comparison

are free to choose any angle for the retarder plate, the DRS expects observations to be taken in certain pairs. Refer to Chapter 3.3.1 for this list of angles.

The data products are 5 fits files containing a one dimensional spectrum. They contain the Total flux (I), and the U/I, Q/I, V/I ratios. The "null" spectrum, containing the uncertainty on the Stokes parameters is also available.

3.4 HARPS high efficiency mode: EGGs

Since October 2006 the high efficiency mode of HARPS, dubbed 'EGGs' mode, is available to the users. This mode uses a set of wide fibres with a projected aperture on the sky of 1.4 arcsec and a diameter of $100\mu\text{m}$ (while the standard HARPS (HAM) fibres have an aperture of 1 arcsec and a diameter of $70\mu\text{m}$). The EGGs mode gains a factor of 1.75 in flux with respect to the standard HARPS (HAM) mode with a seeing of 0.8 arcsec (see fig. 3.4). The best RV accuracy reachable with the EGGs fibre mode is about 3 m/s.

From the point of operations, observing in the EGGs mode is identical to HAM. However, the templates with the "eggs" prefix must be used and not the ones with the "ech" prefix (which are dedicated to HAM).

The ghost contamination is higher in the EGGs mode than in the HAM one; in particular, the reflected order which crosses the detector perpendicularly to the main dispersion direction, has an

	HAM	EGGS
flux (seeing=0.8")	1	1.75
best RV accuracy	≤ 1 m/s	3 m/s
diffuse light at 590nm	1%	2.5%
strongest ghost intensity	$\leq 1\%$	1% – 10%

Table 3.1: Comparison of the HAM and EGGS performances.

intensity, in EGGS mode, ranging from 10% to 1% of the flux of the regular echelle orders, the higher value being in the blue side. The same reflected order in HAM mode has an intensity generally below 1% of the flux of the regular echelle orders.

The diffuse light at 590 nm is about 2.5% for the EGGS mode, to be compared to $\approx 1\%$ of the HAM mode.

In Table 3.1 the HAM and EGGS mode performances are compared.

The EGGS mode may prove particularly useful to RV programs studying faint objects where the RV accuracy is strongly limited by the photon noise.

Users planning to use this mode should declare this in the proposal, as this requires a change in the instrument configuration.

Chapter 4

RV Precision

The high RV precision obtainable with HARPS is a result of an extremely stable and strictly controlled instrument and a data reduction software designed and optimized for the purpose. The pipeline RV determination is optimized for data taken in the simultaneous Thorium reference method.

The short term RV precision of HARPS with the simultaneous Thorium reference method has been demonstrated, during the three commissioning phases, to be below 1 m/s.

The RV precision can be affected by several factors external to the instrument:

- photon noise
- telescope focus
- centering errors
- Thorium calibration errors

As an example during the second HARPS commissioning (June 2003), a 7 hours series of short exposures on α Cen B was recorded, yielding a RV rms of 0.52 m/s. Of these, 0.45 m/s are due to the stellar oscillation, 0.17 m/s to photon noise, 0.08 m/s to Thorium calibration errors (drift tracking) and the remaining 0.18 m/s to centering errors, telescope focus errors and any other error source not yet identified.

The following systematic study is from data obtained with the simultaneous reference method.

4.1 Photon noise

For estimates of the signal-to-noise ratio (S/N) in the HARPS mode under given observing conditions the Exposure Time Calculator (ETC) available via the HARPS webpage (<http://www.eso.org/observing/etc/>) can be used with an accuracy of about 10% (see Section 5.6).

As a rule of thumb, for a G2 star an RV precision of ≈ 1 m/s can be reached with a S/N ratio of about 100 per spectral pixel in the stellar continuum (at 550 nm); such a S/N ratio can be reached for a 6th-magnitude G2 star with 60 s in the HARPS mode under good seeing conditions.

The photon noise introduced in the RV measurement, consequently, scales approximately as:

$$\text{rms(m/s)}_{\text{photon}} \approx \frac{100}{S/N_{550 \text{ nm}}}. \quad (4.1)$$

In the EGGs mode the efficiency increases by up to a factor of 2 with respect to what indicated by the exposure meter with a seeing of $1.4''$, but the RV precision of this mode is limited due to systematics to ≈ 3 m/s.

4.2 Telescope focus

A defocus of the telescope of 30 encoder units introduces a RV offset of 1 m/s. In a typical focus sequence, which can take from 5 to 10 minutes, is reached a precision in the determination of the optimum focus of 5-10 encoder units.

4.3 Centering/defocusing errors

The new, octagonal fibres installed on June 1st, 2015, perform good light scrambling, and no RV variation is measured when de-centering or de-focusing of the science target occurs. This is a huge improvement compared to the old circular fibres, where de-centering by 0.5 arcsec introduced an RV offset up to 3 m/s.

The current tip-tilt guiding systems (since 2010) is calculated to contribute with 10 cm/s to the radial velocity error budget. This is an improvement to the old guiding / dynamic centering system (2003–2010) which introduced an RV error up to 20 cm/s (rms),

4.4 Thorium calibration errors

An error of about 50 cm/s is given to the Thorium calibration (drift tracking and zero point). Thanks to recent the improvement in wavelength calibration recipe, the errors are lower than ~ 30 cm/s.

4.5 Laser Frequency Comb calibration errors

The wavelength calibration error of the Laser Frequency Comb is 4 cm/s (photon noise limited).

4.6 EGGs RV precision

The highest radial velocity precision that can be attained in the EGGs mode is about 3 m/s.

4.7 2015 fibre exchange and its impact on RVs

On June 1st, 2015, a new set of non-circular, octagonal optical fibres, with improved mode-scrambling capabilities, was installed. This drastically improved the throughput of HARPS (e.g., by 40% at 550 nm), its illumination uniformity and stability, and thus the overall radial velocity (RV) stability.

Due to the exchange of the fibres and the re-adjustment of the spectrograph focus, the instrumental profile (IP) of the spectrograph significantly changed. IP changes, especially if the IP is not perfectly symmetric, affect absorption and emission lines differently. An asymmetric IP may introduce an apparent shift of the spectral line that depends on the line width. For this reasons, all data taken after the fibre exchange exhibit an RV offset in comparison to those data taken prior to the upgrade.

Thus, when comparing RV data taken before the fibre exchange in June 2015 with RV data taken after it, the correct RV offset must be known and considered.

However, there is no general RV offset value for all stars, as this effect mainly depends on the individual spectral type, line width, stellar jitter and the calibration mask used. As a rule of thumb, we observe a trend that the RV offset is smaller for narrower stellar lines; we observe RV offsets on the order of 17-20 m/s for late F-type stars with the G2 mask, 10-18 m/s for G-type stars with the G2 mask, 10-15 m/s for K-type stars with the K5 mask, and -2 to 0 m/s for early M-dwarfs with the M2 mask. More information is provided in the ESO Messenger article “HARPS Gets New Fibres After 12 Years of Operations” by Lo Curto et al., Messenger 162, 9 (2015).

Chapter 5

Preparing the Observations

5.1 Visitor Mode and Delegated Visitor Mode

HARPS is offered in Visitor Mode (VM) and Delegated Visitor Mode (dVM) only. Service Mode is not offered. More information on VM and dVM is provided in the latest Call for Proposals.

5.2 Requirements

HARPS uses the standard ESO way of observing, i.e. pre-prepared Observing Blocks (OBs). The following sections in this chapter describe the philosophy behind this concept, the available tools and the HARPS specific input.

In order to reach the full performance of HARPS with respect to the determination of accurate radial velocities, the following items should be noted:

1. to achieve an accurate solar system barycentric Radial velocity, correction of 1 m/s, the target coordinates must be known to within $6''$ including proper motion
2. the RV of a star needs to be known to within 1-2 km/s to give the pipeline a reasonable starting point for the RV computation.

From the point of view preparation of the observations the EGGS mode is identical to the HARPS one. Only the templates with the “eggs” prefix should be used instead than the templates with the “ech” prefix which are dedicated to the HARPS mode.

5.3 Introducing Observing Blocks

An **Observing Block (OB)** is a logical unit specifying the telescope, instrument and detector parameters and the actions needed to obtain a “single” observation. It is the smallest “schedulable” entity, which means that the execution of an OB is normally not interrupted as soon as the target has been acquired and centered on the fibre. An OB is executed only once; when identical observation sequences are required (e.g. repeated observations using the same instrument setting, but different targets), a series of OBs must be built.

Usually, one OB consists of two separate entities: the acquisition template and the observation template(s). For normal science observations HARPS uses four different acquisition templates (dif-

Template	Fiber A	Fiber B
HARPS_ech/eggs_acq_wavesimult	Star	FP or ThAr2 lamp
HARPS_ech/eggs_acq_objA	Star	Dark
HARPS_ech/eggs_acq_objAB	Star	Sky
HARPS_ech/eggs_cal_thoAB	ThAr1 lamp	ThAr2 lamp
HARPS_ech/eggs_cal_waveAB	ThAr/Comb/FP	ThAr/Comb/FP
HARPS_ech/eggs_cal_tun exposure 1	Tungsten	Dark
HARPS_ech/eggs_cal_tun exposure 2	Dark	Tungsten
HARPS_ech/eggs_cal_tunAB	Tungsten	Tungsten
HARPS_pol_acq_cir	Circular pol.	Circular pol.
HARPS_pol_acq_lin	Linear pol.	Linear pol.
HARPS_pol_obs_all	Polarimeter	Polarimeter

Table 5.1: Fiber illumination scheme for each template.

ferent for the various observing modes) and one common observing template . They are described in Section 5.4 and the HARPS Template Guide.

5.4 P2PP

P2PP is the standard tool for the building of observing blocks from the instrument specific templates. A comprehensive description including the user manual is available from the ESO web pages at <http://www.eso.org/sci/observing/phase2.html>.

Observers using HARPS in Visitor Mode should prepare their OBs in advance using the HARPS Instrument Package, which is automatically downloaded once P2PP is started and the HARPS program is selected from the list of the user’s approved programs. OBs prepared at the observer’s home institution can be quickly imported (after having ftp’ed them in the proper machine in La Silla) in the P2PP running at the telescope console and be ready for execution.

For a concise description of all HARPS templates and the parameters selectable with P2PP consult the “HARPS Template Guide” (see section 1.1).

In table 5.1 is shown the fibers illumination scheme as a function of the template used.

5.4.1 Acquisition templates

HARPS uses the acquisition template to preset the telescope and to set up the instrument configuration for the selected observing mode. The following acquisition templates are available:

- HARPS_ech_acq_wavesimult for simultaneous FP or ThAr2 exposures
- HARPS_eggs_acq_thosimult for simultaneous ThAr2 exposures with EGGS
- HARPS_ech/eggs_acq_objA for fibre spectroscopy (no sky)
- HARPS_ech/eggs_acq_objAB for fibre spectroscopy (with sky)
- HARPS_pol_acq_cir for circular spectro-polarimetry
- HARPS_pol_acq_lin for linear spectro-polarimetry

We note that the HARPS_ech_acq_thosimult will be decommissioned and replaced by the HARPS_ech_acq_waves template.

All the acquisition templates require an initial guess of the RV of the star. For optimum RV determination the expected radial velocity of the source should be entered within 2 km/s. In case the RV value is not known the value “S/N” will start an iterative process which will stop once the input and the output RVs differ by less than 1 km/s. If RV computation is not desired the RV initial guess should be set to ‘-99999’.

A concise description of the acquisition templates is given in the HARPS Template Guide (see Section 1.1).

5.4.2 Observing templates

HARPS uses two observation templates, one for spectro-polarimetry and one for all the other observing modes. All instrument setup is done by the acquisition templates:

- HARPS_pol_obs_all for exposures in spectro-polarimetric mode
- HARPS_ech/eggs_obs_all for exposures in the HAM/EGGS observing modes.

A concise description of the observation template is given in the HARPS Template Guide.

5.4.3 Calibration templates

Several calibration templates are available. However, all calibrations necessary for a proper data reduction with the online pipeline are performed by the ready-to-run calibration OB (named “RV Standard Calibration”). The details of this OB are described in section 3.1.1.

Only if additional calibrations are deemed necessary one needs to use one (or more) of the following templates:

- ech_cal_bias for taking bias frames
- ech_cal_dark for taking dark frames
- ech_cal_thoAB for taking a wavelength calibration using the ThAr lamps through both fibres
- ech_cal_waveAB for taking a wavelength calibration with ThAr or COMB or FP reference frames for drift measurements.
- ech_cal_tun for taking order location frames through fibres A and B
- ech_cal_tunAB for taking spectral flat field exposures simultaneously through fibres A and B
- ech_cal_tunUSER for taking user defined tungsten exposures
- HARPS_pol_cal_tun_cir flat field with the circular polarimeter
- HARPS_pol_cal_tun_lin flat field with the linear polarimeter

If the number of exposures is set different from one in the ech_cal_tunAB or ech_cal_thoAB templates, the pipeline will wait for the last exposure, sum all the exposures and then process the resulting frame. A concise description of the observation template is given in the HARPS Template Guide.

5.5 Overheads

5.5.1 Execution time overheads

Item	time
telescope preset incl dome rotation	5 min (upper limit for large, more than 180 deg, dome rotation) 2 min (typical for new pointing within a few degrees from the previous position)
Fibre automatic redefinition and centering of object on the fibre, start of guiding	1 min
instrument configuration	<30 s
readout time (incl writing of FITS headers and transfer to IWS)	23 s with 416 kpx/s readout speed, 87 s with 104 kpx/s readout speed
minimum time between successive exposures	32 s (416 kpx/s)
telescope focusing (at the beginning of the night, to be repeated 4-5 times during the night)	10 min
HARPS/EGGS or HARPS/CES instrument change	≈ 1 min
Polarimeter insertion	15 s (circ.), 30 s (lin.), 15 s (switch lin. - circ.)
Polarimeter full rotation	12 s

Table 5.2: Execution times overheads

5.5.2 “Off-line” overheads

Item	time
DRS pipeline for <code>thosimul</code> without RV computation	110 sec
DRS pipeline for <code>objA</code> without RV computation	50 sec
DRS pipeline for <code>objAB</code> without RV computation	70 sec
DRS pipeline extra time for each RV calculation	30 sec/spectrum
ThAr lamp pre-heating (once at the beginning of the night)	2 min minimum, 10 min recommended, 15 min maximum

Table 5.3: “Off-line” overheads

The pipeline overheads are for reference only, observations can proceed without the need for waiting the pipeline results. ThAr lamp pre-heating overhead have to be considered before the start of the afternoon calibrations.

5.5.3 Fast time series observations (asteroseismology)

The shortest exposure time possible with the HARPS shutter is 0.2 seconds, while the shortest exposure in simultaneous thorium exposure mode is 15 seconds (minimum exposure time to achieve a

15 cm/sec instrument drift tracking). For each CCD frame there is an overhead (readout, attachment of fits header etc.) of ~ 32 seconds in the fast readout mode (416 kpx/sec). With 15 sec exposure time on sky, 50 seconds cycles have been achieved. The pipeline presently implemented is able to reduce this flood of data in nearly real-time. Reduction of one frame lasts about 24 seconds, the pipeline: no frames will be left behind.

5.6 The HARPS Exposure Time and Spectral Format Calculator

The HARPS Exposure Time Calculator (ETC) models the instrument and detector in their different configurations (the EGS mode is not included yet, but take as a reference a gain of 2 in flux with a seeing of $1.4''$). It can be used to compute the detailed spectral format (wavelength and order number as function of position on the detector) and the expected S/N for the specified target under given atmospheric conditions as a function of exposure time. It is available via the HARPS web pages <http://www.eso.org/observing/etc/bin/gen/form?INS.NAME=HARPS+INS.MODE=spectro>.

Chapter 6

Observing with HARPS

6.1 Before the night

Depending on the observing method applied (simultaneous reference, classical fibre spectroscopy) different sets of calibration exposures need to be taken before the start of the science observations.

For both methods, it is necessary to take a series of calibration exposures (Bias, Tungsten, Thorium) because they are needed for the pipeline to produce optimum results. A calibration OB (“RV Standard Calibration”) is available at La Silla and ready for execution to take these exposures. Details are described in Section 3.1.1.

6.2 During the night

Observations are performed in the standard VLT way, i.e. OBs are selected by the Visiting Astronomer (VA) with P2 and fetched by the Telescope/Instrument Operator (TIO) into BOB.

6.2.1 Target acquisition, guiding, focusing

Target acquisition is done by the TIO.

The object is centered on the entrance of the science fibre and kept there thanks to the telescope guiding system. The original guiding system of the 3.6m telescope was based on sending the guiding corrections directly to the 200 tons telescope, which would move with a mechanical relaxation time of the order of 2-3s. Therefore corrections were applicable with a maximum frequency of 0.3Hz. This was not very efficient, especially in the case of “fast” perturbations, such as wind shaking or mechanical “jumps”, e.g. of the tracking gears. The shortcoming of this system was that it had to move a very large mass, with a large inertia and a consequently large time constant. A new system was designed with the goal to be able to send corrections with a frequency of up to 10Hz. Rather than moving the whole telescope, a small refraction glass, 32mm thick, is put in the optical axis, close to the focal plane of the telescope. Tip and tilt movements of this glass displace the image of the star on the focal plane and permit an accurate centering of the star on the fiber. As the mass to move decreased from about 200 tons to about 2 kg, the time constant decreased as well, and this system is able to apply guiding corrections with a frequency of up to 10Hz. It is named “Tip-tilt guiding system”, and it is the default guiding strategy applied since October 2011. The expected contribution to the RV error budget of this system is of ~ 10 cm/s, to be compared with the former system where the contribution was of about $\sim 20-40$ cm/s. The “old” telescope guiding strategy can still be used instead of tip-tilt guiding if necessary. This decision will be taken by the telescope

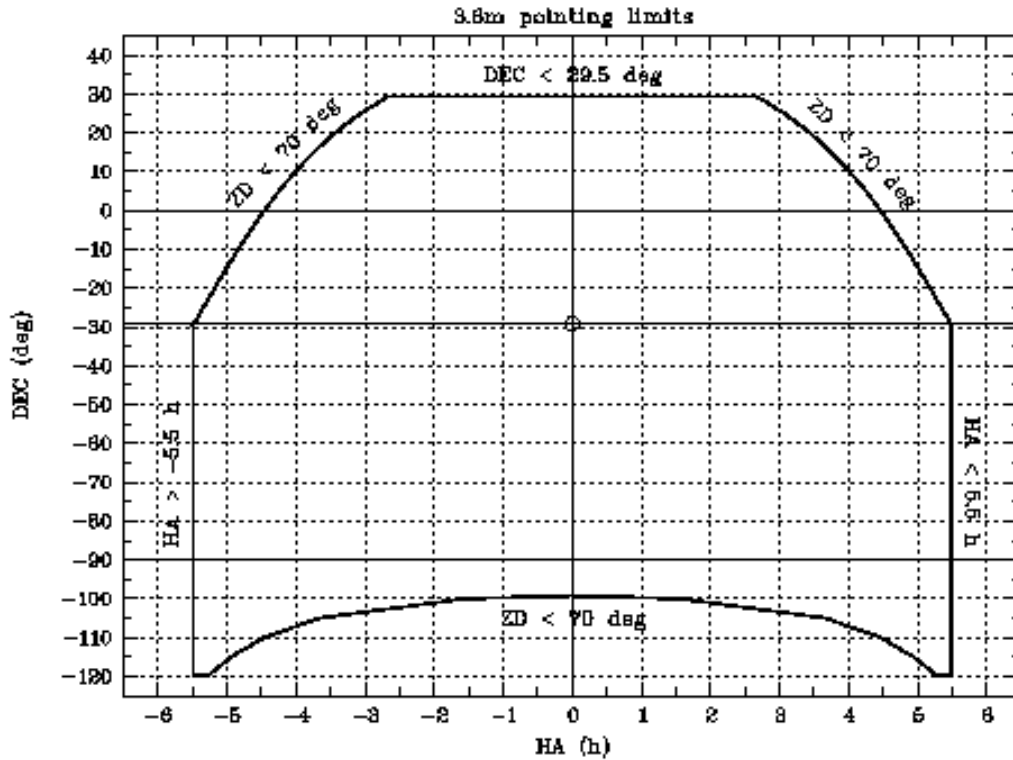

Figure 6.1: The sky area accessible for HARPS

operator, and the user does not have to worry at all about the guiding. We are only adding this information for completeness.

In the fibre AB spectroscopy mode (object + sky) the observer should verify that the sky fibre is not contaminated by light from other sky objects. This should in the first place be done by checking on the Digital Sky Survey. At the telescope it can be verified by

- offsetting the telescope: the sky fibre entrance is exactly $114''$ west of the target fibre;
- watching the count rate of the exposure meter (photometer B).

It is important that the telescope is well focused at all times. It is recommended to have a through focus sequence performed using the guiding camera and the exposure meter two to three times per night or whenever the image quality observed on the guiding camera deteriorates significantly, or whenever there is a significant temperature change (few $^{\circ}\text{C}$). A defocusing of ± 30 encoder units introduces an RV error of $\pm 1\text{m/s}$. The accuracy of the telescope focus determination is within 10 encoder units.

6.2.2 Pointing restrictions and weather limits

The usual pointing limit restrictions of the 3.6m telescope apply, see Fig. 6.1.

The telescope shall not be pointed into the wind when the wind speed is higher than 14 m/sec (3.6m monitor).

The telescope dome will be closed when any of the following weather conditions occur :

- Wind speed $> 18\text{ m/sec}$ (on the 3.6m monitor)

- Humidity $>80\%$ (on the 3.6m monitor)
- Temperature within 3° of dew point (on the MeteoMonitor)
- Dew on the dome (the TIO will check the dome in person when there is reason to believe that condensation may occur)
- Sky overcast with dark clouds threatening rain

The TIO will take the decision to close the dome as necessary, and the VAs have to accept the decision since the reason is exclusively the protection of the telescope from damage.

The dome may be re-opened if weather conditions improve and stay below the operating limits for at least 30 minutes. This waiting period is particularly important in case of humidity. The TIO will further confirm that the condensation on the dome has completely evaporated.

6.3 Night calibrations

Night time calibrations are only taken upon request.

6.4 Real-time display

Raw data coming from the instrument are displayed on a FIERA Real-Time Display (RTD). Both CCDs are displayed in the same RTD (fig. 6.2).

6.5 Observing very faint stars

As explained in Section 3.1 a variable neutral density filter is used to balance the intensity of the Thorium-Argon calibration spectrum depending on the exposure time. This works correctly for exposure times up to 2700 s.

For very faint stars which require even longer exposures this may lead to an overexposure of the calibration spectrum with contamination of the stellar spectrum. As the ultimate accuracy of HARPS (1 m/s) will usually not be reached on such faint stars, it is recommended not to use the simultaneous reference method but to rely on the excellent short-term stability of HARPS and take separate wavelength calibration exposures immediately before and after the science exposure to interpolate and remove possible instrumental drift errors. The additional time spent on this is negligible given the long science integration.

6.6 Asteroseismology

Asteroseismology observers need to pay special attention to the guiding parameters. Guiding corrections should be faster if the exposure time is short. For example, if the exposure time is less than 5 seconds, guiding correction time should be no more than 2 seconds; this is also the maximum correction frequency we can use for guiding, due to the telescope reaction time.

The dynamic fibre centering correction time should be set to 10 - 15 minutes (maximum 30 minutes), however a quite long time interval which shall not be the same, nor a fraction of the period of the star's oscillations which are being measured. The rationale behind this choice is to diminish the low

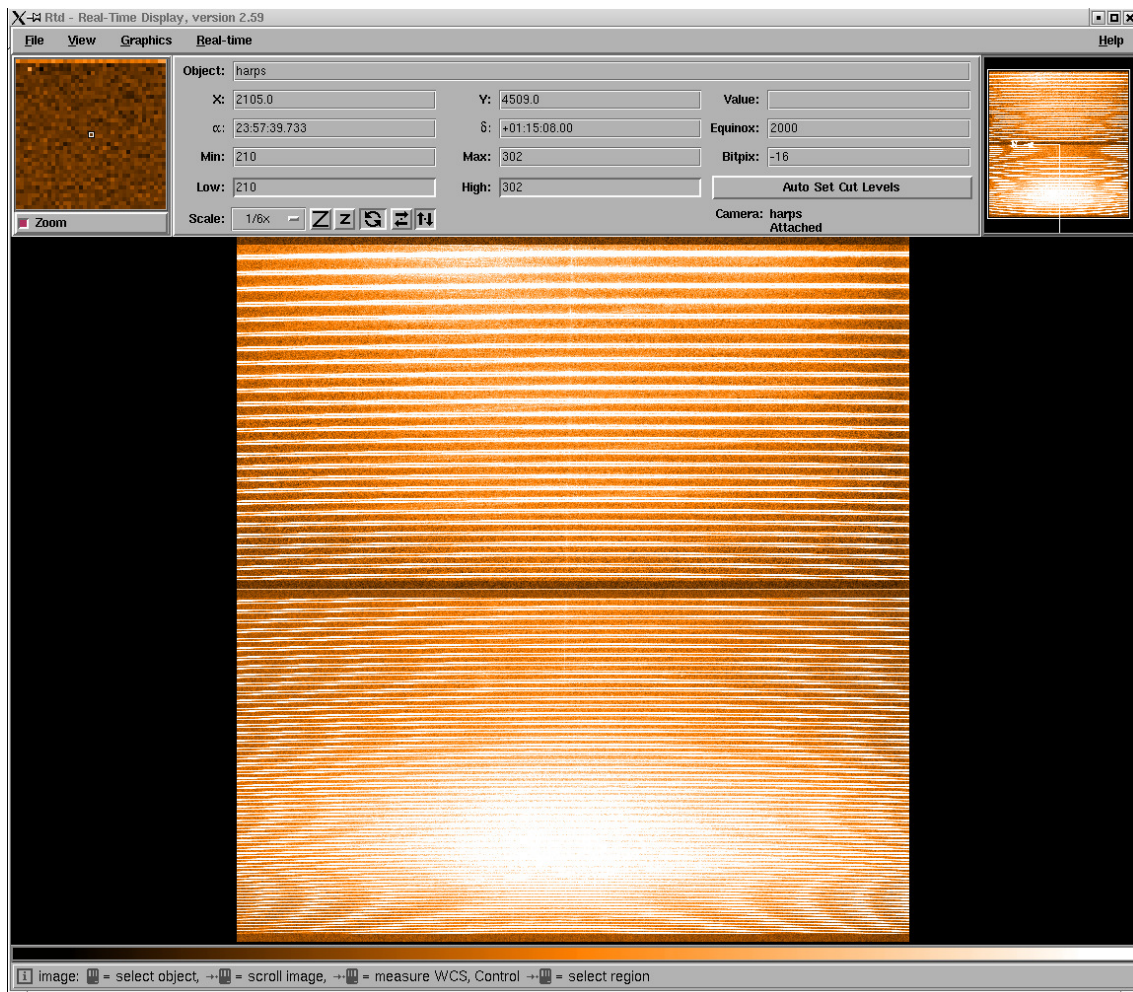

Figure 6.2: The Real Time Display of a HARPS spectrum taken with the tungsten lamp illuminating both fibers. The lower part is the blue chip (“Linda”), the upper one is the red chip (“Jasmin”). Wavelength increases from lower left to upper right.

frequency noise in the RV power spectrum. The minimum correction time for the dynamic fibre centering algorithm is 30 s.

As from June 2004, a periodic signal is detected in the RV power spectrum at 2.8 mHz and aliased at about 6 and 9 mHz. This is possibly due to a hard point in the right ascensions main gear or motor and we are trying to fix it. The users however should be aware of it. The amplitude of this signal can reach 30 cm/s. This noise is only noticed in short (< 20 seconds) exposures. When using exposure times larger than ≈ 20 seconds the guiding is able to compensate the glitch introduced by the gear/motor.

Observers should ask the operators proper setting of the guiding and dynamic centering parameters.

6.7 End of the night

No further calibrations are necessary after the end of the science observations. To prolong the life of the calibration lamps HARPS is switched to the so-called “Dark” mode. All lamps still in use at the time are thereby switched off and the dust cover in the fibre adapter is put in place to protect the fibre entrance. All electronics are in stand-by, all internal house-keeping functions (temperature and pressure control, logging) continue to operate.

Chapter 7

The Reduction and Archiving of HARPS Data

7.1 The HARPS data reduction pipeline

The sophisticated Data Reduction Software (DRS) is an integral part of the HARPS system.

Once the “trigger” software is started, the pipeline reduction waits for new raw data files to appear on the data reduction workstation (`whaldrs`) in the `/data/raw/night` directory (where *night* is the name of the subdirectory named after the day on which the observing night started, e.g. *2019-02-01*).

Every HARPS frame is processed by the online pipeline. Depending on the observation, the pipeline uses different reduction recipes (see Sections 3.1.3 and 3.2.3). For each frame being processed, the pipeline performs basic quality checks. When a problem is encountered an error message is displayed to warn the user.

Results of the reduction of science data are:

- extracted spectrum (all modes) in air wavelengths.
- precise radial velocity (only if parameter `TARG_RV` is defined and $\neq -99999^1$)
- cross-correlation function (CCF; only if parameter `TARG_RV` is defined and $\neq -99999$).

Data reduction takes around 30 s per frame (see Section 5.5.1). Once finished, the pipeline output is immediately available. The output of the pipeline is archived together with the raw data in `/data/reduced/night` and is then automatically transferred to the ESO Science Archive Facility (<http://archive.eso.org/>).

Calibration frames are also processed by the pipeline. If they pass the quality check then the calibration database is updated. Otherwise an error message will be displayed and the latest entry in the calibration database will be used.

The manual of the DRS can be found online:

<http://www.eso.org/sci/facilities/lasilla/instruments/harps/doc/DRS.pdf>

¹If the parameter `TARG_RV` is defined equal to `-99999` the software will compute the radial velocity in an iterative manner. This is useful when the RV of the object is not known a priori with an accuracy of ≈ 2 km/s.

7.1.1 High accuracy radial velocities

The reduction concept applied by the pipeline for the calculation of high accuracy radial velocities using the reference method is described in the paper “ELODIE: A spectrograph for accurate radial velocity measurements” by Baranne, Queloz, Mayor et al., A&AS **119**,373(1996).

To achieve the full performance of the pipeline with respect to the determination of accurate radial velocities, the following items should be noted:

1. to achieve an accurate solar system barycentric Radial velocity, correction of 1 m/s, the target coordinates must be known to within 6'' including proper motion
2. the RV of a star needs to be known to within 1-2 km/s to give the pipeline a reasonable starting point for the RV computation.

7.1.2 Iodine cell data (until 2004)

The iodine cell mode was decommissioned in 2004. For data taken in this mode, the DRS has only produced an air wavelength calibrated spectrum. For further analysis the observer should consider the following input data:

1. high S/N template spectrum of the science object (without I_2 cell)
2. high S/N spectrum of a B star taken through and without the I_2 cell during the same night as the template spectrum of the science object,
3. Fourier transform spectrum of the Iodine cell. For the decommissioned HARPS Iodine cell this FTS can be requested from the La Silla Science Operations team (email: ls-harps@eso.org).

The extraction of the I_2 information itself is left to the astronomer; no further support is provided from ESO.

The description of one method to model the I_2 data is given in the paper: “The planet search program at the ESO Coudé Echelle Spectrometer. I. Data modeling technique and radial velocity precision tests.” Endl M., Kürster M., Els S., 2000, A&A, 362, 585

also available from the web:

<http://aa.springer.de/bibs/0362002/2300585/small.htm>

7.2 Data products and archiving

7.2.1 Data products

HARPS writes FITS files with extensions containing the data of both CCDs. The size of one raw data file is approximately 32MB.

By default the data products of the online pipeline are archived. Following is an example of the files that are included in the archiving of one exposure:

- Raw data file:
HARPS.2003-11-01T02:40:09.824.fits

- Cross-correlation function summary table with extracted RV per each order:
HARPS.2003-11-01T02:40:09.824_ccf_G2_A.tbl
- Cross-correlation function matrix in fits format for mask G2:
HARPS.2003-11-01T02:40:09.824_ccf_G2_A.fits
- 2D extracted spectrum, one row per order:
HARPS.2003-11-01T02:40:09.824_e2ds_A.fits
- 1D extracted full spectrum, wavelength calibrated, in the solar system barycentric frame:
HARPS.2003-11-01T02:40:09.824_s1d_A.fits

- Bisector from the cross-correlation computed with a G2 mask:
HARPS.2003-11-01T02:40:09.824_bis_G2_A.fits

- Sample of Th lines intensities and FWHM (only for TH calibration frames):
HARPS.2007-02-11T20:21:01.144_spot_thAB.tbl

Other summary tables are produced at the end of each night:

- **cal_loc.ONE.result.tbl**: order localization table;
- **cal_FF.result.tbl**: flat field table;
- **cal_TH.result.tbl**: Thorium table (for wavelength calibrations);
- **drift.result.tbl**: Th lines drift in m/s measured on fiber B, filled only in the simultaneous reference mode;
- **CCF.results.tbl**: results of the CCF, with measured RV and RV sigma, filled only when the *RADVEL* field in the template is different by -99999.

All files with extension “.tbl” are ASCII files, not MIDAS tables!

7.2.2 Data archiving

HARPS raw data are compliant with the requirements of ESO’s Data Interface Control Board (DICB). They are stored locally at La Silla and in the central Garching Science Archive (<http://archive.eso.org/>).

HARPS data can be requested from the Garching Science Archive. Data taken by observers in Visitor Mode are subject to the usual proprietary period of 1 year.

According to the Agreement between ESO and the HARPS Consortium the data taken by the Consortium during their Guaranteed Time are subject to special protection:

- Raw data and reduced spectra ($I=f(\lambda)$) in the Earth reference frame at the time of the observation will be made public one year after observations
- All raw data and radial velocity measurements obtained by the Consortium will be made public one year after the end of the 5 year Guaranteed Time period.

In practice this means that data obtained by the Consortium can be requested from the Garching Science Archive as usual one year after the observations. However, in order to make recovery of precise radial velocities impossible, the keywords containing information about the exact time of the observations will be filtered from all file headers (raw and reduced) by the Archive during the de-archiving process.

Appendix A

Description of Archived HARPS Data

A.1 Data naming rules

The raw frames are stored in FITS format by the DFS with the ESO-VLT standard naming rules: `HARPS.YYYY-MM-DDTHH:MM:SS.SSS.fits` with `YYYY-MM-DD` and `HH:MM:SS.SSS` being respectively the date and time of the start of the observation. Raw frames are written in extended fits format, each CCD being on a different plane of the frame. This is effective as of January 1st, 2004.

Pipeline products are stored in FITS format with the same generic names plus an additional suffix describing its format (see next section for details) and the specific fibre name (A or B). For example: `HARPS.YYYY-MM-DDTHH:MM:SS.SSS_E2DS_A.fits` is an E2DS format image of the fibre A product by the DRS derived from the `HARPS.YYYY-MM-DDTHH:MM:SS.SSS.fits` raw frame.

Tables in ASCII format are also produced by the DRS.

The relevant log-books of the DRS is named `DRS-whadrs.YYYY-MM-DD`. It is stored with all the other logs in the `/msg` directory. It is automatically archived in the ESO Science Archive Facility (<http://archive.eso.org/>).

A.2 Data formats

A.2.1 Raw frames

The raw frame corresponds to a 4296×4096 integer (35'242'560 bytes) matrix written on disk in extended FITS format (see Fig. A.1), each CCD being on a different plane of the frame. This image includes a 4096×4096 sensitive zone plus 4 overscan zones of 50 pixels each. The following generic descriptors are used by the DRS:

MJD-OBS	Modified Julian Day start [float]
EXPTIME	Total integration time (s) [float]
DATE-OBS	Date and Time of observation [string]
RA	RA of the target [float]
DEC	DEC of the target [float]
EQUINOX	Equinox of observation [float]

The DRS needs as well the following **HIERARCH ESO** descriptors:

DET1 READ SPEED	CCD Readout mode (speed, port and gain) [string]
DET OUTi GAIN	Conversion from electrons to ADUs of port i [float]
DET OUTi RON	Readout noise of port i (e-) [float]
DET WIN1 DIT1	Actual sub-integration time (s) [float]
DET WIN1 DKTM	Dark current time (s) [float]
DET DPR CATG	Observation category [string]
DET DPR TYPE¹	Observation type [string]
INS DET1 TMMEAN	Normalized mean exposure time on fibre A [float]
INS DET2 TMMEAN	Normalized mean exposure time on fibre B [float]
INS OPTI5 NAME	Lamp name on fibre A [string]
INS OPTI6 NAME	Lamp name on fibre B [string]
OBS NAME	OB Name [string]
OBS START	OB Start Date and time [string]
TPL ID	Template signature ID [string]
OBJECT TYPE²	What is on fibre A and B [string]
OBJECT SP²	Object spectral type [string]
OBJECT RV³	Object expected RV [string]
TEL TARG RADVEL⁴	Object expected RV [string]

¹ the use of this keyword made by the DRS is wrong, the keyword shall be later replaced by OBJECT TYPE (not yet implemented by the DICB);

² shall replace some of the DPR TYPE current function, not implemented yet in the DICB;

³ not implemented yet but needed for optimum RV computation;

⁴ this keyword shall be later replaced by OBJECT RV

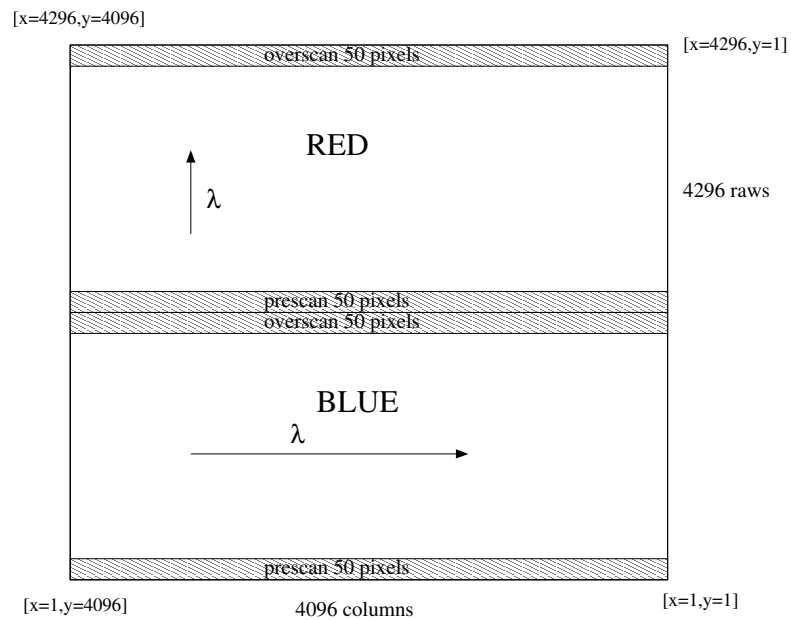

Figure A.1: Raw frame format.

Appendix B

List of Acronyms

ADC	Atmospheric Dispersion Compensator
AG	Auto-Guider
BOB	Broker of Observing Blocks
CCD	Charge Coupled Device
CCF	Cross-Correlation Function
CES	Coude Echelle Spectrograph
CFC	Continuous Flow Cryostat
CU	Calibration Unit
DAU	Data Archiving Unit
DFS	Data Flow System
DHS	Data Handling System
DICB	Data Interface Control Board
DIMM	Differential Image Motion Monitor
DRS	Data Reduction Software
E2DS	Extracted 2-Dimensional Spectrum
ESO	European Southern Observatory
ETC	Exposure Time Calculator
FIERA	(name for ESO's standard CCD controller)
FITS	Flexible Image Transport System
HCFA	HARPS Cassegrain Fibre Adapter
HARPS	High Accuracy Radial velocity Planet Searcher
ICS	Instrument Control Software
IP	Instrumental Profile
IWS	Instrument WorkStation
ND	Neutral Density
NGAS	Next Generation Archive System
NOB	New Operation Building
NTT	New Technology Telescope
OB	Observing Block
OG	Observatoire de Geneve
OS	Observation Software
P2PP	Phase 2 Proposal Preparation
PSF	Point Spread Function
RTD	Real Time Display
RV	Radial Velocity
S/N	Signal to Noise Ratio
TBC	To Be Confirmed

TBD	To Be Determined
ThAr	Thorium Argon
TIO	Telescope and Instrument Operator
UVES	Ultraviolet/Visible Echelle Spectrograph
VA	Visiting Astronomer
VLT	Very Large Telescope
XTC	eXtended exposure Time Calculator

--Ω--